



ATI'S UNIQUE **SUPPLY**  
CHAIN DELIVERS **VALUE**  
FOR OUR CUSTOMERS  
AND **PROFITABLE**  
**GROWTH** FOR  
OUR STOCKHOLDERS

Ti  
22

Ni  
28

Co  
27

W  
74

Zr  
40

Nb  
41

Hf  
72



2011



## CONTENTS

FINANCIAL REVIEW	1
MESSAGE FROM THE CHAIRMAN, PRESIDENT AND CHIEF EXECUTIVE OFFICER	3
INTEGRATED AEROSPACE SUPPLY CHAIN	8
AEROSPACE ENGINES	10
INTEGRATED OIL & GAS SUPPLY CHAIN	12
WHAT WE MAKE AND WHERE IT GOES	14
ATI PRODUCTS AND MARKETS	16
SEGMENT INFORMATION	17
GLOSSARY OF TERMS	18
CORPORATE SELF-GOVERNANCE	20
ANNUAL REPORT ON FORM 10-K	F1
MANAGEMENT TEAM	21
BOARD OF DIRECTORS	22
INVESTOR INFORMATION	23



### About the Cover

ATI Pacific Cast Technologies Brian Lucero conducts an ultrasonic and visual inspection of a large titanium investment casting destined for an aerospace engine.





	2011	2010	2009	2008	2007
<b>Sales</b>	\$5.2 billion	\$4.0 billion	\$3.1 billion	\$5.3 billion	\$5.5 billion
<b>Segment Operating Profit</b>	\$612.0 million	\$356.5 million	\$282.2 million	\$944.9 million	\$1,273.2 million
<b>Net Income Attributable to ATI</b>	\$214.3 million	\$70.7 million	\$31.7 million	\$565.9 million	\$747.1 million
<b>Net Income per Common Share</b>	\$1.97	\$0.72	\$0.32	\$5.67	\$7.26
<b>Gross Cost Reductions<sup>(1)</sup></b>	\$124 million	\$135 million	\$173 million	\$134 million	\$112 million
<b>Managed Working Capital as % of Annualized Sales<sup>(2)</sup></b>	37.8%	34.4%	34.5%	35.2%	32.2%
<b>Net Debt<sup>(3)</sup></b>	\$1,128.7 million	\$631.0 million	\$362.3 million	\$39.9 million	\$(95.1) million
<b>Net Debt as % of Total Capitalization<sup>(4)</sup></b>	31.3%	23.6%	15.3%	2.0%	(4.5)%
<b>Capital Investments and Asset Acquisitions</b>	\$1,175.8 million	\$219.1 million	\$454.3 million	\$515.7 million	\$457.1 million

(1) Before the effects of inflation.

(2) Represents accounts receivable and gross inventory less accounts payable, excluding LIFO inventory reserves and other allowances. Sales annualized for last two months of the period.

(3) Represents total debt less cash and cash equivalents.

(4) Total capitalization is comprised of net debt plus total ATI stockholders' equity.

Top left: Senior Plasma Melter Lonnie Bowman looks through a viewport and instructs plasma control room operators on plasma torch position settings during the start-up of the PAM-4 furnace at ATI's Bakers, NC melting operations.

Bottom left: Investment casting begins in the wax assembly room at ATI Pacific Cast Technologies. ATI Wax Assembler Mary E. Copeland joins several separate wax components to create a complete wax model. These wax models embody the effective combination of part design, die design, and molten metal solidification modeling.

Below left: Sam Menzie, Operator Leader, in the ESR furnaces control room at ATI's Latrobe, PA operations.

Below right: X-ray analysis is one of several techniques employed by ATI Pacific Cast Technologies to assure the surface, internal integrity and dimensional excellence of its products. ATI Technician Clayton Roth Jr. adds a visual inspection to his analysis of an X-rayed near-net-shape titanium cast component.



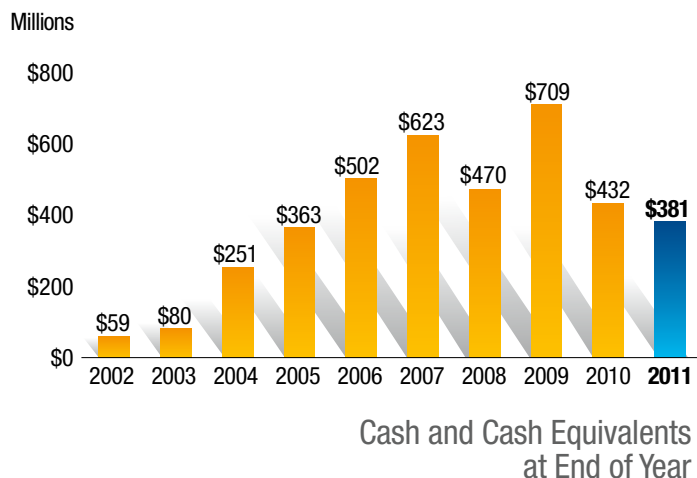
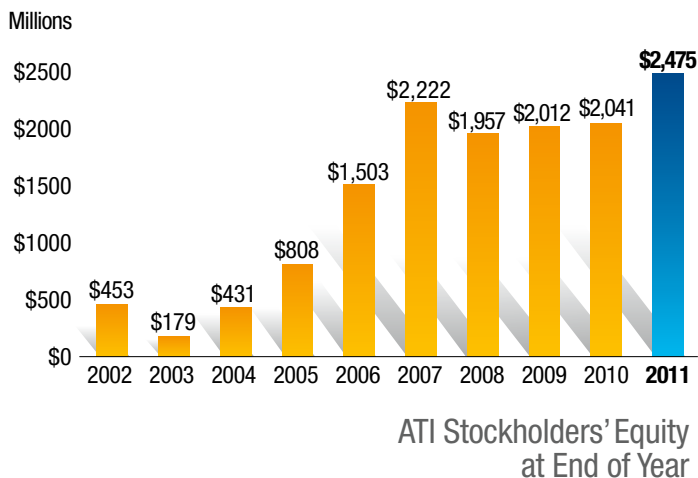
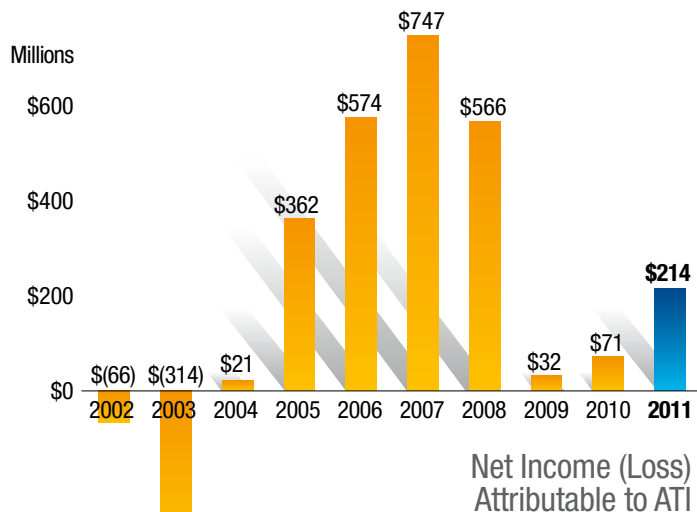
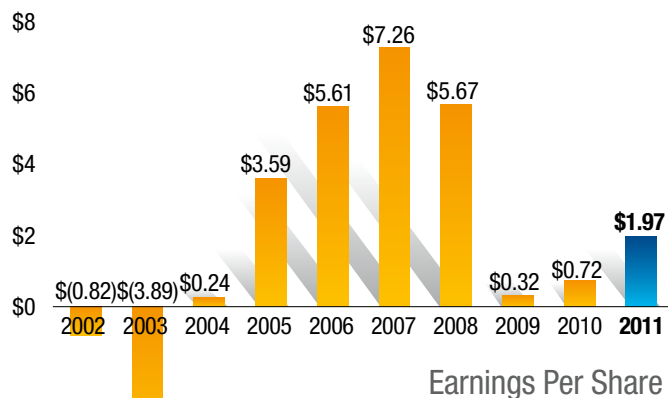
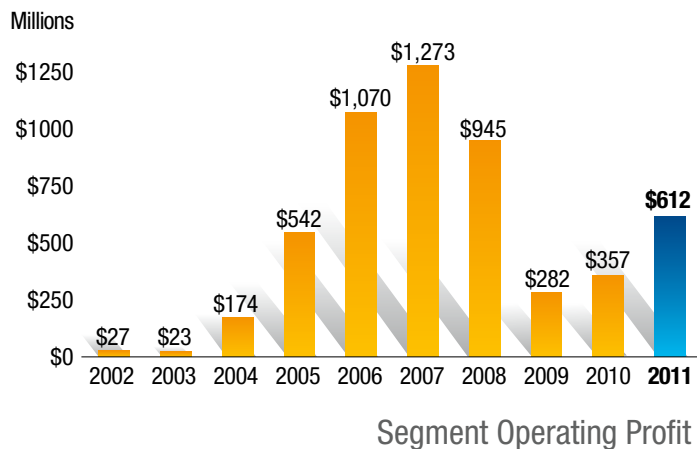

## Creating Value for Our Customers and Stockholders

### In 2011, Secular Growth Resumed in Our Key Markets

2011 was a much better year for ATI. As we entered 2011, it was our view that the year would be marked by the resumption of secular growth in our key global markets. This was realized in spite of the choppy recovery in the U.S. economy and the mostly unanticipated impact from euro-zone sovereign debt issues. Our focus on product and market diversification and a higher-value product mix, both of which are key parts of ATI's strategy, enabled ATI to achieve profitable growth in spite of a sluggish recovery in some of our short-cycle markets, particularly during the second half of 2011.

Revenues grew 28% over 2010 to nearly \$5.2 billion. Growth in our key markets combined with the May 2011 Ladish acquisition more than offset reduced demand and historically low base prices for our standard stainless products. Our key global markets, namely aerospace and defense, oil & gas/chemical process industry, electrical energy, and medical, represented 70% of ATI sales in 2011. Growth in these key markets continued to be strong and sales were 33% higher than in 2010. Sales to the aerospace and defense, oil & gas/chemical process industry, electrical energy, and medical markets grew 44%, 41%, 16%, and 8%, respectively.

Segment operating profit, excluding inventory fair value accounting costs associated with the Ladish acquisition, was \$639 million, or 12% of sales. Earnings per share, excluding special charges, was \$2.23, which is 210% higher than 2010. Earnings per share including special charges was \$1.97, nearly 175% higher than 2010.

Our financial position remains solid with cash on hand of over \$380 million at the end of 2011 and net debt to total capitalization of approximately 31%. Capital expenditures were \$278 million in 2011, and we invested \$273 million in managed working capital to support growth in our business.

On May 9, 2011, ATI completed the acquisition of Ladish Co., Inc. for \$897.6 million, comprised of the issuance of 7.3 million shares of ATI common stock and payment of \$384 million in cash. ATI Ladish post-acquisition results are included in our High Performance Metals segment.

Our strategy takes a long-term view while maximizing near-term performance, meaning that we manage the Company to maximize the short-term opportunities without losing sight of our long-term profitable growth strategy. We are a profitable company with a strong balance sheet, which enables ATI to continue our investments in new manufacturing capabilities, innovative new products, and global marketing initiatives.

We believe in American manufacturing. We have approximately 11,400 full-time employees, 86% of whom are located in the U.S., who manufacture diversified specialty metals products for a diverse array of end-use markets including, aerospace and defense, oil and gas/chemical process industry, electrical energy generation and distribution, medical devices and equipment, automotive, food equipment and appliances, machine and cutting tools, and construction and mining equipment.

We are fortunate that, at this time, we are one of the few companies in the world who can produce the specialty metals that can stand up to such critical applications. We understand that the ability to manufacture these critical specialty metals is a core competency of the United States. To that end, since 2004, we

have invested over \$3.3 billion in capital expenditures and asset acquisitions. ATI has self-funded approximately 75% of these investments with the cash flow generated by our businesses. We have created nearly 1,800 new jobs in just the last two years.

Our direct international sales were 35% in 2011, and we are proud that a U.S. manufacturer can achieve that level of international sales. We are also proud to support our domestic customers who make important products in the U.S. for domestic and global markets – including such products as airplanes and jet engines, industrial gas turbines for electrical power generation, oil and gas equipment, and medical devices.

### 2011 Major Accomplishments

We understand that industry leadership and competitive advantage exist only for a period of time. Status quo loses. ATI is not the same company it was five years ago, and to be successful five years from now, ATI cannot be the same company that it is today.

Our ability to manufacture industry-leading mill products, near-net shapes, and components made from Mission Critical Metallics®, such as titanium and titanium alloys, nickel-based alloys and superalloys, specialty alloys, and zirconium alloys, for our key markets positions ATI with a unique supply chain that provides value to our customers and creates value for our stockholders. We must continue to invest in unsurpassed manufacturing capabilities and innovative new products to maintain and enhance ATI's position as a global leader in specialty metals.

Major accomplishments in 2011 that support our strategy include:

- ▶▶▶ The acquisition of ATI Ladish was completed and integration began immediately. With the forging, casting and machining capabilities of ATI Ladish, we are now integrated in titanium alloys, nickel-based alloys, and specialty alloys from raw materials (titanium sponge) through melting and forging of mill products and complex shapes, to forged and investment cast parts and components. Many of our OEM customers tell us that they value a seamless, real supply chain over a virtual supply chain with multiple producers involved. Being integrated from alloy development and melt through the forging, casting and machining of the final part is now a strength of ATI. We have a growing reputation as the technology leader who can provide customers with the seamless product development and manufacturing capabilities they need now and in the future.
- With ATI Ladish, we add isothermal forging, hot-die forging, and large complex investment castings to our list of unsurpassed manufacturing capabilities. These are the processes required to make the advanced components for the next-generation and future-generation jet engines. We also add forging capabilities in Poland, in an area that is a fast-growing region of the global aerospace industry supply chain.
- Synergy teams are working on identified opportunities to bring more ATI specialty metals and cutting tools into ATI Ladish. We have a closed-loop raw material supply chain as Ladish revert material is recycled through ATI melting facilities.



*ATi Management's Executive Committee (left to right): John Sims, Carl Moulton, Terry Dunlap, Hunter Dalton, Rich Harshman, Gary Vroman, Elliot Davis, Dale Reid, Dave Hogan.*

- A significant benefit from combining ATi's leading melting and hot working mill products technologies and capabilities with ATi Ladish forging and casting capabilities is the real-time technology information exchange. We believe this transparent technology exchange can create better products, improve productivity, reduce costs, and compress the time of alloy and product development.
- » Significant progress was made throughout 2011 as we began production at our Rowley, UT premium-titanium sponge facility. We expect to complete the standard grade qualification process by the end of the first quarter 2012, and we will then proceed with the premium grade qualification process.
- » Production began at our new Plasma Arc Melt (PAM) premium-titanium furnace located in Bakers, NC. This now gives ATi the capabilities of four PAM furnaces.
- » Construction began at the L. Patrick Hassey Hot Rolling and Processing facility located in Brackenridge, PA. This project is expected to cost approximately \$1.1 billion and is scheduled for completion by the end of 2013, with cold and hot commissioning scheduled for 2014. It is designed to be the most powerful mill in the world for manufacturing flat-rolled specialty metals. We expect expanded capabilities, improved productivity, lower costs, faster manufacturing cycle times, and higher quality for our diversified product mix of nickel-based alloys, titanium and titanium alloys, specialty alloys, zirconium alloys, and stainless steels. This investment creates significant profitable growth opportunities for all of ATi's flat-rolled products.
- » In 2011, we improved our cost structure with nearly \$124 million in gross cost reductions. This brings our eight-year total to over \$1.1 billion in gross cost reductions, before the effects of inflation. Improving our cost structure is part of ATi's DNA. We set cost reduction targets in each year of every business cycle. We understand that continuous improvement is a race without a finish line. Great companies, particularly a U.S. manufacturer doing business throughout the world, must not only keep costs under control, but must get better each year.





## Differentiated Markets with Good Secular Growth Trends

Our strategy is to identify secular growth trends in the global economy that have a meaningful impact on the use of our products. Even as we see short-term economic cycles in the world, we continue to believe that the world's population is growing and more people are moving into an expanded middle class. The commercial aerospace market is in an extended period of unprecedented demand for fuel-efficient airplanes, both to accommodate the world's growing middle class and to provide replacement aircraft to legacy fleets. In addition, our products are vital to building the global infrastructure in such markets as oil and gas/chemical process industry, and electrical energy. Demand for our products from the medical market is being driven by the expansion of procedures for aging population demographics and the growing need for advanced medical equipment and care in developing economies.

These secular growth markets are not solely dependent upon strong short-term GDP growth cycles in any one economy as was evident by our 2011 results. Rather, the markets are responding to a long-term demographic shift and long-term infrastructure building and rebuilding occurring on a global basis.

## Strong Demand for Fuel-Efficient Airplanes

We are well-positioned to support our customers in the expected biggest and longest aerospace cycle in history. The OEMs have historic backlogs. The need for fuel-efficient and cost-efficient airplanes and jet engines is expected to continue to drive demand for many years. In 2011, the transition to much higher build rates began at both Boeing and Airbus. Boeing delivered the first 787 Dreamliner, the first 747-8 cargo plane, and sold more 777s than ever before.

The Boeing 737Max and Airbus A320neo single aisle airplanes with future-generation engines were both successfully announced and significant orders were received. These new airplanes will use jet engines that require even more advanced titanium alloys and nickel-based alloys to withstand the greater pressures and higher temperatures needed for the improved fuel efficiency demanded by global carriers.

Orders placed in 2011 combined with the historic OEM backlogs are expected to create demand for our specialty metals and components for many years. First, we are seeing the increase in build rates for legacy airplanes such as the B737, A320, B777, and A330 to unprecedented levels. At the same time, we are seeing the ramp-up in production rates for the 787 Dreamliner and the 747-8. The entry-into-service of the Airbus A350XWB is currently scheduled for 2014. In addition, the future-generation single aisle aircraft are in the design engineering stage. This is a great time to be considered a technology leader for the wide range of advanced specialty metals required by all of these airplanes and their jet engines.

## Strong Demand for Oil and Gas, Chemicals, and Clean Water

Most forecasts indicate an extended period of investment to explore and recover oil and gas deposits around the world. Development of large deep-water oil and gas fields is expected to continue for many years. We are seeing an historic shift taking

## ATI's Strategy is to Create Value Through Sustainable Profitable Growth

- » Identify differentiated markets with good secular growth trends
- » Focus on key global markets
- » Invest in unsurpassed manufacturing capabilities
- » Develop and introduce innovative products
- » Continue to focus on lean manufacturing and cost reduction

place – oil and gas exploration and increased production is moving to OECD countries to reduce risk. New advanced technologies, such as horizontal and directional drilling, are helping to enable this shift by creating access to new oil and gas deposits. Horizontal drilling is gaining share of the global rig count as the development of shale oil and gas moves from the U.S. to many other areas of the world.

The need for our products grows even faster as the search for energy moves to ultra-deep water, deep subsalt high-temperature high-pressure wells, severely sour oil and gas, and unconventional processes requiring directional and horizontal drilling.

In 2011, our ATI nickel-alloy plate and sheet was used for large sour gas field projects in Saudi Arabia, Abu Dhabi, Australia, and Brazil. We received Norsok (Norwegian petroleum industry standard) requalification for our family of duplex alloys (ATI 2003® lean duplex, ATI 2205™ duplex, and Zeron® 100 superduplex), our super austenitic alloy AL-6XN® alloy, and titanium castings. Robust demand continued from horizontal and directional drilling service for ATI Datalloy 2® stainless and ATI tungsten materials for use in earth-boring bits.

In addition, infrastructure development is continuing to emerge for consumption of lower cost natural gas by petrochemical plants that use our alloys that withstand the corrosive and hot environments of these facilities.

In 2011, we produced and delivered the largest industrial titanium sheet order in the history of ATI to be used in the world's largest seawater desalination plant. We expect the need for clean water to continue to grow and drive demand for many of our corrosion-resistant alloys.

## Growing Demand for Safe, Clean and Efficient Electrical Energy

According to the International Energy Agency (IEA), the world faces enormous energy challenges in the future. Demand is expected to rise 35% over the next 25 years with investment in energy infrastructure to average approximately \$1.5 trillion a year for decades. Competing energy sources, such as nuclear, coal, natural gas, and oil, are expected to comprise the primary base load power generation. The largest market demand is predicted to be in China, India, South Korea, and a few countries in the Middle East. In the United States, energy growth is being impacted by the new economics of natural gas power generation. Renewables, such as solar, wind, and geothermal, are projected to gain the most share, but remain below 15% of total world power generation.

Public reaction to the 2011 Fukushima nuclear power plant accident in Japan has slowed the renaissance for new nuclear power plants. The accident has focused attention on nuclear power plant safety and design upgrades to existing reactors and has increased political pressure to find a solution for spent nuclear fuel. ATI is well positioned in the global nuclear electrical energy market. ATI has a broad range of nuclear-energy certified corrosion-resistant alloys that are used in power plant reactors, water systems, and spent nuclear fuel applications.

In the United States, public opinion, new EPA (Environment Protection Agency) rules, and the new economics of natural gas power generation are leading to potential demand for ATI products for pollution control systems and specialty metals used in industrial gas turbines. Demand for ATI's corrosion-resistant alloys is growing for tubing used for solar power and geothermal applications. We are working on several promising new technologies for solar power generation and storage. In addition, we have begun to see some improvement in demand for wind energy applications.

Finally, one way to reduce power generation requirements is to improve the efficiency of electrical energy grid. Our grain-oriented electrical steel is used in power generation transformers. The new, efficient transformers use our M2 and M3 grades to meet the U.S. Department of Energy efficiency standards.

“ATI is not the same company it was five years ago, and to be successful five years from now, ATI cannot be the same company that it is today.”

### Strong Demand for Improved Medical Devices and Equipment

Demand for our products from the medical market continues to be strong due to the aging U.S. and European populations and the expansion of medical equipment and devices to the developing world. Strong demand for implantable metallic biomaterials is being driven by the aging population who want to remain active. Our customers are also seeing demand growth for a broader global population for total joint replacement, fracture fixation, pacemakers, and spinal implants that use our broad range of high-end medical alloys.

ATI is well positioned to grow in this market due to increasingly stringent quality specifications that, in many cases, require our unsurpassed manufacturing capabilities, such as our PAM premium-titanium melt furnace that provides the highest quality titanium product. We remain active in product innovation in the medical market and have received good response to our ATI-15Mo™ titanium alloy and our other improved biocompatible beta titanium alloys for high-cycle fatigue structural implants. Our new ATI35N Lo Ti™ nickel-cobalt-based alloy has also received good customer response. It is designed to meet the high fatigue strength demands for biomedical applications.

Demand for our niobium titanium alloys continues to be strong for use in the next-generation MRI (Magnetic Resonance Imaging) equipment. The 3 Tesla models provide twice the magnetic field strength compared to the conventional 1.5 Tesla models, allowing for a significantly improved image.

### Product and Process Innovation

Innovation is essential in our business. This is an exciting time to be a leader in specialty metals as our customers invent new airplanes and jet engines, search for energy in more difficult environments, improve efficiency in transportation and electrical energy, and produce products that work better and last longer.

Our strategy is to innovate faster than our competition in order to maintain and enhance our technology leadership. We have identified nearly \$2 billion in potential new annual revenue growth over the next five years from our new manufacturing capabilities and innovative new products. There is innovation and then there is game-changing innovation. We focus on both.

To meet the ever increasing demands of our customers, we need unsurpassed manufacturing capabilities to achieve the process complexities of the new alloys. For example, while the traditional titanium alloy for jet engines has been 6-4 titanium, the next-generation and future-generation jet engines require more ATI 17™ alloy, ATI 6-2-4-2™ alloy, and titanium aluminides. Similarly, while the workhorse nickel-based superalloy has been 718, hotter-burning, next-generation and future-generation jet engines require ATI 718Plus® alloy, ATI 720™ alloy, powder metals, as well as other new ATI proprietary alloys. In June 2011, we signed a long-term agreement with Rolls-Royce to supply ATI 718Plus alloy for rotating parts. We also have a long-term supply agreement for this innovative new alloy with GE Aviation. ATI 718Plus alloy is being used in many legacy and next-generation jet engines where standard 718 alloy would be pushed beyond its capabilities.

ATI continues to expand our product portfolio, targeting difficult-to-manufacture nickel-based alloys needed for the current and next-generation jet engines and electrical energy turbines. Our new TSAF (Titanium and Superalloy Forging) facility in Bakers, NC, which is the largest and most powerful in our industry, enables development of larger ingots and billets of more complex superalloys that allow new engines to burn hotter in order to meet stricter efficiency requirements.

“The addition of ATI Powder Metals and ATI Ladish has created new opportunities for collaboration and development, bringing ATI closer to the end users.”

The addition of ATI Powder Metals and ATI Ladish has created new opportunities for collaboration and development, bringing ATI closer to the end users. We are now able to bring our next-generation of products for aerospace to market faster and at a better value proposition for our customers. One tool we use is modeling to estimate microstructural evolution from raw materials to finished components. We can run multiple trials, examining the effects of a variety of conditions and find the optimal solution to reach the required material condition.





Significant progress has been achieved in the commercialization of ATI 425<sup>®</sup> alloy within the aerospace market. Work conducted by aerospace OEMs and Tier 1 suppliers has confirmed that ATI 425 alloy provides super plastic forming (SPF), hot forming and diffusion bonding at lower temperatures, compared to 6-4 titanium alloy. This characteristic leads to a lower overall cost to manufacture the part or fabricated component.

ATI 2102<sup>®</sup> Lean Duplex Alloy is a new addition to our family of duplex alloys. ATI 2102 alloy contains less nickel and molybdenum than our other lean duplex alloy, ATI 2003<sup>®</sup> alloy. ATI 2102 alloy has been selected for applications in the oil and gas market.

We have developed a new line of borated stainless steels that begin with our powder metals and are available in plate and sheet product forms. A primary use of this alloy is for spent nuclear fuel storage applications.

## 2012 Outlook: Strong Secular Growth Continues

**S**trength in our key growth markets continues to give us confidence for 2012 and beyond. While macroeconomic challenges and uncertainties exist, we are cautiously optimistic about 2012. ATI's diversification, focus on differentiated growing global markets, commitment to new product and technology development, and unsurpassed manufacturing capabilities and continued focus on cost reductions and manufacturing efficiencies are critical to our growth strategies. While secular growth trends remain intact in our key global markets, we are cautious on the recovery in our short-cycle markets and are awaiting further evidence to show sustainable improvement in the U.S. unemployment rate and consumer confidence. We also await favorable resolution of the euro-zone debt issues.

In our High Performance Metals segment, we expect to benefit from growing demand in our key global markets, increasing synergies at ATI Ladish, improving cost structure at our Rowley, UT titanium sponge facility, additional premium-titanium PAM capacity, and increasing demand for our new alloys and products.

In our Flat-Rolled Products segment, we expect to continue to benefit from growing demand for many of our high-value products from our key growth markets. We also believe that demand from the automotive market can be much better in 2012 than it has been since the last strong auto cycle in 2007. We also expect improved demand for our products from the transportation market for rail cars and truck trailers.

In our Engineered Products segment, we expect demand to continue to be strong from three of this segment's largest markets, which are oil and gas, construction and mining equipment, and aerospace.

## Positioned to Capitalize on What We Do Well

**W**e are positioned to capitalize on what we do well. Our future is being invented by the people of ATI, and we expect to benefit from our technology and product diversification, both in terms of alloys and product forms. ATI has long been a leader in specialty metals technology and our capital investments and new alloy innovations are aimed at maintaining and enhancing our mission-critical role.

Our future is being driven by the demands of the world's citizens – for mobility, manufactured goods, clean air and water, and a modern infrastructure – and by our customers who make the products to meet these demands. ATI is focused on developing the technology and products that enable social progress and industrial development throughout the world.

We have a defined view of the future and we have the financial means and people to continue to move ATI forward.

## Value-Based Leadership

**V**alue-Based Leaders are the true difference in companies that move people to new levels of achievement and success. To move our Company forward, I look for the leaders within ATI who demonstrate commitment to these key core values:

- **Integrity as the Cornerstone of our business.** To that end, we must be honest and forthright in everything we do.
- **We expect everyone to be treated with dignity and respect and we embrace the values of cooperation, diversity, and teamwork.**
- **ATI is committed to more than just adherence to laws and regulations.** Our commitment is to reflect the highest level of integrity and ethics in our dealings with each other, our customers, our suppliers, our stockholders, the public, and the government agencies with whom we engage.
- **Personal accountability** for outcomes ensures the long-term success of ATI.
- **Safety, Health and Environmental Compliance** are the prerequisites to all operations, and our goal is to finish each day incident- and injury-free.
- **Product Quality and Excellence** is demonstrated in everything we do.
- **Technology, Creativity, Learning, and Freedom of people to reach their individual potential** is ATI's culture.

Our commitment to Do What's Right<sup>®</sup> continues to guide us throughout our global operations and business activities.

In *Building the World's Best Specialty Metals Company*<sup>®</sup>, we aim to do more, make our products better, and implement and execute faster through the ATI Business System (ATIBS). ATIBS drives our lean manufacturing initiatives, improves safety, quality and yields, leads to improved productivity and cost efficiencies, and delivers excellent customer reliability and service.

I want to personally thank our stockholders, our employees, our suppliers and the communities in which we operate our businesses for their continued support of ATI.

I would also like to thank our Board of Directors for their advice, counsel, and continued support of our efforts to create long-term sustainable value for our customers and stockholders.

Richard J. Harshman  
Chairman, President and Chief Executive Officer



# INTEGRATED AEROSPACE SUPPLY CHAIN

## Maximizing Performance Through Materials & Manufacturing Know-How

Since 2004, ATI has been transformed by investing over \$3.3 billion in capital expenditures and asset acquisitions. We are now integrated in titanium alloys, nickel-based alloys, and specialty alloys from raw materials (titanium sponge) through melting and forging of mill products and complex shapes, to precision machined forged and investment cast parts and components. We offer our aerospace customers a seamless, real supply chain.



### Raw Material

ATI has two titanium sponge facilities that are planned to produce premium-quality and standard-quality titanium sponge when qualified.



### Melt & Remelt

Titanium products are melted and refined using PAM, EB, and VAR. Nickel-based alloys and specialty alloys use a VIM (Vacuum Induction Melt) to VAR remelt path.



### PAM

Plasma Arc Melt is a superior cold-hearth melt process for making premium-titanium alloys for aerospace jet engine, medical and other critical applications.



### EB

Electron Beam melt is used to produce large ingots and slabs of both CP titanium and alloy titanium.



### VAR

Vacuum Arc Remelt is a consumable remelting process that is used in the primary melt of titanium alloys and in the refining process of nickel-based alloys and specialty alloys.



### Powders

Advanced and complex nickel-based superalloys can be produced as powders including the steps of atomizing, screening, blending, and pressing to consolidate metal powders.



### Press Forge

ATI has a variety of forging capabilities. Our newest press forge is rated at 10,000 tons of force and is the most powerful in our industry.



### Radial/Rotary Forge

ATI also has a variety of rotary and radial forging capabilities. Our newest such asset is a 700mm radial forge and is the largest such forge in the world for producing our specialty alloys.



### Rolling Mill

ATI's long-products rolling mill is the most modern and most versatile of its kind. It produces titanium alloy, nickel-based superalloy, and specialty alloy bar, rod and coil products.



### Isothermal Forge

The primary advantage of isothermal forging is closer tolerances and the ability to forge complex alloys. ATI has the world's largest isothermal forge presses.



### Investment Castings

Titanium investment casting is designed to achieve high dimensional accuracy. ATI has the capability to design components with intricate geometries, cored passageways, cast-in features, and sculpted surfaces.

Titanium Alloys

Nickel-Based Alloys

Specialty Alloys





**Billet**



**Bar**

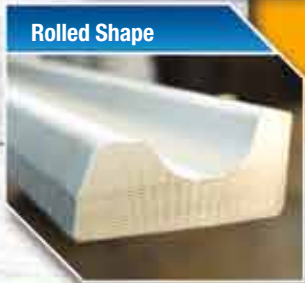

**Rolled Shape**



**Cast Components**



**Forged Components**



**Fastener Stock**



### Precision Machining

Through our Ladish acquisition, ATI now has extensive capabilities in precision machining for aerospace parts.



### Machining & Finishing

ATI provides customers with value-added near-net-shape products. For the aerospace supply chain, we provide machined components such as jet engine shafts.



### Cutting Tools

ATI designs and develops tooling and cutting tool systems to meet the needs of our aerospace supply chain customers.



**Large Commercial Aircraft**



**Single-Aisle Commercial Aircraft**



**Jet Engines**



**Defense Aircraft**



**Rotary Aircraft**

**W** Tungsten Products

MISSION CRITICAL METALLICS



# Mission Critical Metallics® for Aerospace

## Fasteners

- ATI 6-4™ Titanium
- ATI 425® Titanium
- ATI 45Nb™ Titanium
- ATI 718™ Nickel
- ATI 718Plus® Nickel
- ATI 17-7™ Stainless
- ATI A286™ Steel

## Honeycomb, Bellows, Insulation & Tubing

- ATI 6-4 ELI™ Titanium
- ATI 3-2.5™ Titanium
- ATI 6-2-4-2™ Titanium
- ATI 425® Titanium
- Orthorhombic Ti Aluminide
- ATI 718™ Nickel
- ATI 718Plus® Nickel
- ATI 600™ Nickel
- ATI 625™ Nickel
- ATI HX™ Nickel
- ATI 15-7™ Stainless
- ATI 21-6-9™ Steel
- AM 350® Steel
- ATI A286™ Steel

## Fan: Disks, Rotor, Blades & Casings

- ATI 6-4™ Titanium
- ATI 6-2-4-2™ Titanium
- ATI 17™ Titanium

## APU Disk

- ATI 720 PM™ Nickel
- Low Carbon Astroloy

## Exhaust Cones, Mufflers & Thrust Reversers

- ATI 718™ Nickel
- ATI 718Plus® Nickel
- ATI 617™ Nickel
- ATI 625™ Nickel
- ATI HX™ Nickel
- ATI C-103™ Niobium

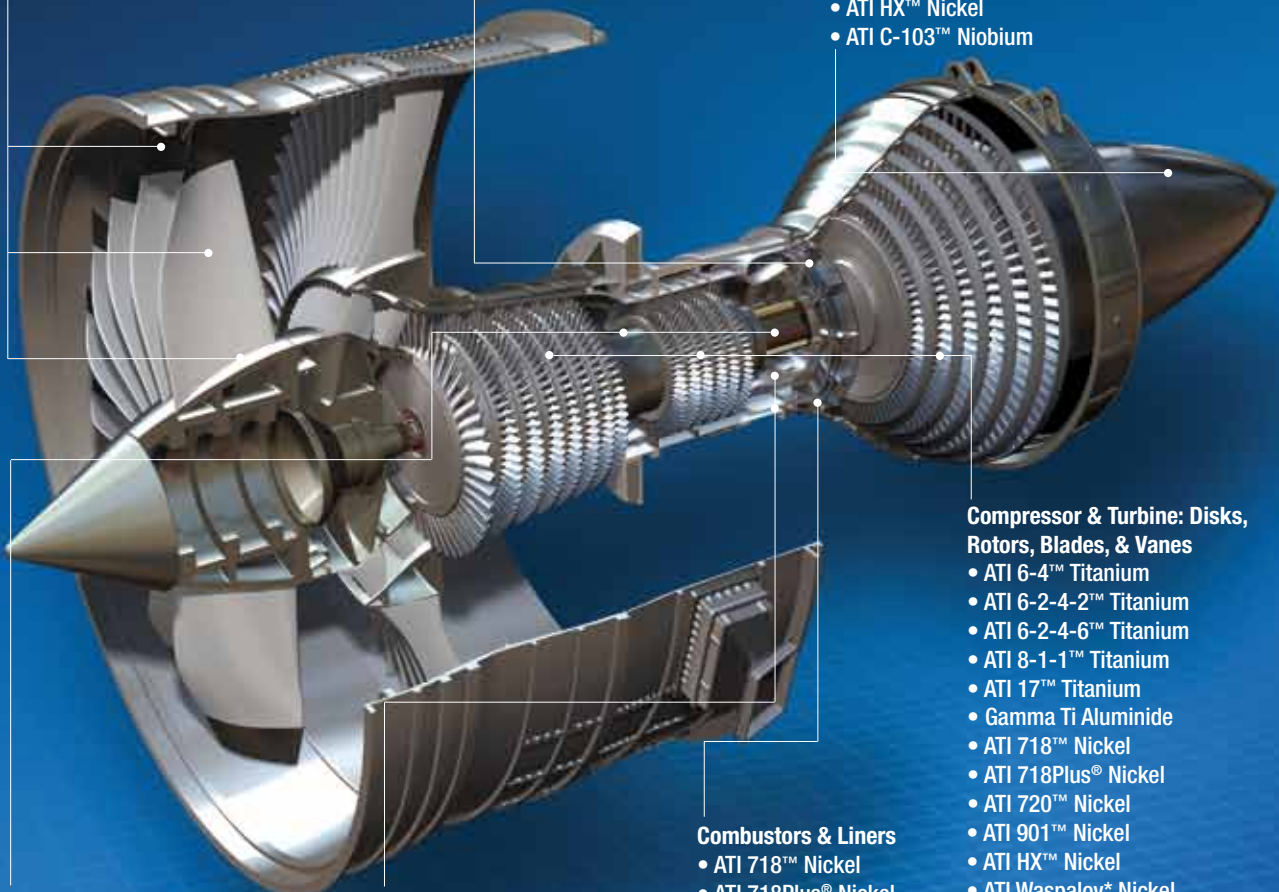

## Compressor & Turbine: Disks, Rotors, Blades, & Vanes

- ATI 6-4™ Titanium
- ATI 6-2-4-2™ Titanium
- ATI 6-2-4-6™ Titanium
- ATI 8-1-1™ Titanium
- ATI 17™ Titanium
- Gamma Ti Aluminide
- ATI 718™ Nickel
- ATI 718Plus® Nickel
- ATI 720™ Nickel
- ATI 901™ Nickel
- ATI HX™ Nickel
- ATI Waspaloy\* Nickel
- ATI Rene™ 95 PM Nickel
- ATI A286™ Steel
- ATI FV448™ Steel
- ATI FV535™ Steel
- ATI M152™ Steel

## Combustors & Liners

- ATI 718™ Nickel
- ATI 718Plus® Nickel
- ATI HX™ Nickel
- ATI L-605™ Cobalt
- ATI 188™ Cobalt

## Shafts, Gears & Bearings

- ATI 718™ Nickel
- ATI 1014™ Steel
- ATI C-250™ Steel
- ATI HCM3™ Steel
- ATI HCM5™ Steel
- ATI RBD™ Steel

## Casings & Rings

- ATI 718™ Nickel
- ATI 718Plus® Nickel
- ATI 263™ Nickel
- ATI 625™ Nickel
- ATI GTD-222™ Nickel
- ATI HX™ Nickel
- ATI Waspaloy\* Nickel
- ATI X-750™ Nickel
- ATI A286™ Steel

© 2012 ATI. All rights reserved.  
\* Trademark of Pratt & Whitney

Version 4 - 05/11

ATI's customers in the aerospace market are focused on improving the sustainability of their products. To them, this means greater fuel efficiency, reduced emissions, quieter operations, improved reliability (reduced maintenance costs) and reduced manufacturing, fabrication, and assembly costs.

To ATI, this means using our leading technology and unsurpassed manufacturing capabilities to seize new opportunities to create customer value through new products and innovation.

## For the Aerospace Market

In the United States, the Federal Aviation Administration's Continuous Lower Emissions, Energy and Noise (CLEEN) Program has mandated a 33% reduction in aircraft fuel burn, a 32 decibel reduction in noise, and a 60% reduction in NO<sub>x</sub> emissions, relative to current aircraft by 2015. The Advisory Council for Aeronautics Research in Europe, (ACARE) has established a 50% reduction in CO<sub>2</sub> emissions, an 80% reduction in NO<sub>x</sub> emissions, and a 50% reduction in noise levels by 2020. Both CLEEN and ACARE programs are joint government – industry consortia.

Boeing has said they are committed to reducing the environmental footprint of their airplanes and they are devoting 75% of their research and development budget to improving fuel burn and noise. Airbus has publicly recognized the need for sustainable development in air travel.

For jet engines, GE Aviation has made its GEnx™ and GE90 engines for large aircraft, and CFM International LEAP-X™ engines for the new single aisle aircraft part of its "ecoimagination" product portfolio. Rolls-Royce reports that it is investing two thirds of its research and development budget to improve the environmental performance of its products. Pratt & Whitney is introducing its PurePower® Engines that offer improvements in fuel consumption, noise, environmental emissions, and operating costs.

These companies agree that the development and application of advanced materials is fundamental to achieving their sustainability objectives.

The Boeing 787 and Airbus A350XWB both use more titanium as a percentage of weight to help meet their fuel efficiency and maintenance performance objectives. The engines that power these innovative airplanes, the GEnx™ and the Rolls-Royce Trent 1000 and Trent XWB, are designed to provide improved fuel consumption, lower emissions, and reduced maintenance costs.

The trend to better performance is also moving to the new future-generation single aisle aircraft, which are designed to fly cleaner, quieter, and to be more fuel efficient than ever. These new single aisle aircraft, the Boeing 737Max, Airbus A320neo, and COMAC (Commercial Aircraft Corporation of China) C919, are in the design phase. They will use newly designed engines, such as the LEAP-X and Pratt & Whitney's PW1000G – or geared turbofan (GTF) – engine family.

The role of advanced materials in improving the fuel efficiency and reducing emissions in aero engines is related in large part to the increased efficiencies enabled by higher operating temperatures. Hotter running engines demand components capable of withstanding the harsher environment without sacrificing performance. New generations of alloys are replacing incumbent alloys to achieve the necessary performance. New nickel-based superalloys and powder metal alloys are being specified for use in the hotter sections of jet engines.

Many of these new and innovative products are already a part of ATI's product portfolio.

ATI 718Plus® Alloy is an excellent example of this trend. It is a nickel-based superalloy that is capable of operating at temperatures well in excess of standard 718 alloy, the primary superalloy used in today's jet engines. ATI 718Plus Alloy is replacing 718 alloy as well as more expensive alloys used in a variety of applications including turbine cases, disks and blades due to its combination of excellent performance with lower raw material cost. ATI 718Plus Alloy was selected by the Metals Affordability Initiative Consortium, which was formed to maintain America's technological leadership in the strategic aerospace metals market, as the best option for structural applications requiring long-term structural integrity at temperatures up to 1300 °F (704 °C).

Complex and advanced nickel-based superalloy powders are being designed into the next-generation and future-generation jet engines to meet the need for higher-strength, higher-temperature alloys. Powder metals parts are made either as near-net-shape parts or are forged into parts through the isothermal forging process. Driven by this design trend and to expand our product reach and add greater customer value to the aerospace supply chain, we purchased ATI Powder Metals in 2009 and acquired ATI Ladish in 2011. ATI Powder Metals is one of the few companies capable and qualified to produce advanced nickel-based alloy powders. ATI Ladish is a leader in isothermal forging technology and has the industry's largest isothermal forging press.

Gamma titanium aluminides are replacing lower temperature-capable nickel-based superalloys, such as 718 alloy, in the next-generation and future-generation jet engines. Gamma titanium aluminides provide significant weight savings without degradation in operating performance. Standard titanium alloys are being challenged by the increase in engine operating temperatures and being pushed toward the front (colder) section of the engine. Even in the cold section of the jet engine, design pressures are increasing and causing a shift from the most common titanium alloy, 6-4 titanium, to more complex titanium alloys such as ATI 17™ alloy, ATI 6-2-4-2™ alloy, and ATI 6-2-4-6™ alloy. Plasma Arc Melt (PAM) is the preferred melt method for these complex alloys, and ATI is the only qualified titanium producer to use PAM to produce premium-titanium alloys for jet engine rotating parts.



# INTEGRATED OIL & GAS SUPPLY CHAIN

## Maximizing Performance Through Materials & Manufacturing Know-How

ATI has also developed a unique supply chain for the Oil & Gas market. We offer an extensive array of high-strength, corrosion-resistant materials, and cutting tools necessary for the most challenging Oil & Gas exploration, drilling, production, and refining applications. An advantage of ATI is our multi-materials capabilities and our ability to provide our customers with the optimal solution to meet their corrosion and high-strength requirements.



### Melt & Remelt

Titanium products are melted and refined using PAM, EB, and VAR. Nickel-based alloys and specialty alloys use a VIM (Vacuum Induction Melt) to VAR remelt path. Some specialty alloys are melted and refined using the EAF/ESR path.



### EAF

Electric Arc Furnace is an open air melt in which scrap and alloys are melted. The process is often used in conjunction with subsequent refining.



### ESR

Electroslag Remelt is a refining process used to improve the cleanliness and structure of alloys.



### EB

Electron Beam melt is used to produce large ingots and slabs of both CP titanium and alloy titanium.



### Specialty Plate

ATI's specialty plate facility produces an unmatched array of products including titanium and titanium alloy, nickel-based and specialty alloy and duplex and stainless alloy products. It produces what we believe to be the largest and flattest CP and alloy titanium plate in the world.



### Specialty Sheet

ATI's specialty sheet facility produces an unmatched array of products including titanium and titanium alloy, nickel-based and specialty alloy and duplex and stainless alloy products.



### Radial/Rotary Forge

ATI has a variety of rotary and radial forging capabilities. Our newest such asset is a 700mm radial forge and is the largest such forge in the world for producing our specialty alloys.



### Machining & Finishing

ATI's Precision Finishing Facility in Sheffield, UK provides value-added products to the oil & gas supply chain such as nickel-based alloy rotary steerable drill shafts and specialty alloy drill collars.







Plate



Sheet



Powder Metals



Drill Bits



Seamless Tube



Downhole



Subsea



Topside



Natural Gas



Pipe Lines



Refineries



MISSION CRITICAL METALLICS



## Aerospace and Defense

### Major Products

- Nickel- and cobalt-based alloys and superalloys, titanium alloys, vacuum-melted specialty alloys for commercial and military jet engines
- Titanium alloys, vacuum-melted specialty alloys, high-strength stainless alloys, and forged and machined components for commercial and military airframe components for airframe structural parts
- Titanium investment castings for airframe and jet engine structural components
- Titanium alloy tubing and nickel-titanium shape memory alloy for aerospace hydraulic systems
- Titanium alloys and specialty alloys for fasteners
- High strength stainless alloys for composite helicopter blades
- High temperature niobium and tantalum alloys for rocket nozzles and jet engine components
- Tungsten materials for cutting tools and for counter-balance weights
- The patented high fracture toughness alloy ATI 13-8Mo SuperTough® Alloy
- ATI 500-MIL® high-hard steel, CP titanium, and ATI 6-4-MIL™ titanium plate for armor applications
- Indexable and solid carbide milling systems for aerospace metals
- Near-net-shape powder metal superalloys for commercial and military jet engines

### Major Growth Opportunities

- ATI 718Plus® alloy for jet engine applications
- ATI 425® Alloy titanium plate, sheet, foil, bar, and wire for airframe and defense applications
- ATI 17-4™ and ATI 17-7™ plate for airframe, military, and armor components
- Electron Beam (EB) single melted titanium alloy for commercial airframe applications
- Shapes for airframe applications
- Titanium sheet for airframe and jet engine applications
- Through-coolant solid carbide drill technology for drilling titanium and nickel-based alloy airframe components
- Precision threading tools for threading titanium aerospace fasteners
- Powder metal near-net-shapes

### Major Emerging Technologies

- Titanium aluminide and nickel-titanium alloys for armor and other military applications
- Patented tungsten carbide composite drills and end mills for machining airframe and engine components

## Oil & Gas/Chemical Process Industry

### Major Products

- Corrosion Resistant Alloys (CRAs) such as duplex stainless, super stainless, nickel-based, and titanium alloys for seawater environments, such as offshore oil and gas applications, and desalination projects
- Premium-melted specialty alloys and engineered products for drilling and measurement tools
- ATI's proprietary ATI Datalloy 2® non-magnetic stainless drill collars for horizontal and directional drilling in challenging unconventional environments such as shale oil and gas and oil sands deposits
- Advanced nickel and titanium alloys for completions in severe wellbore environments
- Tungsten-based materials for earth boring bits, flow regulators, metal cutting tools and high density applications for fracking
- Nickel-based superalloys, titanium alloys, and premium-melted specialty alloy products for petrochemical and refinery applications
- Titanium castings for pumps and valves
- Zirconium products for sulfuric, nitric, acetic, and formic acids and urea processing
- CP titanium, nickel-based alloys, and stainless alloys for plate frame heat exchangers
- CRAs and titanium for weld overlay and clad components such as flowline pipe
- Seamless titanium tubing for Liquefied Natural Gas heat exchangers

### Major Growth Opportunities

- ATI 2003® and ATI 2102™ lean duplex and Zeron® 100 super duplex stainless
- Powder metal near-net-shapes for wellhead oil and gas applications
- Forged and machined components

### Major Emerging Technologies

- ATI 2003® lean duplex stainless for offshore platforms and subsea flexible flowlines and risers
- Patented tungsten composite tooling for machining valve and pump components
- ATI OmegaBond® tubing for fertilizer and chemical processing
- Solid tungsten carbide bodies for diamond-based drill bits
- Nickel-based alloys for handling corrosive sour gas and petroleum reservoirs





## Electrical Energy

### Major Products

- Titanium, superferritic and duplex stainless steels, and nickel-based alloys for seawater environments
- Grain-oriented electrical steels for power distribution and power generation transformers
- Nickel-based superalloys, titanium alloys, and vacuum-melted specialty alloys for gas and steam turbine components
- Reactor-grade zirconium and hafnium products for nuclear fuel cladding and structural applications
- Tungsten carbide for centrifuge tiles, coal crushers, and fan blades
- Tungsten carbide for machining turbine blades and shafts
- Ductile iron castings for wind turbines, gas turbines, and steam turbines
- ATI Densalloy® tungsten alloys for shielding in nuclear power plants

### Major Growth Opportunities

- Oxidation resistant alloys for land-based turbines
- Corrosion and oxidation resistant alloys and bi-metallics for fuel cells
- CRAs for flue gas desulfurization pollution control equipment
- Stainless and specialty stainless alloys for solar energy applications
- Titanium alloy and CRA tubing for geothermal wells
- Tungsten heavy alloys for nuclear energy safety pumps
- Through-coolant solid carbide drill technology for drilling heat-exchanger tube sheets
- Powder metals for pumps and steam turbine components for nuclear energy plants
- ATI 690™ nickel alloy for steam generator components
- ATI NuShield™ borated stainless steel alloys for spent nuclear fuel storage and containment

### Major Emerging Technologies

- ATI 718Plus® alloy for industrial gas turbines
- Niobium-titanium, niobium alloys, and vanadium alloys for magnetic confinement of high temperature plasma in fusion reactors
- Ruthenium-based tungsten carbide for machining turbine blades

For more information on:

Aerospace and Defense, visit [ATImetals.com/aerospace](http://ATImetals.com/aerospace) and [ATImetals.com/defense](http://ATImetals.com/defense)

Oil & Gas/Chemical Process Industry, visit [ATImetals.com/oilandgas](http://ATImetals.com/oilandgas) and [ATImetals.com/chemicalprocessing](http://ATImetals.com/chemicalprocessing)

Electrical Energy, visit [ATImetals.com/nuclearenergy](http://ATImetals.com/nuclearenergy) and [ATImetals.com/electricalenergy](http://ATImetals.com/electricalenergy)

Medical, visit [ATImetals.com/medical](http://ATImetals.com/medical)

## Medical

### Major Products

- Titanium and titanium alloys, cobalt-based alloys, and zirconium-niobium alloys for surgical implants, medical equipment, and multi-component implant constructs
- Forging and machining bar stocks for total hip and total knee replacement systems
- Titanium and titanium alloy bar and rod for fracture fixation devices, pins, screws, spinal rods, and fasteners
- Titanium and titanium alloys for dental implants and cardiovascular devices
- Titanium sheet and foil for maxillofacial implant components
- Niobium-titanium alloy for superconducting magnets to power MRI imaging equipment
- Tungsten products for MRI shielding applications
- Cobalt-based alloys for spinal implants and pacemaker lead wires
- Tungsten for diagnostic isotope vial and dose shielding
- Tungsten carbide for machining medical implants
- Titanium sheet and Precision Rolled Strip® products for pacemakers and surgical implants

### Major Emerging Technologies

- Titanium alloy seamless tubing for bone nails and screws
- Boutique alloys (ATI 15Mo™ Titanium, ATI 35N LoTi™ alloys) designed to meet high fatigue strength demands for biomedical applications
- Improved biocompatible, beta titanium alloys for high-cycle fatigue structural implants
- Powder metals for complex near-net-shape components in implant constructs



## Diversified Products and Services

(Percent of ATI's 2011 Sales)

### High-Value Products

Nickel-Based Alloys and Specialty Alloys	25%
Titanium and Titanium Alloys	14%
Precision and Engineered Strip	12%
Forged and Cast Components	9%
Tungsten-Based Materials	7%
Grain-Oriented Electrical Steel	6%
Exotic Alloys	5%
<b>Total High Value</b>	<b>78%</b>

### Standard Products

Specialty Stainless Sheet	10%
Stainless Steel Sheet	9%
Stainless Steel Plate	2%
Iron Castings	1%
<b>Total Standard Products</b>	<b>22%</b>
<b>Grand Total</b>	<b>100%</b>

## Diversified Global Markets

(Percent of ATI's 2011 Sales)

Aerospace and Defense	29%
Oil and Gas/Chemical Process Industry	21%
Electrical Energy	15%
Automotive	7%
Construction and Mining	6%
Food Equipment and Appliances	5%
Medical	5%
Transportation	4%
Electronics/Communication/Computers	3%
Machine and Cutting Tools	3%
Conversion Services/Other	2%
<b>Total</b>	<b>100%</b>

## High-Value Products Sales

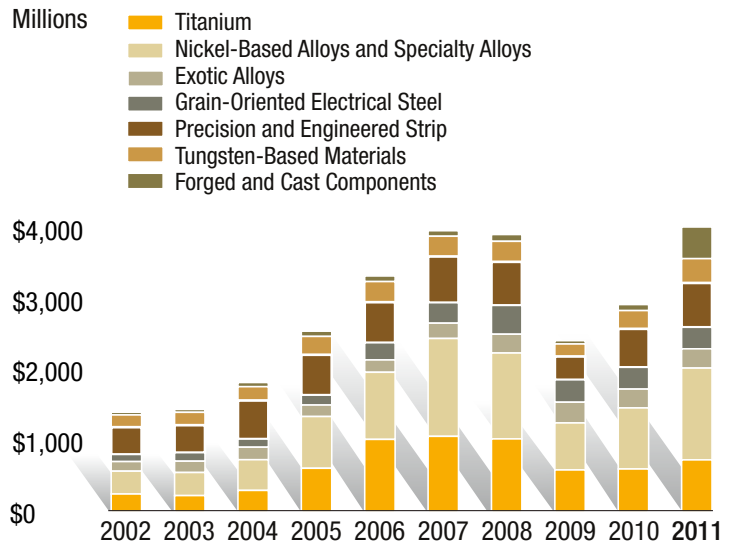

## Sales by Geographic Area

(Percent of ATI's 2011 Sales)

United States	65%
Europe	20%
Asia	10%
Canada	3%
South America, Middle East, Rest of World	2%
<b>Total</b>	<b>100%</b>

## Direct International Sales

(Percent of ATI's Total Sales)

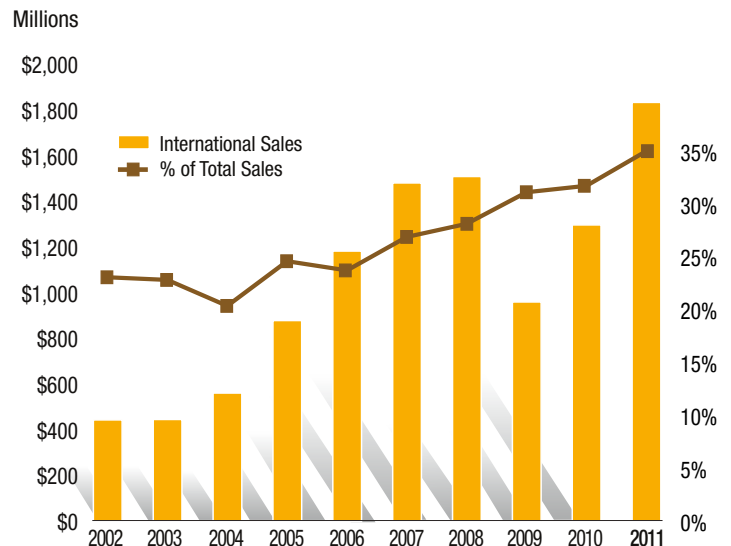

Financial Results (\$ in millions)

**High Performance Metals**

	2011	2010
Sales	\$1,955.9	\$1,337.5
Operating Profit	\$364.5	\$257.8
Percent of Sales	18.6%	19.3%
Identifiable Assets	\$3,659.8	\$2,283.2
International Sales	\$784.2	\$438.1

**Major Products**

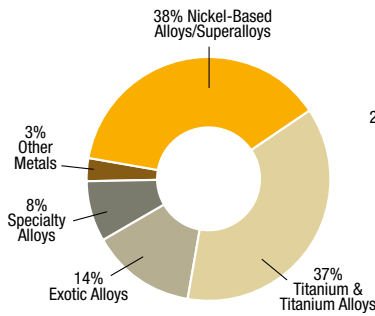

**Major Markets**

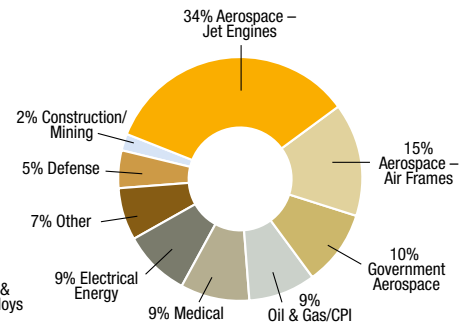

**Flat-Rolled Products**

	2011	2010
Sales	\$2,726.0	\$2,338.5
Operating Profit	\$213.4	\$85.9
Percent of Sales	7.8%	3.7%
Identifiable Assets	\$1,577.6	\$1,362.0
International Sales	\$916.2	\$758.1

**Major Products**

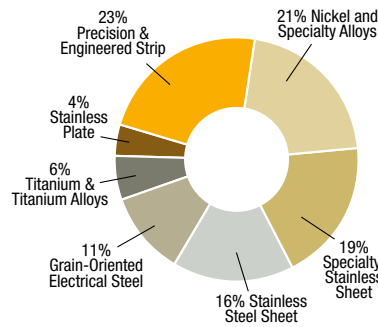

**Major Markets**

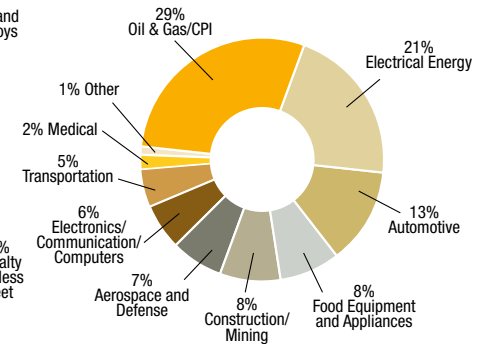

**Major Products**

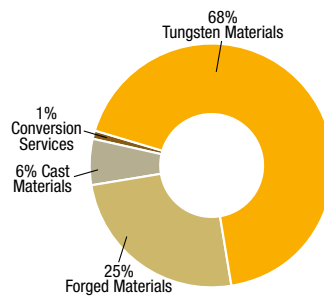

**Major Markets**

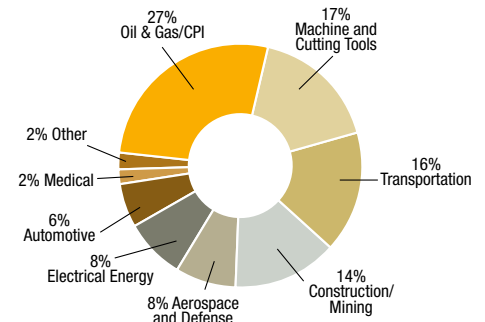

**Engineered Products**

	2011	2010
Sales	\$501.1	\$371.8
Operating Profit	\$34.1	\$12.8
Percent of Sales	6.8%	3.4%
Identifiable Assets	\$315.2	\$295.5
International Sales	\$113.7	\$87.7

**ATI Business System (ATIBS)**

A systemic and integrated business system adopted throughout ATI built on three fundamental principles: Make to Use, Elimination of Waste, and People Connect the System.

**Ammonium Paratungstate (APT)**

A purified intermediate tungsten compound made from ore or recycled tungsten scrap that is used as a starting material for making most tungsten powders.

**Annealing**

The process of heating and cooling metal in such a way as to soften it, and to produce desired changes in other properties or microstructure.

**Bar**

A long product that is 1/4 inch (6.35 mm) or more in diameter, having round, square, octagonal or hexagonal cross-sections.

**Billet**

A long product with a diameter range of 8 to 14 inches (203 to 356 mm). Can either be sold in billet form or processed further to make other long products.

**Carbide Cutting Tools**

Cemented carbides made into forms for removing materials in machining operations such as turning, milling or drilling. Normally, these tools have hard surface coatings consisting of carbides, nitrides and oxides of titanium and aluminum.

**Electric Arc Furnace (EAF)**

An open air melting furnace in which scrap and ferroalloys are melted by high electrical power carbon arcs. Refining is accomplished by slags and various gases. The process is often used in conjunction with subsequent refining processes.

**Electron Beam Furnace (EB)**

A melting furnace that uses high-energy electron beams in a vacuum environment to melt metals into a water-cooled crucible and is especially useful for titanium and exotic alloys.

**Electroslag Remelt (ESR)**

A consumable electrode remelting process in which an AC current is passed from an electrode through a molten slag pool. Molten metal droplets fall through the slag and solidify in a water-cooled copper crucible. This process is utilized to improve both the cleanliness and structure of alloys.

**Exotic Alloys**

The Company's classification for its products, which includes zirconium, niobium and hafnium.

**Flat-Rolled Products**

A product form classification that includes plate, sheet, strip and Precision Rolled Strip® products.

**Forging**

A product formed by compressive forces to plastically deform metal into a shape. ATI produces forgings as mill products and components such as titanium alloy, nickel-based and superalloy, and specialty alloy billet. ATI also produces carbon and alloy custom compression die hot forgings for applications in the transportation, construction and mining, and oil and gas markets.

**Forging Press**

A press, usually vertical, used to operate dies to deform metal plastically. May be mechanically or hydraulically operated and either closed die for shaped, part forgings or open die for cogging.

**GFM Precision Rotary Forge and Radial Forge**

A forging process where rapid simultaneous action of forging hammers subjects the workpiece to a high rate of deformation under uniform compressive stressing. The control and reproducibility of the GFM process is designed to provide optimum metallurgical consistency.

**Grain-Oriented Electrical Steel (GOES)**

Iron-based alloys containing silicon (typically 3.5%) as the major alloying addition. These steels are used generally in applications such as power distribution and power generation transformers where electrical conductivity and magnetic properties are important.

**Hafnium**

An exotic alloy usually obtained as a by-product of zirconium production with outstanding corrosion resistance and good mechanical properties. It is added to specialty alloys for use in jet engine parts and as control rod material in nuclear reactors.

**High-Performance Metals**

A classification that includes ATI's nickel-based and cobalt-based alloys and superalloys, titanium and titanium alloys, specialty alloys, and exotic alloy products, primarily in the form of long products. These products typically exhibit any of the properties of high temperature resistance, high strength, and high temperature oxidation resistance.

**High-Value Flat-Rolled Products**

A classification that includes ATI's Flat-Rolled Products segment's titanium and titanium alloys, nickel-based alloys and superalloys, specialty alloys, grain-oriented electrical steel, engineered strip and Precision Rolled Strip® products. These products typically are characterized by direct technical and service relationships with customers.

**Hot Die Forging**

A forging process in which dies are heated close to the forging temperature of the alloy being forged. Used for difficult-to-forge alloys.

**Hot Isostatic Pressing (HIP)**

A process of pressing/consolidating powder metals under the simultaneous application of temperature and pressure (equally applied in all directions) to yield 100% dense parts made of specialty metal powders, such as titanium, nickel, and stainless steel alloys.

**Ingot**

A product form resulting when molten metal is cast into molds, which can be round, square, or rectangular. Can either be sold in ingot form or processed further to make higher value mill products.

**Investment Casting**

A casting method designed to achieve high dimensional accuracy of small metal castings using a pattern which is melted out to leave a mold without joints.

**Isothermal Forging**

A hot forging process where the alloy being forged and the dies are heated to the same temperature and maintained at a constant and uniform temperature during the forging process. Process allows for nearer-net-shape forging which reduces machining.

**Long Products**

A product form classification that includes ingot, billet, bar, rod, wire and seamless tubing and custom-rolled shapes.

**Market Sector Team**

An ATI initiative whose goal is to integrate and coordinate ATI's global capabilities to offer current and new customers access to the Company's full



range of products, processes, and technical resources. Current ATI Market Sector Teams include ATI Aerospace, ATI Defense, ATI Oil and Gas, and ATI Electrical Energy.

#### **Nickel-Based Superalloys**

Nickel alloys, having nickel as the primary constituent, developed for very high temperature service where relatively high mechanical stresses are encountered and where high surface stability is frequently required. Typical applications are aircraft turbine and land-based turbine components.

#### **Niobium**

An exotic alloy valued for its strength at extremely high temperatures and its ability to superconduct, or pass electricity with minimal resistance, at very low temperatures. It is used in aerospace applications, in superconducting magnets in MRI (magnetic resonance imaging) equipment, when alloyed with titanium, and in particle accelerators.

#### **Plasma Arc Melt (PAM)**

A melting furnace that is a superior cold-hearth melting process for making alloyed premium titanium products for jet engine rotating parts, medical applications, and other critical applications.

#### **Plate**

A flat-rolled product that is 3/16 inch (4.76 mm) thick, or greater, and over 10 inches (254 mm) wide.

#### **Powder Metallurgy**

The production of specialty metals products by processes including the steps of atomizing, screening, blending, and pressing to consolidate metal powders.

#### **Precision Rolled Strip® Products**

Flat-rolled products including stainless, nickel alloys, titanium and titanium alloys, and carbon steel under 0.015 inch (0.38 mm) thick and up to 48 inches (1,219 mm) wide, as well as certain strip products with special tempers and thicknesses.

#### **Raw Materials**

Used in the production of ATI's specialty metals and include recycled scrap metal (containing iron, nickel, chromium, titanium and molybdenum), nickel, titanium sponge, zirconium sand and sponge, ferrochromium, ferrosilicon, molybdenum and its alloys, ammonium paratungstate, tungsten scrap, tungsten ore, manganese and its alloys, cobalt, niobium, and other alloying materials.

#### **Rings**

A seamless forged rolled ring with rectangular or other cross-sectional shapes up to 28 feet (8.5 m) in diameter.

#### **Rod**

A long product that is from 0.118 inch (3 mm) to 3/4 inch (19 mm) in diameter.

#### **Sheet**

A flat-rolled product that is 24 inches (610 mm) and over in width and less than 3/16 inch (4.76 mm) thick.

#### **Stainless**

A broad classification of iron-based alloys containing at least 10% chromium, known for excellent corrosion and heat resistance. Austenitic (Chrome-Nickel) grades contain 16% to 30% chromium and 4% to 20% nickel for enhanced surface quality and formability and increased corrosion and wear resistance. These grades are used in appliances, kitchen utensils, processing equipment and a variety of industrial applications. Ferritic (Chrome) grades are non-nickel-bearing and contain 11% to 17% chromium content for greater inherent strength and corrosion resistance than carbon steel. These grades are often used in automotive exhaust systems.

#### **Standard Flat-Rolled Products**

A classification that includes ATI's Flat-Rolled Products segment's stainless hot and cold rolled sheet, strip, and plate products.

#### **Strip**

A flat-rolled product 3/8 inch (9.5 mm) to under 24 inches (610 mm) wide and less than 3/16 inch (4.76 mm) thick. See also Precision Rolled Strip® Products.

#### **Super Stainless**

Stainless alloys with significant additions of chromium, nickel, molybdenum or copper. Super stainless is used in chemical processing, oil and gas, marine, heat treating, pollution and waste control industries where there are requirements for extra corrosion protection, strength or heat resistance.

#### **Superalloy**

An alloy, usually based on nickel, cobalt or iron, developed for high temperature service where relatively severe mechanical stress is encountered and where high surface stability is frequently required.

#### **Titanium**

Titanium and its alloys have very high strength-to-weight ratios. At normal temperatures, they have high resistance to corrosion. Used primarily in aerospace and defense, chemical processing industry, oil and gas, and medical markets.

#### **Titanium Sponge**

Titanium sponge is a critical raw material used to produce titanium mill products. ATI produces titanium sponge using the Kroll Process, which reduces titanium tetrachloride with magnesium. The titanium sponge with or without the addition of titanium scrap is melted into ingots or slabs.

#### **Tungsten Carbide Graded Powders**

Tungsten carbide powder, made by blending with other powder constituents like cobalt, tantalum carbide, and niobium carbide to obtain a desired composition and carbide grain size. These powders are pressed to a desired shape and then sintered in the range 1350° to 1500° Centigrade to yield a cemented carbide part.

#### **Tungsten Materials**

Include tungsten and tungsten carbide powders, sintered tungsten carbide products and cutting tools for the mining, oil and gas, and other industries requiring cutting tools with extra hardness.

#### **Vacuum Arc Remelt (VAR)**

A consumable remelting process in which a high current DC arc is maintained under vacuum between an alloy electrode and a molten metal pool contained in a water-cooled copper crucible. Sequential melting produces an ingot with good internal structure, good surface finish, and excellent chemical homogeneity.

#### **Vacuum Induction Melt (VIM)**

A melting process that uses an induction furnace inside a vacuum chamber to melt and cast nickel-based alloys, superalloys, and specialty alloys. The process is normally used for grades which require a high alloy content, precise chemistry control and low impurity levels.

#### **Wire**

A long product that is from 0.030 inch (0.76 mm) to 1/4 inch (6.35 mm) in diameter, in round, square, octagonal or hexagonal cross-sections.

#### **Zirconium**

An exotic alloy valued for its strength, high corrosion resistance, and low thermal neutron absorption. Applications include nuclear reactors, marine vessels, commercial power generation, and those requiring contact with strong acids and basic environments.

## Our Commitment to Integrity

**W**e at ATI are committed to a strong self-governance program. We have long believed that honesty and integrity are vitally important to the success of our Company. The Company's Corporate Governance Guidelines along with the charters of the Board committees provide the framework for corporate governance of ATI. These Guidelines reflect the Board's commitment to monitor the effectiveness of decision making at the Board and management levels, with a view toward achieving ATI's strategic objectives. The Corporate Governance Guidelines are available on our website, [www.ATImetals.com](http://www.ATImetals.com).

Our *Corporate Guidelines for Business Conduct and Ethics* apply to all directors, officers, employees, agents and consultants and set forth clear standards to guide the conduct of our daily affairs. Our commitment is to reflect, in each of our actions, the highest standards of ethical performance in our dealings with our Board of Directors, stockholders, fellow employees, customers, suppliers, creditors, government agencies and authorities, and the public.

Our self-governance efforts incorporate long-standing training programs that address a myriad of subjects including antitrust, ethics, environmental compliance, anti-bribery, export compliance and trading in securities, as well as training in various human resources issues, including safety.

In order to monitor the effectiveness of our compliance efforts, we perform audits throughout the organization to confirm adherence to Company policies and procedures and financial controls.

We understand that confidence in our Company is in large measure dependent upon the reliability and transparency of our financial statements, including maintaining effective internal control over financial reporting. Accordingly, our commitment to integrity in financial reporting recognizes our responsibility for providing timely information that fairly reflects our financial position and results of operations.

We encourage employees to communicate concerns before they become problems. Our corporate ombudsman and the ethics officers at our operating companies provide confidential resources for employees to surface their concerns without fear of reprisal. We have also retained the services of an independent third party supplier to operate the ATI Ethics Helpline which provides confidential, secure, and anonymous reporting capability and is available globally 24 hours a day. Building and maintaining trust, respect and communication among our employees are essential to the effectiveness of our self-governance program.

*Richard J. Harshman*  
Chairman, President and Chief Executive Officer

*Dale G. Reid*  
Executive Vice President, Finance  
and Chief Financial Officer

*Elliot S. Davis*  
Senior Vice President, General Counsel,  
Chief Compliance Officer and Corporate Secretary

UNITED STATES SECURITIES AND EXCHANGE COMMISSION

Washington, D.C. 20549

FORM 10-K

(Mark One)

[X] Annual report pursuant to Section 13 or 15(d) of the Securities Exchange Act of 1934

For the fiscal year ended December 31, 2011 OR

[ ] Transition report pursuant to Section 13 or 15(d) of the Securities Exchange Act of 1934

For the transition period from \_\_\_\_\_ to \_\_\_\_\_

Commission file number 1-12001

ALLEGHENY TECHNOLOGIES INCORPORATED

(Exact name of registrant as specified in its charter)

Delaware
(State or other jurisdiction of incorporation
or organization)

25-1792394
(I.R.S. Employer
Identification Number)

1000 Six PPG Place, Pittsburgh, Pennsylvania
(Address of principal executive offices)

15222-5479
(Zip Code)

Registrant's telephone number, including area code: (412) 394-2800

Securities registered pursuant to Section 12(b) of the Act:

Table with 2 columns: Title of each class, Name of each exchange on which registered. Row 1: Common Stock, \$0.10 Par Value, New York Stock Exchange

Securities registered pursuant to Section 12(g) of the Act: None

Indicate by check mark whether the Registrant is well known seasoned issuer, as defined in Rule 405 of the Securities Act.

Yes [X] No [ ]

Indicate by check mark if the Registrant is not required to file reports pursuant to Section 13 or Section 15(d) of the Act.

Yes [ ] No [X]

Indicate by check mark whether the Registrant (1) has filed all reports required to be filed by Section 13 or 15(d) of the Securities Exchange Act of 1934 during the preceding 12 months, and (2) has been subject to such filing requirements for the past 90 days.

Yes [X] No [ ]

Indicate by check mark whether the Registrant has submitted electronically and posted on its corporate Website, if any, every Interactive Data File required to be submitted and posted pursuant to Rule 405 of Regulation S-T (§ 232.405 of this chapter) during the preceding 12 months (or for such shorter period that the registrant was required to submit and post such files).

Yes [X] No [ ]

Indicate by check mark if disclosure of delinquent filers pursuant to Item 405 of Regulation S-K is not contained herein, and will not be contained, to the best of Registrant's knowledge, in definitive proxy or information statements incorporated by reference in Part III of this Form 10-K or any amendment to this Form 10-K. [X]

Indicate by check mark whether the registrant is a large accelerated filer, an accelerated filer, a non-accelerated filer, or a smaller reporting company. See definitions of "large accelerated filer," "accelerated filer" and "smaller reporting company" in Rule 12b-2 of the Exchange Act. (Check one):

Large accelerated filer [X] Accelerated filer [ ]
Non-accelerated filer [ ] Smaller reporting company [ ]
(Do not check if a smaller reporting company)

Indicate by check mark whether the Registrant is a shell company (as defined in Rule 12b-2 of the Exchange Act).

Yes [ ] No [X]

On February 13, 2012, the Registrant had outstanding 106,700,085 shares of its Common Stock.

The aggregate market value of the Registrant's voting stock held by non-affiliates at June 30, 2011 was approximately \$6.7 billion, based on the closing price per share of Common Stock on June 30, 2011 of \$63.47 as reported on the New York Stock Exchange. Shares of Common Stock known by the Registrant to be beneficially owned by directors and officers of the Registrant subject to the reporting and other requirements of Section 16 of the Securities Exchange Act of 1934, as amended (the "Exchange Act"), are not included in the computation. The Registrant, however, has made no determination that such persons are "affiliates" within the meaning of Rule 12b-2 under the Exchange Act.

Documents Incorporated By Reference

Selected portions of the Proxy Statement for the Annual Meeting of Stockholders to be held on May 11, 2012 are incorporated by reference into Part III of this Report.



## **INDEX**

	<b>Page Number</b>
<b>PART I</b>	
Item 1. Business	F3
Item 1A. Risk Factors	F11
Item 1B. Unresolved Staff Comments	F14
Item 2. Properties	F14
Item 3. Legal Proceedings	F15
Item 4. Mine Safety Disclosures	F15
<b>PART II</b>	
Item 5. Market for the Registrant's Common Equity, Related Stockholder Matters and Issuer Purchases of Equity Securities	F16
Item 6. Selected Financial Data	F18
Item 7. Management's Discussion and Analysis of Financial Condition and Results of Operations	F19
Item 7A. Quantitative and Qualitative Disclosures About Market Risk	F41
Item 8. Financial Statements and Supplementary Data	F43
Item 9. Changes in and Disagreements with Accountants on Accounting and Financial Disclosure	F82
Item 9A. Controls and Procedures	F82
Item 9B. Other Information	F85
<b>PART III</b>	
Item 10. Directors and Executive Officers of the Registrant	F85
Item 11. Executive Compensation	F85
Item 12. Security Ownership of Certain Beneficial Owners and Management and Related Stockholder Matters	F85
Item 13. Certain Relationships and Related Transactions, and Director Independence	F86
Item 14. Principal Accountant Fees and Services	F86
<b>PART IV</b>	
Item 15. Exhibits, Financial Statements and Financial Statement Schedules	F86
<b>SIGNATURES</b>	

## **PART I**

### **Item 1. Business**

#### **The Company**

Allegheny Technologies Incorporated (ATI) is a Delaware corporation with its principal executive offices located at 1000 Six PPG Place, Pittsburgh, Pennsylvania 15222-5479, telephone number (412) 394-2800, Internet website address <http://www.atimetals.com>. References to “Allegheny Technologies,” “ATI,” the “Company,” the “Registrant,” “we,” “our” and “us” and similar terms mean Allegheny Technologies Incorporated and its subsidiaries, unless the context otherwise requires.

#### **Our Business**

Allegheny Technologies is one of the largest and most diversified specialty metals producers in the world. We use innovative technologies to offer growing global markets a wide range of specialty metals solutions. Our products include titanium and titanium alloys, nickel-based alloys and superalloys, zirconium, hafnium and niobium, advanced powder alloys, stainless and specialty steel alloys, grain-oriented electrical steel, tungsten-based materials and cutting tools, carbon alloy impression die forgings, and large grey and ductile iron castings. Our specialty metals are produced in a wide range of alloys and product forms and are selected for use in applications that demand metals having exceptional hardness, toughness, strength, resistance to heat, corrosion or abrasion, or a combination of these characteristics. The acquisition of Ladish Co., Inc. (now ATI Ladish) on May 9, 2011 added advanced forgings, titanium investment castings and precision finishing capabilities to ATI’s product portfolio. Results for ATI Ladish, which principally serves the aerospace & defense market, are included in the High Performance Metals segment from the acquisition date. ATI is a fully integrated supplier from raw material (for titanium) and melt (for other specialty alloy systems) through highly engineered finished components.

We focus our advanced specialty metals technology, unsurpassed manufacturing capabilities, and innovative products to serve global end use markets with highly diversified and specialized product offerings. Strategic end use markets for our products include:

***Aerospace and Defense.*** We are a world leader in the production of premium titanium alloys, nickel-based and cobalt-based alloys and superalloys, and vacuum-melted specialty alloys used in the manufacture of components for both commercial and military jet engines, as well as replacement parts for those engines. We also produce titanium alloys, vacuum-melted specialty alloys, and high-strength stainless alloys for use in commercial and military airframes, airframe components and missiles. ATI produces unique titanium and high-hard steel alloys as well as engineered parts and castings for the current and next-generation armored vehicles.

Titanium and titanium alloys are critical metals in aerospace and defense applications. Titanium and titanium alloys possess an extraordinary combination of properties, including superior strength-to-weight ratio, good elevated temperature resistance, low coefficient of thermal expansion, and extreme corrosion resistance. These metals are used to produce jet engine components such as blades, vanes, discs, and casings, and airframe components such as structural members, landing gear, hydraulic systems, and fasteners. The latest and next-generation airframes and jet engines use even more titanium and titanium alloys in component parts in order to minimize weight and maximize fuel efficiency.

Our nickel-based alloys and superalloys and specialty alloys are also widely used in aerospace and defense applications. Nickel-based alloys and superalloys remain extremely strong at high temperatures and resist degradation under extreme conditions. Typical aerospace applications for nickel-based alloys and superalloys include jet engine shafts, discs, blades, vanes, rings and casings.

Our specialty alloys include vacuum-melted maraging steels used in the manufacture of aircraft landing gear and structural components, as well as jet engine components.

Our titanium alloy, nickel-based alloy, and specialty alloy precision forgings and titanium investment castings are used in aerospace jet engine and airframe applications.

ATI also offers tungsten cutting tools and machining for difficult-to-machine specialty metals, such as titanium alloys, nickel-based superalloys, and specialty alloys used in airframe, jet engine, and armor applications.

We continuously seek to develop innovative new alloys to better serve the needs of this end use market. For example, we developed ATI 718 Plus® alloy, a new nickel-based superalloy that can withstand higher temperatures than the standard 718 superalloy, for use in legacy jet engines and the next generation of fuel efficient jet engines. We also developed ATI 425® alloy sheet, a new cold-rollable titanium alloy, that is an alternative to the most popular high-strength titanium alloys, for use in airframe components. ATI 425® - MIL titanium is an innovative new armor alloy that has the advantage of superior formability as compared to conventional high-strength titanium alloys.

Demand for our products by the aerospace and defense market has increased significantly over the last several years. Based on current forecasts and existing backlogs reported by the two manufacturers of large commercial aircraft, we expect to benefit from increased production schedules for legacy and next-generation aircraft, and increased demand for aftermarket jet engine spare parts.

**Oil and Gas and Chemical Process Industry.** The environments in which oil and gas can be found in commercial quantities have become more challenging, involving deep offshore wells, high pressure and temperature conditions, sour wells and unconventional sources, such as oil and gas shale, liquid natural gas, oil sands, and enhanced oil recovery of existing fields. Challenging offshore environments are in remote locations that are further off the continental shelf, including arctic and tropic locations, often one mile or more below the water's surface. The requirements for equipment, which could operate for up to 30 years in these environments, require the specialty metals that we produce.

All of our business segments produce specialty metals that are critical to the oil and gas industry and the chemical process industry. Our specialty metals, including titanium and titanium alloys, nickel-based alloys, zirconium alloys, stainless and duplex alloys and other specialty alloys, have the strength and corrosion resistant properties necessary for difficult environments. Global demand for these materials is increasing, particularly in growing markets in Asia, the Middle East, North Africa and South America. Demand for these products in North America is growing due to increased activity in oil and gas shale reserves.

We have developed a family of duplex alloys, including ATI 2003®, ATI 2102™, and ATI 2304™ lean duplex alloys, for use in deep-water oil and gas applications. Several of our strip, plate and cast products are NORSOK qualified. The NORSOK standards are developed by the Norwegian petroleum industry and are intended to identify metals used in oil and gas applications that are safe and cost-effective. Our Datalloy2® non-magnetic stainless is used for drill collars that enable the most advanced directional and horizontal drilling techniques to be guided to the exact position desired for the reservoir.

Tungsten is the most dense and heat resistant metal commercially available. One application for our tungsten products is in oil and gas drill bit inserts and bodies. As drilling methods such as directional and horizontal drilling become more complex, our advanced tungsten carbide materials are often specified in order to enable faster drilling and longer drill bit life.

**Electrical Energy.** Our specialty metals are widely used in the global electric power generation and distribution industry. We believe that U.S. and European energy needs and environmental policies and the electrification of developing countries will continue to drive demand for our specialty metals products that we sell for use in this industry.

For electrical power generation, our specialty metals, corrosion resistant alloys (CRAs) and ductile iron castings are used in coal, nuclear, natural gas, and wind power applications. In coal-fired plants, our CRAs are used for pipe, tube, and heat exchanger applications in water systems in addition to pollution control scrubbers. Our CRAs are also used in water systems for nuclear power plants. For nuclear power plants, we are an industry pioneer in producing reactor-grade zirconium and hafnium alloys used in nuclear fuel cladding and structural components. We are a technology leader for large diameter nickel-based superalloys used in natural gas land-based turbines for power generation. For renewable energy generation, our alloys are used for solar and geothermal applications. We are also one of a few U.S. producers of very large ductile iron castings used for wind turbines.

ATI is a premier supplier of certified nuclear-grade alloys and specialty alloys for applications that range from the reactor core to steam water systems to spent-fuel storage, transportation and repository activities. ATI has been a part of the nuclear energy market since the first commercial nuclear energy reactor was built in the United States. We have expanded our production capabilities and capacity to support expected growth of the nuclear energy market. We have developed Nushield™ products, a new line of borated stainless alloys that begin with our advanced powder metals and are used for spent nuclear fuel applications.

For electrical power distribution, our grain-oriented electrical steel (GOES) is used in large and small power transformers, where electrical conductivity and magnetic properties are important. In January 2010, the U.S. Department of Energy (DOE) began requiring more efficient transformers, which increases premium grade GOES usage per transformer. ATI is a leading producer of these premium grades of GOES. In February 2011, the U.S. DOE proposed a rule that would further raise transformer efficiency standards effective January 2016. This new rule calls for the continued use of GOES in large and small power distribution transformers.

**Medical.** ATI's advanced specialty metals are used in medical device products that save and enhance the quality of lives.

Our zirconium-niobium, titanium-and cobalt-based alloys are used for knees, hips and other prosthetic devices. These replacement devices offer the potential of lasting much longer than previous implant options.

Our biocompatible nickel-titanium shape memory alloy is used for stents to support collapsed or clogged blood vessels. Reduced in diameter for insertion, these stents expand to the original tube-like shape due to the metal's superelasticity. Our ultra fine diameter (0.002 inch/0.051 mm) titanium wire is used for screens to prevent blood clots from entering critical areas of the body. In addition, our titanium bar and wire are used to make surgical screws for bone repairs.



Manufacturers of magnetic resonance imaging (MRI) devices rely on our niobium superconducting wire to help produce electromagnetic fields that allow physicians to safely scan the body's soft tissue. In addition, our tungsten heavy alloy materials are used for shielding applications in MRI devices.

**Enhancing and Expanding Our Manufacturing Capabilities and Capacity.** Demand for our products from the aerospace and defense, oil and gas, chemical process industry, electrical energy, and medical markets increased significantly over the last several years. We have been undertaking a multi-phase program to enhance and expand our capabilities and capacities to produce premium specialty metals aimed at these strategic markets. Over the last eight years we have invested approximately \$3.3 billion of internally generated funds to renew and expand our annual titanium sponge production capabilities to approximately 46 million pounds; expand our premium titanium alloy melt and remelt capacity; expand our nickel-based alloy and superalloy melt and remelt capacity; expand our titanium and specialty alloy plate capacity; expand our premium titanium and nickel-based superalloy forging capacity; and double our annual reactor-grade zirconium sponge capacity to 8 million pounds. We believe these investments strengthen and enhance ATI's leadership position in the production of advanced specialty metals.

### ***Business Segments***

We operate in the following three business segments, which accounted for the following percentages of total revenues of \$5.18 billion, \$4.05 billion, and \$3.05 billion for the years ended December 31, 2011, 2010, and 2009, respectively:

	<b>2011</b>	2010	2009
High Performance Metals	<b>38%</b>	33%	42%
Flat-Rolled Products	<b>52%</b>	58%	50%
Engineered Products	<b>10%</b>	9%	8%

Information with respect to our business segments is presented below and in Note 14 of the Notes to the Consolidated Financial Statements.

### ***High Performance Metals Segment***

Our High Performance Metals segment produces, converts and distributes a wide range of high performance alloys, including nickel- and cobalt-based alloys and superalloys, titanium and titanium-based alloys, exotic metals such as zirconium, hafnium, niobium, nickel-titanium, and their related alloys, and other specialty alloys, primarily in long product forms such as ingot, billet, bar, shapes and rectangles, rod, wire, seamless tube, and castings. We also produce nickel-based alloys and superalloys, titanium alloys, and specialty metal powders, and semi-finished near-net-shape products from these advanced powder alloys. Through the acquisition of ATI Ladish, we produce precision forgings, castings and machined parts. We are integrated from raw materials (sponge) to melt, remelt, finish processing, forging, investment casting, and machining in our titanium and titanium alloys, and zirconium and hafnium alloys products. The major end markets served by our High Performance Metals segment are aerospace and defense, oil and gas, chemical process industry, electrical energy, and medical. Most of the products in our High Performance Metals segment are sold directly to end-use customers. A significant portion of our High Performance Metals segment products are sold under multi-year agreements. The operating units in this segment are ATI Allvac, ATI Allvac Ltd (U.K.), ATI Ladish, ATI Wah Chang, and ATI Powder Metals.

Approximately 64% of High Performance Metals segment revenue is derived from the aerospace and defense market. Demand for our products is driven primarily by the commercial aerospace cycle. Large aircraft and aircraft engines are manufactured by a small number of companies, such as The Boeing Company, Airbus S.A.S. (an EADS company), Bombardier Aerospace (a division of Bombardier Inc.), and Embraer (Empresa Brasileira de Aeronáutica S.A.) for airframes, and GE – Aviation (a division of General Electric Company), Rolls-Royce plc, Pratt & Whitney (a division of United Technologies Corporation), Snecma (SAFRAN Group), and various joint ventures that manufacture jet engines. These companies and their suppliers form a substantial part of our customer base in this business segment. ATI supplies the aerospace and defense supply chain with nickel- and cobalt-based alloys and superalloys, titanium alloys, vacuum-melted specialty alloys, and advanced powder alloys for commercial and military jet engines, for both original engines and spare parts. For commercial and military airframe and structural parts, ATI manufactures titanium alloys, vacuum-melted specialty alloys, and high-strength stainless alloys. The loss of one or more of our customers in the aerospace and defense market could have a material adverse effect on ATI's results of operations and financial condition.

### ***Flat-Rolled Products Segment***

Our Flat-Rolled Products segment produces, converts and distributes stainless steel, nickel-based alloys and superalloys, titanium and titanium-based alloys and specialty alloys in a variety of product forms, including plate, sheet, engineered strip, and Precision Rolled Strip® products, as well as grain-oriented electrical steel sheet. The major end markets for our flat-rolled products are oil and gas, chemical process industry, electrical energy, automotive, food equipment and appliances, construction and mining, aerospace and

defense, and electronics, communication equipment and computers. The operations in this segment are ATI Allegheny Ludlum, the Chinese joint venture company known as Shanghai STAL Precision Stainless Steel Company Limited (STAL), in which we hold a 60% interest, and our 50% interest in the industrial titanium joint venture known as Uniti LLC. The remaining 40% interest in STAL is owned by the Baosteel Group, a state authorized investment company whose equity securities are publicly traded in the People's Republic of China. The remaining 50% interest in Uniti LLC is held by Verkhnyaya Salda Metallurgical Production Association (VSMPO), a Russian producer of titanium, aluminum, and specialty steel products.

Stainless steel, nickel-based alloys and titanium sheet products are used in a wide variety of industrial and consumer applications. In 2011, approximately 50% by volume of our stainless sheet products were sold to independent service centers, which have slitting, cutting or other processing facilities, with the remainder sold directly to end-use customers.

Engineered strip and very thin Precision Rolled Strip® products are used by customers to fabricate a variety of products primarily in the automotive, construction, and electronics markets. In 2011, approximately 90% by volume of our engineered strip and Precision Rolled Strip products were sold directly to end-use customers or through our own distribution network, with the remainder sold to independent service centers.

Stainless steel, nickel-based alloy and titanium plate products are primarily used in industrial markets. In 2011, approximately 50% by volume of our plate products were sold to independent service centers, with the remainder sold directly to end-use customers.

Grain-oriented electrical steel is used in power transformers where electrical conductivity and magnetic properties are important. Nearly all of our grain-oriented electrical steel products are sold directly to end-use customers.

### ***Engineered Products Segment***

The principal business of our Engineered Products segment includes the production of tungsten powder, tungsten heavy alloys, tungsten carbide materials, and tungsten carbide cutting tools. We are integrated from the raw materials (ammonium paratungstate (APT)) to the manufacture of our tungsten-based products. The segment also produces carbon alloy steel impression die forgings, and large grey and ductile iron castings, and provides precision metals processing services. The operating units in this segment are ATI Tungsten Materials, ATI Portland Forge, ATI Casting Service and ATI Precision Finishing.

We produce a line of sintered tungsten carbide products that approach diamond hardness for industrial markets including automotive, oil and gas, chemical process industry, machine and cutting tools, aerospace, construction and mining, and other markets requiring tools with extra hardness. Technical developments related to ceramics, coatings and other disciplines are incorporated in these products. We also produce tungsten and tungsten carbide powders.

We forge carbon alloy steels into finished forms that are used primarily in the transportation and construction equipment markets. We also cast grey and ductile iron metals used in the transportation, wind power generation and automotive markets. We have precision metals processing capabilities that enable us to provide process services for most high-value metals from ingots to finished product forms. Such services include grinding, polishing, blasting, cutting, flattening, and ultrasonic testing.

### **Competition**

Markets for our products and services in each of our three business segments are highly competitive. We compete with many producers and distributors who, depending on the product involved, range from large diversified enterprises to smaller companies specializing in particular products. Factors that affect our competitive position are the quality of our products, services and delivery capabilities, our capabilities to produce a wide range of specialty materials in various alloys and product forms, our technological capabilities including our research and development efforts, our marketing strategies, the prices for our products and services, our manufacturing costs, and industry manufacturing capacity.

We face competition from both domestic and foreign companies. Some of our foreign competitors are either directly or indirectly government subsidized. In 1999, the United States imposed antidumping and countervailing duties on dumped and subsidized imports of stainless steel sheet and strip in coils and stainless steel plate in coils from companies in ten foreign countries. The antidumping and countervailing duty orders were reviewed in 2011 by the U.S. Department of Commerce and the U.S. International Trade Commission to determine whether the orders should remain in place for another five years. The agencies decided that nine such orders against five countries will continue in effect. We continue to monitor unfairly traded imports from foreign producers for appropriate action.

## ***Major Competitors***

### ***Nickel-based alloys and superalloys and specialty steel alloys***

- Carpenter Technology Corporation: A
- Special Metals Corporation, a Precision Castparts Corp. company: C
- Haynes International, Inc.: B
- Inoxum (part of ThyssenKrupp AG) (Germany): C

### ***Titanium and titanium-based alloys***

- Titanium Metals Corporation: C
- RMI Titanium, an RTI International Metals Company: C
- VSMPO - AVISMA (Russia): A

### ***Precision forgings and titanium investment castings***

- Precision Castparts Corp.: A
- Firth Rixson Limited (United Kingdom): A
- Aubert & Duval, a group member of Eramet (France): A

### ***Exotic alloys***

- Cezus, a group member of AREVA (France): A
- HC Stark: A
- Western Zirconium Plant of Westinghouse Electric Company, owned by Toshiba Corporation: A

### ***Stainless steel***

- AK Steel Corporation: B
- North American Stainless (NAS), owned by Acerinox S.A. (Spain): B
- Inoxum (part of ThyssenKrupp AG) USA: B
- Outokumpu Stainless Plate Products, owned by Outokumpu Oyj (Finland): B
- Imports from
  - Aperam (formerly part of Arcelor Mittal) (France, Belgium and Germany): B
  - Inoxum (part of ThyssenKrupp AG (Germany) including Mexinox S.A. de C.V., group member (Mexico)): B
  - Ta Chen International Corporation (Taiwan): B
  - Various Chinese producers: B

### ***Tungsten and tungsten carbide products***

- Kennametal Inc.: D
- Iscar (Israel): D
- Sandvik AB (Sweden): D
- Seco Tools AB (Sweden), owned by Sandvik AB: D

KEY – A = Primarily High Performance Metals segment, B = Primarily Flat-Rolled Products segment, C = Both High Performance Metals and Flat-Rolled Products segments, D = Primarily Engineered Products segment

## **Raw Materials and Supplies**

Substantially all raw materials and supplies required in the manufacture of our products are available from more than one supplier and the sources and availability of raw materials essential to our businesses are currently adequate. The principal raw materials we use in the production of our specialty metals are scrap (including iron-, nickel-, chromium-, titanium-, molybdenum-, and tungsten-bearing scrap), nickel, titanium sponge, zirconium sand and sponge, ferrochromium, ferrosilicon, molybdenum and molybdenum alloys, manganese and manganese alloys, cobalt, niobium, vanadium and other alloying materials.

Purchase prices of certain principal raw materials have been volatile. As a result, our operating results may be subject to significant fluctuation. We use raw materials surcharge and index mechanisms to offset the impact of increased raw material costs; however, competitive factors in the marketplace may limit our ability to institute such mechanisms, and there can be a delay between the increase in the price of raw materials and the realization of the benefit of such mechanisms. For example, in 2011 we used approximately 95 million pounds of nickel; therefore a hypothetical increase of \$1.00 per pound in nickel prices would result in increased costs of approximately \$95 million. We also used approximately 810 million pounds of ferrous scrap in the production of our flat-rolled products in 2011, so that a hypothetical increase of \$0.01 per pound in ferrous scrap prices would result in increased costs of approximately \$8 million.



While we are increasing our manufacturing capacity to produce titanium sponge, the major raw material for our titanium products, a portion of our needs, together with certain other raw materials, such as nickel, cobalt, and ferrochromium, are available to us and our specialty metals industry competitors primarily from foreign sources. Some of these foreign sources are located in countries that may be subject to unstable political and economic conditions, which could disrupt supplies or affect the price of these materials.

We purchase our nickel requirements principally from producers in Australia, Canada, Norway, Russia, and the Dominican Republic. Zirconium raw materials are primarily purchased from the U.S. and China. Cobalt is purchased primarily from producers in Canada. More than 80% of the world's reserves of ferrochromium are located in South Africa, Zimbabwe, Albania, and Kazakhstan. We also purchase titanium sponge from sources in Kazakhstan and Japan.

### Export Sales and Foreign Operations

Direct international sales represented approximately 35% of our total annual sales in 2011, 32% of our total sales in 2010, and 31% of our total sales in 2009. These figures include direct export sales by our U.S.-based operations to customers in foreign countries, which accounted for approximately 26% of our total sales in 2011, 23% of our total sales in 2010, and 22% of our total sales in 2009. Our overseas sales, marketing and distribution efforts are aided by our international marketing and distribution offices, ATI Europe, ATI Europe Distribution, and ATI Asia, or by independent representatives located at various locations throughout the world. We believe that at least 50% of ATI's 2011 sales were driven by global markets when we consider exports of our customers. Direct sales by geographic area in 2011, and as a percentage of total sales, were as follows:

*(In millions)*

United States	\$ 3,368.9	65%
Europe	1,048.9	20%
Far East	512.6	10%
Canada	131.8	3%
South America, Middle East and other	120.8	2%
Total sales	\$ 5,183.0	100%

ATI Allvac Ltd has manufacturing capabilities for melting, remelting, forging and finishing nickel-based alloys and specialty alloys in the United Kingdom. ATI Tungsten Materials, which has manufacturing capabilities in the United Kingdom and Switzerland, sells high precision threading, milling, boring and drilling components, tungsten carbide burrs, rotary tooling and specialty abrasive wheels and discs for the European market from locations in the United Kingdom, Switzerland, Germany, France, and Italy. ATI Ladish has manufacturing capabilities for precision forging and machining in Poland, primarily serving the construction, transportation and aerospace markets. Our STAL joint venture in the People's Republic of China produces Precision Rolled Strip products, which enables us to offer these products more effectively to markets in China and other Asian countries. Our Uniti LLC joint venture allows us to offer titanium products to industrial markets more effectively worldwide.

### Backlog, Seasonality and Cyclicity

Our backlog of confirmed orders was approximately \$2.1 billion at December 31, 2011 and \$1.5 billion at December 31, 2010. We expect that approximately 82% of confirmed orders on hand at December 31, 2011 will be filled during the year ending December 31, 2012. Backlog of confirmed orders of our High Performance Metals segment was approximately \$1.5 billion at December 31, 2011 and \$0.7 billion at December 31, 2010. We expect that approximately 85% of the confirmed orders on hand at December 31, 2011 for this segment will be filled during the year ending December 31, 2012. Backlog of confirmed orders of our Flat-Rolled Products segment was approximately \$0.5 billion at December 31, 2011 and \$0.7 billion at December 31, 2010. We expect that 70% of the confirmed orders on hand at December 31, 2011 for this segment will be filled during the year ending December 31, 2012.

Generally, our sales and operations are not seasonal. However, demand for our products is cyclical over longer periods because specialty metals customers operate in cyclical industries and are subject to changes in general economic conditions and other factors both external and internal to those industries.

### Research, Development and Technical Services

We believe that our research and development capabilities give ATI an advantage in developing new products and manufacturing processes that contribute to the profitable growth potential of our businesses on a long-term basis. We conduct research and development at our various operating locations both for our own account and, on a limited basis, for customers on a contract basis. Research and development expenditures for each of our three segments for the years ended December 31, 2011, 2010, and 2009 included the following:

<i>(In millions)</i>	2011	2010	2009
<b>Company-Funded:</b>			
High Performance Metals	\$ 10.8	\$ 11.9	\$ 14.5
Flat-Rolled Products	6.2	1.9	1.8
Engineered Products	2.3	2.7	3.0
	<b>\$ 19.3</b>	<b>\$ 16.5</b>	<b>\$ 19.3</b>
<b>Customer-Funded:</b>			
High Performance Metals	\$ 1.5	\$ 0.8	\$ 0.3
<b>Total Research and Development</b>	<b>\$ 20.8</b>	<b>\$ 17.3</b>	<b>\$ 19.6</b>

Our research, development and technical service activities are closely interrelated and are directed toward cost reduction and process improvement, process control, quality assurance and control, system development, the development of new manufacturing methods, the improvement of existing manufacturing methods, the improvement of existing products, and the development of new products.

We own hundreds of United States patents, many of which are also filed under the patent laws of other nations. Although these patents, as well as our numerous trademarks, technical information, license agreements, and other intellectual property, have been and are expected to be of value, we believe that the loss of any single such item or technically related group of such items would not materially affect the conduct of our business.

### **Environmental, Health and Safety Matters**

We are subject to various domestic and international environmental laws and regulations that govern the discharge of pollutants, and disposal of wastes, and which may require that we investigate and remediate the effects of the release or disposal of materials at sites associated with past and present operations. We could incur substantial cleanup costs, fines, civil or criminal sanctions, third party property damage or personal injury claims as a result of violations or liabilities under these laws or non-compliance with environmental permits required at our facilities. We are currently involved in the investigation and remediation of a number of our current and former sites as well as third party sites.

We consider environmental compliance to be an integral part of our operations. We have a comprehensive environmental management and reporting program that focuses on compliance with all federal, state, regional and local environmental laws and regulations. Each operating company has an environmental management system that includes mechanisms for regularly evaluating environmental compliance and managing changes in business operations while assessing environmental impact.

Our *Corporate Guidelines for Business Conduct and Ethics* address compliance with environmental laws as well as employment and workplace safety laws, and also describe our commitment to equal opportunity and fair treatment of employees. We continued to realize significant progress in safety across ATI's operations during 2011. As a result of our continuing focus on and commitment to safety, in 2011 our OSHA Total Recordable Incident Rate was 2.61 and our Lost Time Case Rate was 0.47, which we believe to be competitive with world class performance.

### **Employees**

We have approximately 11,400 full-time employees, of which approximately 15% are located outside the United States. Approximately 47% of our workforce is covered by various collective bargaining agreements, principally with the United Steel, Paper and Forestry, Rubber, Manufacturing, Energy, Allied Industrial and Service Workers International Union ("USW"). During 2011, we finalized new collective bargaining agreements with USW-represented production, office and maintenance employees at our Allegheny Ludlum operations in the Flat-Rolled Products segment that extend through June 30, 2015. We also finalized new six-year collective bargaining agreements for represented employees at ATI Ladish Forging, which will take effect as the current agreement with each bargaining unit expires, and extend to either 2018 or 2019, as applicable. There are no significant collective bargaining agreements that expire in 2012.

### **Available Information**

Our Internet website address is <http://www.atimetals.com>. Our annual reports on Form 10-K, quarterly reports on Form 10-Q, current reports on Form 8-K and amendments to those reports filed or furnished pursuant to Section 13(a) or 15(d) of the Securities Exchange Act of 1934, as well as proxy and information statements and other information that we file, are available free of charge through our Internet website as soon as reasonably practicable after we electronically file such material with, or furnish such material to, the United States Securities and Exchange Commission ("SEC"). Our Internet website and the content contained therein or connected thereto are not intended to be incorporated into this Annual Report on Form 10-K. You may read and copy materials we file with the

SEC at the SEC's Public Reference Room at 100 F Street, NE, Washington, DC 20549. You may obtain information on the operation of the Public Reference Room by calling the SEC at 1-800-SEC-0330. The SEC maintains an Internet website at <http://www.sec.gov>, which contains reports, proxy and information statements and other information that we file electronically with the SEC.

### Executive Management, Including Executive Officers under Federal Securities Laws

The following are members of the Company's executive management, including executive officers under the federal securities laws, as of February 13, 2012:

Name	Age	Title
Richard J. Harshman*	55	Chairman, President and Chief Executive Officer
Dale G. Reid*	56	Executive Vice President, Finance and Chief Financial Officer
Hunter R. Dalton*	57	Executive Vice President, Long Products and President, ATI Allvac
Terry L. Dunlap*	52	Executive Vice President, Flat-Rolled Products and President, ATI Allegheny Ludlum
David M. Hogan*	65	Executive Vice President, Engineered Products Segment
John D. Sims	52	Executive Vice President, Primary Metals and Exotic Alloys and President, ATI Wah Chang
Gary J. Vroman	52	Executive Vice President, High Performance Forgings and Castings
Elliot S. Davis*	50	Senior Vice President, General Counsel, Chief Compliance Officer and Corporate Secretary
Carl R. Moulton	64	Senior Vice President, International
Karl D. Schwartz*	48	Controller and Chief Accounting Officer

\* Such individuals are subject to the reporting and other requirements of Section 16 of the Securities Exchange Act of 1934, as amended.

Set forth below are descriptions of the business background for the past five years of the Company's executive officers and management.

*Richard J. Harshman* became Chairman, President and Chief Executive Officer on May 1, 2011. Mr. Harshman was President and Chief Operating Officer from August 2010 to May 2011. Prior to that, he served as Executive Vice President, Finance and Chief Financial Officer from October 2003 to August 2010. Mr. Harshman was Senior Vice President, Finance from December 2001 to October 2003 and Vice President, Finance from December 2000 to December 2001. Prior to that, he was Vice President, Investor Relations and Corporate Communications. Previously, he had served in a number of financial management roles for Allegheny Technologies Incorporated and Teledyne, Inc.

*Dale G. Reid* was named Executive Vice President, Finance and Chief Financial Officer on May 1, 2011. Previously, Mr. Reid served as Senior Vice President, Finance and Principal Financial Officer from August 2010 until May 2011. Mr. Reid is responsible for ATI's strategic sourcing and information technologies shared services and the world-wide accounting, treasury, tax, and internal audit functions. Mr. Reid also chairs the corporate pension investment committee. Previously, he served as Vice President, Controller, Chief Accounting Officer, and Treasurer from December 2003 to August 2010.

*Hunter R. Dalton* became Executive Vice President, Long Products on May 1, 2011. He has served as President, ATI Allvac since April 2008. Previously, he served as Group President, ATI Long Products from October 2008 to May 2011. From November 2003 to April 2008, Mr. Dalton served as Senior Vice President of Sales and Marketing for ATI Allvac.

*Terry L. Dunlap* became Executive Vice President, Flat-Rolled Products on May 1, 2011. He has served as President, ATI Allegheny Ludlum since November 2002. Previously, he served as Group President, ATI Flat-Rolled Products from October 2008 to May 2011.

*David M. Hogan* became Executive Vice President, Engineered Products Segment on May 1, 2011. Previously, he served as Group President, Engineered Products from April 2007 to May 2011. Mr. Hogan also served as President of ATI Tungsten Materials from 1997 to June 2010.

*John D. Sims* became Executive Vice President, Primary Metals and Exotic Alloys on May 1, 2011. He has served as President, ATI Wah Chang since October 2008. Previously, Mr. Sims was Group President, ATI Primary Metals and Exotic Alloys beginning from February 2011 to May 2011. Mr. Sims advanced through a variety of positions with technical and operational responsibility since joining the Company in 1996.



*Gary J. Vroman* became Executive Vice President, High Performance Forgings and Castings in June 2011. Mr. Vroman has served as President, ATI Ladish since May 2011, upon ATI's completion of the Ladish acquisition. Previously, Mr. Vroman was the President and Chief Executive Officer of Ladish Co., Inc.

*Elliot S. Davis* became Senior Vice President, General Counsel, Chief Compliance Officer and Corporate Secretary on May 1, 2011. Previously, Mr. Davis was Vice President and General Counsel beginning from August 2010 to May 2011. Previously, he served as Assistant General Counsel since 2008 when he joined the Company. Mr. Davis had previously been a partner of K&L Gates LLP, where he practiced for nearly 20 years in their corporate, mergers and acquisitions and securities group.

*Carl R. Moulton* was named Senior Vice President, International on May 1, 2011. Previously, Mr. Moulton served as Vice President, International since March 2009. Prior to that, Mr. Moulton was President of Uniti LLC since its formation in 2003.

*Karl D. Schwartz* is Controller and Chief Accounting Officer in and has served in that role since May 2011. Previously, Mr. Schwartz served as Controller and Principal Accounting Officer since August 2010. Prior to that, Mr. Schwartz had served as Assistant Controller since April 2002, when he joined the Company.

## **Item 1A. Risk Factors**

There are inherent risks and uncertainties associated with our business that could adversely affect our operating performance and financial condition. Set forth below are descriptions of those risks and uncertainties that we currently believe to be material, but the risks and uncertainties described are not the only risks and uncertainties that could affect our business. See the discussion under "Forward-Looking Statements" in Item 7. Management's Discussion and Analysis of Financial Condition and Results of Operations, in this Annual Report on Form 10-K.

### Risks Associated With Our Business

***Cyclical Demand for Products.*** The cyclical nature of the industries in which our customers operate causes demand for our products to be cyclical, creating potential uncertainty regarding future profitability. Various changes in general economic conditions may affect the industries in which our customers operate. These changes could include decreases in the rate of consumption or use of our customers' products due to economic downturns. Other factors that may cause fluctuation in our customers' positions are changes in market demand, lower overall pricing due to domestic and international overcapacity, currency fluctuations, lower priced imports and increases in use or decreases in prices of substitute materials. As a result of these factors, our profitability has been and may in the future be subject to significant fluctuation.

Worldwide economic conditions deteriorated significantly in the recent past and could remain weak in the future. These conditions have had, and may continue to have, an adverse effect on demand for our customers' products and, in turn, on demand for our products. If these conditions persist or worsen, our results of operations and financial condition could be materially adversely affected.

***Product Pricing.*** From time-to-time, reduced demand, intense competition and excess manufacturing capacity have resulted in reduced prices, excluding raw material surcharges, for many of our products. These factors have had and may have an adverse impact on our revenues, operating results and financial condition.

Although inflationary trends in recent years have been moderate, during most of the same period certain critical raw material costs, such as nickel, titanium sponge, chromium, and molybdenum and scrap containing iron, nickel, titanium, chromium, and molybdenum have been volatile and at historically high levels. While we have been able to mitigate some of the adverse impact of rising raw material costs through raw material surcharges or indices to customers, rapid increases in raw material costs may adversely affect our results of operations.

We change prices on certain of our products from time-to-time. The ability to implement price increases is dependent on market conditions, economic factors, raw material costs and availability, competitive factors, operating costs and other factors, some of which are beyond our control. The benefits of any price increases may be delayed due to long manufacturing lead times and the terms of existing contracts.

***Risks Associated with Commercial Aerospace.*** A significant portion of the sales of our High Performance Metals segment represents products sold to customers in the commercial aerospace industry. The commercial aerospace industry has historically been cyclical due to factors both external and internal to the airline industry. These factors include general economic conditions, airline profitability, consumer demand for air travel, varying fuel and labor costs, price competition, and international and domestic political conditions such as military conflict and the threat of terrorism. The length and degree of cyclical fluctuation are influenced by these factors and therefore are difficult to predict with certainty. Demand for our products in this segment is subject to these cyclical trends. A downturn in the commercial aerospace industry has had, and may in the future have, an adverse effect on the prices at which we are

able to sell these and other products, and our results of operations, business and financial condition could be materially adversely affected.

**Risks Associated with Strategic Capital Projects.** From time-to-time, we undertake strategic capital projects in order to enhance, expand and/or upgrade our facilities and operational capabilities. For instance, over the past five years we have undertaken major expansions of our titanium and premium-melt nickel-based alloy, superalloy and specialty alloy production capabilities, and commenced construction of a new advanced specialty metals hot rolling and processing facility. Our ability to achieve the anticipated increased revenues or otherwise realize acceptable returns on these investments or other strategic capital projects that we may undertake is subject to a number of risks, many of which are beyond our control, including a variety of market, operational, permitting, and labor related factors. In addition, the cost to implement any given strategic capital project ultimately may prove to be greater than originally anticipated. If we are not able to achieve the anticipated results from the implementation of any of our strategic capital projects, or if we incur unanticipated implementation costs, our results of operations and financial position may be materially adversely affected.

**Dependence on Critical Raw Materials Subject to Price and Availability Fluctuations.** We rely to a substantial extent on third parties to supply certain raw materials that are critical to the manufacture of our products. Purchase prices and availability of these critical raw materials are subject to volatility. At any given time we may be unable to obtain an adequate supply of these critical raw materials on a timely basis, on price and other terms acceptable, or at all.

If suppliers increase the price of critical raw materials, we may not have alternative sources of supply. In addition, to the extent that we have quoted prices to customers and accepted customer orders for products prior to purchasing necessary raw materials, or have existing contracts, we may be unable to raise the price of products to cover all or part of the increased cost of the raw materials.

The manufacture of some of our products is a complex process and requires long lead times. As a result, we may experience delays or shortages in the supply of raw materials. If unable to obtain adequate and timely deliveries of required raw materials, we may be unable to timely manufacture sufficient quantities of products. This could cause us to lose sales, incur additional costs, delay new product introductions, or suffer harm to our reputation.

We acquire certain important raw materials that we use to produce specialty materials, including nickel, chromium, cobalt, and titanium sponge, from foreign sources. Some of these sources operate in countries that may be subject to unstable political and economic conditions. These conditions may disrupt supplies or affect the prices of these materials.

**Volatility of Raw Material Costs.** The prices for many of the raw materials we use have been extremely volatile. Since we value most of our inventory utilizing the last-in, first-out (LIFO) inventory costing methodology, a rapid rise in raw material costs has a negative effect on our operating results. Under the LIFO inventory valuation method, changes in the cost of raw materials and production activities are recognized in cost of sales in the current period even though these material and other costs may have been incurred at significantly different values due to the length of time of our production cycle. For example in 2010, the increase in raw material costs on the LIFO inventory valuation method resulted in cost of sales which was \$60.2 million higher than would have been recognized if we utilized the FIFO methodology to value our inventory. Conversely, in 2011, the decrease in raw material costs on the LIFO inventory valuation method resulted in cost of sales which were \$9.3 million lower than would have been recognized if we utilized the FIFO methodology to value our inventory. In a period of rising raw material prices, cost of sales expense recognized under LIFO is generally higher than the cash costs incurred to acquire the inventory sold. However, in a period of declining raw material prices, cost of sales recognized under LIFO is generally lower than cash costs incurred to acquire the inventory sold.

**Availability of Energy Resources.** We rely upon third parties for our supply of energy resources consumed in the manufacture of our products. The prices for and availability of electricity, natural gas, oil and other energy resources are subject to volatile market conditions. These market conditions often are affected by political and economic factors beyond our control. Disruptions in the supply of energy resources could temporarily impair the ability to manufacture products for customers. Further, increases in energy costs, or changes in costs relative to energy costs paid by competitors, has and may continue to adversely affect our profitability. To the extent that these uncertainties cause suppliers and customers to be more cost sensitive, increased energy prices may have an adverse effect on our results of operations and financial condition.

**Risks Associated with Environmental Matters.** We are subject to various domestic and international environmental laws and regulations that govern the discharge of pollutants, and disposal of wastes, and which may require that we investigate and remediate the effects of the release or disposal of materials at sites associated with past and present operations. We could incur substantial cleanup costs, fines and civil or criminal sanctions, third party property damage or personal injury claims as a result of violations or liabilities under these laws or non-compliance with environmental permits required at our facilities. We are currently involved in the investigation and remediation of a number of our current and former sites as well as third party sites. We also could be subject to future laws and regulations that govern greenhouse gas emissions and various matters related to climate change, which could increase our operating costs.

With respect to proceedings brought under the federal Superfund laws, or similar state statutes, we have been identified as a potentially responsible party (PRP) at approximately 36 of such sites, excluding those at which we believe we have no future liability. Our involvement is limited or de minimis at approximately 27 of these sites, and the potential loss exposure with respect to any of the remaining 9 individual sites is not considered to be material.

We are a party to various cost-sharing arrangements with other PRPs at the sites. The terms of the cost-sharing arrangements are subject to non-disclosure agreements as confidential information. Nevertheless, the cost-sharing arrangements generally require all PRPs to post financial assurance of the performance of the obligations or to pre-pay into an escrow or trust account their share of anticipated site-related costs. In addition, the Federal government, through various agencies, is a party to several such arrangements.

We believe that we operate our businesses in compliance in all material respects with applicable environmental laws and regulations. However, from time-to-time, we are a party to lawsuits and other proceedings involving alleged violations of, or liabilities arising from environmental laws. When our liability is probable and we can reasonably estimate our costs, we record environmental liabilities in our financial statements. In many cases, we are not able to determine whether we are liable, or if liability is probable, to reasonably estimate the loss or range of loss. Estimates of our liability remain subject to additional uncertainties, including the nature and extent of site contamination, available remediation alternatives, the extent of corrective actions that may be required, and the participation number and financial condition of other PRPs, as well as the extent of their responsibility for the remediation. We intend to adjust our accruals to reflect new information as appropriate. Future adjustments could have a material adverse effect on our results of operations in a given period, but we cannot reliably predict the amounts of such future adjustments. At December 31, 2011, our reserves for environmental matters totaled approximately \$15 million. Based on currently available information, we do not believe that there is a reasonable possibility that a loss exceeding the amount already accrued for any of the sites with which we are currently associated (either individually or in the aggregate) will be an amount that would be material to a decision to buy or sell our securities. Future developments, administrative actions or liabilities relating to environmental matters, however, could have a material adverse effect on our financial condition or results of operations.

**Risks Associated with Current or Future Litigation and Claims.** A number of lawsuits, claims and proceedings have been or may be asserted against us relating to the conduct of our currently and formerly owned businesses, including those pertaining to product liability, patent infringement, commercial, government contracting work, employment, employee and retiree benefits, taxes, environmental, health and safety and occupational disease, and stockholder matters. Due to the uncertainties of litigation, we can give no assurance that we will prevail on all claims made against us in the lawsuits that we currently face or that additional claims will not be made against us in the future. While the outcome of litigation cannot be predicted with certainty, and some of these lawsuits, claims or proceedings may be determined adversely to us, we do not believe that the disposition of any such pending matters is likely to have a material adverse effect on our financial condition or liquidity, although the resolution in any reporting period of one or more of these matters could have a material adverse effect on our results of operations for that period. Also, we can give no assurance that any other matters brought in the future will not have a material effect on our financial condition, liquidity or results of operations.

**Labor Matters.** We have approximately 11,400 full-time employees, of which approximately 15% are located outside the United States. Approximately 47% of our workforce is covered by various collective bargaining agreements, principally with the United Steel, Paper and Forestry, Rubber, Manufacturing, Energy, Allied Industrial and Service Workers International Union (“USW”). During 2011, we finalized new collective bargaining agreements with USW-represented production, office and maintenance employees at our Allegheny Ludlum operations in the Flat-Rolled Products segment that extend through June 30, 2015. We also finalized new six-year collective bargaining agreements for represented employees at ATI Ladish Forging, which will take effect as the current agreement with each bargaining unit expires, and extend to either 2018 or 2019, as applicable.

Generally, collective bargaining agreements that expire may be terminated after notice by the union. After termination, the union may authorize a strike. A strike by the employees covered by one or more of the collective bargaining agreements could have a materially adverse effect on our operating results. There can be no assurance that we will succeed in concluding collective bargaining agreements with the unions to replace those that expire.

**Export Sales.** We believe that export sales will continue to account for a significant percentage of our future revenues. Risks associated with export sales include: political and economic instability, including weak conditions in the world’s economies; accounts receivable collection; export controls; changes in legal and regulatory requirements; policy changes affecting the markets for our products; changes in tax laws and tariffs; trade duties; and exchange rate fluctuations (which may affect sales to international customers and the value of profits earned on export sales when converted into dollars). Any of these factors could materially adversely affect our results for the period in which they occur.

**Risks Associated with Retirement Benefits.** At December 31, 2011, our U.S. qualified defined benefit plan was approximately 84% funded and we are not required to make any contribution to this plan in 2012. However, we may be required to fund the U.S. qualified defined benefit pension plan in the years beyond 2012 depending upon the value of plan investments and obligations in the future and changes in laws or regulations that govern pension plan funding. Depending on the timing and amount, a requirement that we fund our U.S. qualified defined benefit pension plan could have a material adverse effect on our results of operations and financial condition.



**Risks Associated with Acquisition and Disposition Strategies.** We intend to continue to strategically position our businesses in order to improve our ability to compete. Strategies we employ to accomplish this may include seeking new or expanding existing specialty market niches for our products, expanding our global presence, acquiring businesses complementary to existing strengths and continually evaluating the performance and strategic fit of our existing business units. From time-to-time, management holds discussions with management of other companies to explore acquisition, joint ventures, and other business combination opportunities as well as possible business unit dispositions. As a result, the relative makeup of the businesses comprising our Company is subject to change. Acquisitions, joint ventures, and other business combinations involve various inherent risks, such as: assessing accurately the value, strengths, weaknesses, contingent and other liabilities and potential profitability of acquisition or other transaction candidates; the potential loss of key personnel of an acquired business; our ability to achieve identified financial and operating synergies anticipated to result from an acquisition or other transaction; and unanticipated changes in business and economic conditions affecting an acquisition or other transaction. International acquisitions and other transactions could be affected by export controls, exchange rate fluctuations, domestic and foreign political conditions and a deterioration in domestic and foreign economic conditions.

**Internal Controls Over Financial Reporting.** Because of its inherent limitations, internal control over financial reporting may not prevent or detect misstatements. Also, projections of any evaluation of effectiveness to future periods are subject to the risk that controls may become inadequate because of changes in conditions, or that the degree of compliance with the policies or procedures may deteriorate.

**Insurance.** We have maintained various forms of insurance, including insurance covering claims related to our properties and risks associated with our operations. Our existing property and liability insurance coverages contain exclusions and limitations on coverage. From time-to-time, in connection with renewals of insurance, we have experienced additional exclusions and limitations on coverage, larger self-insured retentions and deductibles and significantly higher premiums. As a result, in the future our insurance coverage may not cover claims to the extent that it has in the past and the costs that we incur to procure insurance may increase significantly, either of which could have an adverse effect on our results of operations.

**Political and Social Turmoil.** The war on terrorism and recent political and social turmoil could put pressure on economic conditions in the United States and worldwide. These political, social and economic conditions could make it difficult for us, our suppliers and our customers to forecast accurately and plan future business activities, and could adversely affect the financial condition of our suppliers and customers and affect customer decisions as to the amount and timing of purchases from us. As a result, our business, financial condition and results of operations could be materially adversely affected.

**Risks Associated with Government Contracts.** Some of our operating companies perform contractual work directly for the U.S. Government. Various claims (whether based on U.S. Government or Company audits and investigations or otherwise) could be asserted against us related to our U.S. Government contract work. Depending on the circumstances and the outcome, such proceedings could result in fines, penalties, compensatory and treble damages or the cancellation or suspension of payments under one or more U.S. Government contracts. Under government regulations, a company, or one or more of its operating divisions or units, can also be suspended or debarred from government contracts based on the results of investigations. Currently, there is no material portion of our business with the U.S. Government which might be subject to renegotiation of profits or termination of contracts or subcontracts at the election of the U.S. Government.

## **Item 1B. Unresolved Staff Comments**

None.

## **Item 2. Properties**

Our principal domestic facilities for our high performance metals include titanium sponge production, melting operations, and production facilities that include processing and finishing operations. Titanium sponge production facilities are located at Rowley, UT and Albany, OR. Domestic melting operations are located in Monroe, NC, Bakers, NC, and Lockport, NY (vacuum induction melting, vacuum arc re-melt, electro-slag re-melt, plasma melting); Richland, WA (electron beam melting); and Albany, OR (vacuum arc re-melt). Production of high performance metals, most of which are in long product form, takes place at our domestic facilities in Monroe, NC, Lockport, NY, Richburg, SC, Albany, OR, and Oakdale, PA. Our production of exotic alloys takes place at facilities located in Albany, OR, Huntsville, AL, and Frackville, PA. Our production of highly engineered forgings, castings, and machined components takes place at facilities in Cudahy and Coon Valley, WI, Windsor, CT, Albany, OR, and Irvine, CA.

Our principal domestic locations for melting stainless steel and other flat-rolled specialty metals are located in Brackenridge, Midland and Latrobe, PA. Hot rolling of material is performed at our domestic facilities in Brackenridge, Washington and Houston, PA. Finishing of our flat-rolled products takes place at our domestic facilities located in Brackenridge, Bagdad, Vandergrift, Midland and Washington, PA, and in Wallingford and Waterbury, CT, New Castle, IN, New Bedford, MA, and Louisville, OH. We are constructing a new advanced specialty metals hot rolling and processing facility for our Flat-Rolled Products business segment at our existing Brackenridge, PA site. This investment, which is expected to be completed by the end of 2013, is designed to produce

exceptional quality, thinner, and wider hot-rolled coils at reduced cost with shorter lead times and require lower working capital requirements.

Our principal domestic facilities for the production of our engineered products are located in Nashville, TN, Huntsville, Grant and Gurley, AL, Houston, TX, and Waynesboro, PA (tungsten powder, tungsten carbide materials and carbide cutting tools and threading systems). Other domestic facilities in this segment are located in Portland, IN and Lebanon, KY (carbon alloy steel forgings); LaPorte, IN and Alpena, MI (grey and ductile iron castings), and southwestern Pennsylvania (precision metals finishing services).

Substantially all of our properties are owned, and three of our properties are subject to mortgages or similar encumbrances securing borrowings under certain industrial development authority financings.

We also own or lease facilities in a number of foreign countries, including France, Germany, Switzerland, United Kingdom, Poland, and the People's Republic of China. We own and/or lease and operate facilities for melting and re-melting, machining and bar mill operations, laboratories and offices located in Sheffield, England. We own highly engineered forging and machining operations in Stalowa Wola, Poland. Through our STAL joint venture, we operate facilities for finishing Precision Rolled Strip products in the Xin-Zhuang Industrial Zone, Shanghai, China.

Our executive offices, located in PPG Place in Pittsburgh, PA, are leased.

Although our facilities vary in terms of age and condition, we believe that they have been well maintained and are in sufficient condition for us to carry on our activities.

### **Item 3. Legal Proceedings**

In December 2008, the Environmental Protection Agency (EPA) sent a subsidiary of the Company a notice of violation (NOV) alleging violations of rules governing the management of hazardous wastes at the entity's Albany, Oregon facility. In May 2010, the EPA sent a second NOV alleging additional violations of hazardous waste rules arising out of related circumstances, and a separate NOV to another subsidiary, which alleged violations of the hazardous waste rules at their Albany, Oregon facility. The Company and the EPA are discussing resolution of these NOVs.

We become involved from time-to-time in various lawsuits, claims and proceedings relating to the conduct of our current and formerly owned businesses, including those pertaining to product liability, patent infringement, commercial, employment, employee and retiree benefits, taxes, environmental, health and safety and occupational disease, and stockholder matters. While we cannot predict the outcome of any lawsuit, claim or proceeding, our management believes that the disposition of any pending matters is not likely to have a material adverse effect on our financial condition or liquidity. The resolution in any reporting period of one or more of these matters, including those described above, however, could have a material adverse effect on our results of operations for that period.

Information relating to legal proceedings is included in Note 17. Commitments and Contingencies of the Notes to Consolidated Financial Statements and incorporated herein by reference.

### **Item 4. Mine Safety Disclosures**

Not applicable.

## PART II

### Item 5. Market for the Registrant's Common Equity, Related Stockholder Matters and Issuer Purchases of Equity Securities

#### Common Stock Prices

Our common stock is traded on the New York Stock Exchange (symbol ATI). At February 7, 2012, there were 4,668 record holders of Allegheny Technologies Incorporated common stock. We paid a quarterly cash dividend of \$0.18 per share of common stock for each quarter of 2010 and 2011. The ranges of high and low sales prices for shares of our common stock for the periods indicated were as follows:

2011	March 31	June 30	September 30	December 31
High	\$ 69.75	\$ 73.53	\$ 66.39	\$ 51.25
Low	\$ 53.73	\$ 57.66	\$ 35.91	\$ 30.79

2010	March 31	June 30	September 30	December 31
High	\$ 56.23	\$ 58.25	\$ 53.41	\$ 59.41
Low	\$ 39.00	\$ 44.01	\$ 39.35	\$ 45.19

#### Purchases of Equity Securities by the Issuer and Affiliated Purchasers

Set forth below is information regarding the Company's stock repurchases during the period covered by this report, comprising shares repurchased by ATI from employees to satisfy employee-owed taxes on share-based compensation and activity under ATI's publicly announced share repurchase program, which was formally terminated in September 2011. There were no share repurchases under this program in 2009, 2010 or 2011.

Period	Total Number of Shares Purchased	Average Price Paid per Share	Total Number of Shares Purchased as Part of Publicly Announced Plans or Programs	Approximate Dollar Value of Shares that May Yet Be Purchased Under the Plans or Programs
January 1-31, 2011	20,905	\$ 64.35	-	\$ 160,505,939
February 1-28, 2011	-	-	-	160,505,939
March 1-31, 2011	-	-	-	160,505,939
Quarter ended March 31, 2011	20,905	64.35	-	160,505,939
April 1-30, 2011	-	-	-	160,505,939
May 1-31, 2011	-	-	-	160,505,939
June 1-30, 2011	-	-	-	160,505,939
Quarter ended June 30, 2011	-	-	-	160,505,939
July 1-31, 2011	-	-	-	160,505,939
August 1-31, 2011	-	-	-	160,505,939
September 1-30, 2011	-	-	-	- (a)
Quarter ended September 30, 2011	-	-	-	-
October 1-31, 2011	-	-	-	-
November 1-30, 2011	-	-	-	-
December 1-31, 2011	20,561	43.42	-	-
Quarter ended December 31, 2011	20,561	\$ 43.42	-	\$ -

(a) In September 2011, ATI's Board of Directors approved the termination of the share repurchase program, originally approved in November 2007 for up to \$500 million. Prior to the termination of this Plan, 6,837,000 shares of common stock had been purchased under this program at a cost of \$339.5 million. All of these purchases were made in the open market.

#### Cumulative Total Stockholder Return

The graph set forth below shows the cumulative total stockholder return (i.e., price change plus reinvestment of dividends) on our common stock from December 31, 2006 through December 31, 2011 as compared to the S&P 500 Index and a Peer Group of companies. We believe the Peer Group of companies, which is defined below, is representative of companies in our industry that serve similar markets during the applicable periods. The total stockholder return for the Peer Group is weighted according to the respective issuer's stock market capitalization at the beginning of each period. The graph assumes that \$100 was invested on December 31, 2006.



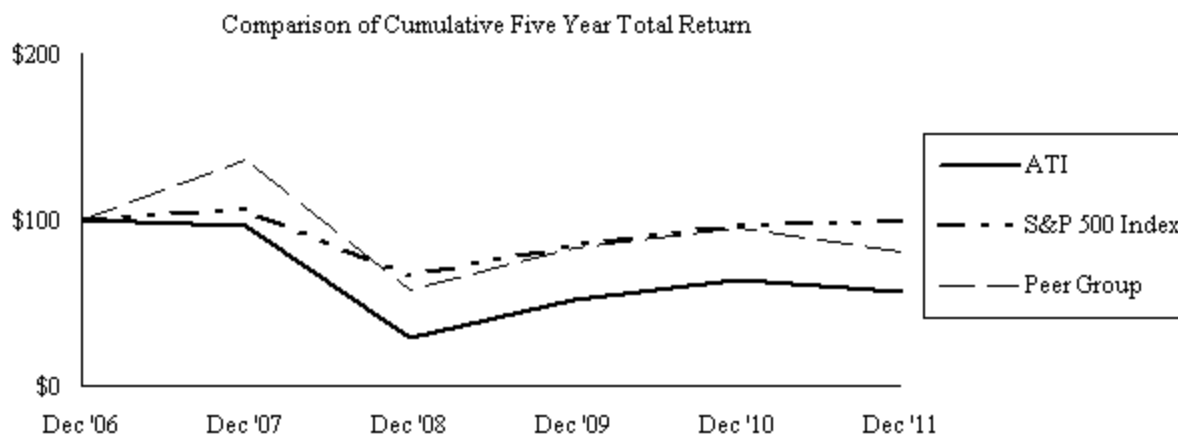

Company / Index	Dec '06	Dec '07	Dec '08	Dec '09	Dec '10	Dec '11
ATI	100.00	95.82	28.76	51.57	64.44	56.61
S&P 500 Index	100.00	105.49	66.46	84.05	96.71	98.76
Peer Group	100.00	135.62	58.00	83.01	94.58	80.47

Source: Standard & Poor's

Demand for our products is cyclical over longer periods because specialty metals customers operate in cyclical industries and are subject to changes in general economic conditions and other factors both external and internal to those industries, specifically the economic crisis of 2008. The graph set forth below shows the cumulative total stockholder return (i.e., price change plus reinvestment of dividends) on our common stock from December 31, 2008 through December 31, 2011 as compared to the S&P 500 Index and a Peer Group of companies. The graph serves as a supplement to the five year graph above and assumes that \$100 was invested on December 31, 2008.

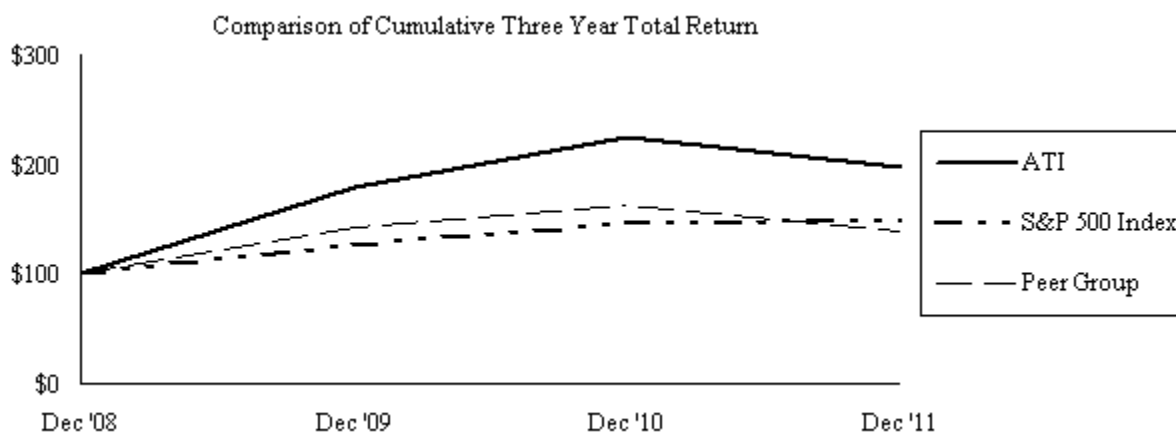

Company / Index	Dec '08	Dec '09	Dec '10	Dec '11
ATI	100.00	179.33	224.09	196.85
S&P 500 Index	100.00	126.46	145.51	148.59
Peer Group	100.00	143.13	163.09	138.76

Source: Standard & Poor's

Peer Group companies for the cumulative three and five year total return periods ended December 31, 2011 were as follows:

AK Steel Holding Corp.	Materion Corp	Steel Dynamics Inc.
ALCOA Inc.	Nucor Corp.	Timken Co.
Carpenter Technology Corp.	Precision Castparts Corp.	Titanium Metals Corp.
Castle (A M) & Co.	Reliance Steel & Aluminum Co.	United States Steel Corp.
Commercial Metals	RTI International Metals Inc.	Universal Stainless & Alloy Products
Kennametal Inc.	Schnitzer Steel Industries - CL A	Worthington Industries

## Item 6. Selected Financial Data

The following table sets forth selected volume, price and financial information for ATI. The financial information has been derived from our audited financial statements included elsewhere in this report for the years ended December 31, 2011, 2010, and 2009. The historical selected financial information may not be indicative of our future performance and should be read in conjunction with the information contained in Item 7. Management's Discussion and Analysis of Financial Condition and Results of Operations, and in Item 8. Financial Statements and Supplementary Data.

For the Years Ended December 31,	2011	2010	2009	2008	2007
Volume (000's lbs.):					
High Performance Metals - titanium mill products	26,518	25,457	23,588	32,530	30,689
High Performance Metals - nickel-based and specialty alloys	47,913	37,272	32,562	42,525	44,688
High Performance - exotic alloys	4,094	4,382	5,067	5,473	5,169
Flat Rolled Products:					
High value	497,079	454,874	367,195	500,375	491,891
Standard	587,648	642,255	474,950	584,389	557,016
Flat-Rolled Products total	1,084,727	1,097,129	842,145	1,084,764	1,048,907
Average Prices (per lb.):					
High Performance Metals - titanium mill products	\$ 22.01	\$ 19.37	\$ 20.92	\$ 25.60	\$ 30.14
High Performance Metals - nickel-based and specialty alloys	15.58	14.03	14.43	18.14	19.16
High Performance - exotic alloys	66.31	60.68	57.79	48.53	41.85
Flat Rolled Products:					
High value	3.32	2.83	2.49	3.26	3.22
Standard	1.80	1.62	1.22	2.13	2.40
Flat-Rolled Products combined average	2.49	2.12	1.77	2.65	2.79

*(In millions except per share amounts)*

For the Years Ended December 31,	2011	2010	2009	2008	2007
Sales:					
High Performance Metals	\$ 1,955.9	\$ 1,337.5	\$ 1,300.0	\$ 1,944.9	\$ 2,067.6
Flat-Rolled Products	2,726.0	2,338.5	1,516.1	2,909.1	2,951.9
Engineered Products	501.1	371.8	238.8	455.7	433.0
Total Sales	\$ 5,183.0	\$ 4,047.8	\$ 3,054.9	\$ 5,309.7	\$ 5,452.5
Operating profit (loss):					
High Performance Metals	\$ 364.5	\$ 257.8	\$ 234.7	\$ 539.0	\$ 729.1
Flat-Rolled Products	213.4	85.9	71.3	385.0	512.0
Engineered Products	34.1	12.8	(23.8)	20.9	32.1
Total operating profit	\$ 612.0	\$ 356.5	\$ 282.2	\$ 944.9	\$ 1,273.2
Income before income taxes	\$ 339.4	\$ 125.7	\$ 64.9	\$ 867.7	\$ 1,154.1
Net income	223.1	78.7	38.0	573.5	753.9
Less: Net income attributable to noncontrolling interests	8.8	8.0	6.3	7.6	6.8
Net income attributable to ATI	214.3	70.7	31.7	565.9	747.1
Basic net income per common share	2.09	0.73	0.33	5.71	7.35
Diluted net income per common share	1.97	0.72	0.32	5.67	7.26

(In millions except per share amounts and ratios)

As of and for the Years Ended December 31,	2011	2010	2009	2008	2007
Dividends declared per common share	\$ 0.72	\$ 0.72	\$ 0.72	\$ 0.72	\$ 0.57
Ratio of earnings to fixed charges	3.8x	2.2x	1.5x	19.4x	25.0x
Working capital	\$ 1,707.7	\$ 1,324.1	\$ 1,373.0	\$ 1,235.5	\$ 1,544.7
Total assets	6,046.9	4,493.6	4,346.0	4,170.4	4,095.6
Long-term debt	1,482.0	921.9	1,037.6	494.6	507.3
Total debt	1,509.3	1,063.3	1,071.1	509.8	528.2
Cash and cash equivalents	380.6	432.3	708.8	469.9	623.3
Total ATI Stockholders' equity	2,475.3	2,040.8	2,012.2	1,957.4	2,222.0
Noncontrolling interests	96.3	88.6	77.4	71.6	57.2
Total Stockholders' equity	2,571.6	2,129.4	2,089.6	2,029.0	2,279.2

In May 2011, we acquired Ladish Co., Inc. for \$897.6 million, comprised of the issuance of 7.3 million shares of ATI common stock, which increased ATI stockholders' equity by \$513.6 million, and the payment of \$384 million in cash. ATI Ladish results are included in the High Performance Metals segment from the date of the acquisition.

In 2011, we issued \$500 million of 5.95% Senior Notes due January 15, 2021. A portion of the proceeds from this transaction were used to fund the cash portion of the Ladish acquisition. Additionally, in 2011 we retired the remaining \$117 million of our outstanding 8.375% Notes that matured in December 2011.

ATI stockholders' equity for 2011 included a \$320.0 million net decrease for the year-end remeasurement of pensions and other postretirement benefits. ATI stockholders' equity for 2008 included a \$424.9 million net decrease for the year-end remeasurement of pensions and other postretirement benefits.

In 2009, we completed several proactive liability management actions including the issuance of \$350 million of 9.375% 10-year Senior Notes and \$402.5 million of 4.25% 5-year Convertible Senior Notes. Proceeds from these transactions were used to retire \$183.3 million of our outstanding 8.375% Notes due in 2011 and to fund a voluntary pretax \$350 million cash contribution to our domestic pension plan to significantly improve its funded position.

For purposes of determining the ratio of earnings to fixed charges, earnings include pre-tax income plus fixed charges (excluding capitalized interest). Fixed charges consist of interest on all indebtedness (including capitalized interest) plus that portion of operating lease rentals representative of the interest factor (deemed to be one-third of operating lease rentals).

## Item 7. Management's Discussion and Analysis of Financial Condition and Results of Operations

Certain statements contained in this Management's Discussion and Analysis of Financial Condition and Results of Operations are forward-looking statements. Actual results or performance could differ materially from those encompassed within such forward-looking statements as a result of various factors, including those described below. Net income and net income per share amounts referenced below are attributable to Allegheny Technologies Incorporated.

### Overview of 2011 Financial Performance

Results for 2011 reflect our continued growth in key global markets through strategic investments, from both internal expansion and acquisitions. We acquired Ladish Co., Inc. (now ATI Ladish) in May 2011, which added advanced forgings, titanium investment castings and precision finishing capabilities to ATI's product portfolio within our High Performance Metals business segment. Net income attributable to ATI for the full year 2011 increased to \$214.3 million, or \$1.97 per share, compared to \$70.7 million, or \$0.72 per share, for 2010. Results for 2011 included \$29.6 million, net of tax, for Ladish acquisition expenses and other charges. Sales in 2011 increased 28% to \$5.18 billion compared to \$4.05 billion for 2010. Direct international sales for 2011 increased \$530.5 million and represented 35% of our total sales. For 2011, the Flat-Rolled Products segment generated 51%, the High Performance Metals segment generated 43%, and the Engineered Products segment generated 6% of our direct international sales.

Our 2011 results reflect ATI's position as a globally focused, diversified high-value specialty metals company with strong cash flow and liquidity, and a solid balance sheet. The aerospace and defense market and the global infrastructure markets, specifically oil and gas, chemical process industry, electrical energy, and the medical market, have been driving our performance for the last several years, and represented 70% of ATI's 2011 sales. For 2011, sales to the aerospace and defense market grew 44% and represented 29% of our sales, as the acquisition of ATI Ladish augmented organic growth. Sales in 2011 to the oil and gas and chemical process industry markets grew 41%, representing 21% of ATI sales. Our 2011 sales to our other key growth markets also increased, with 16%



growth to the electrical energy market, representing 15% of ATI sales, and 8% growth to the medical market, representing 5% of ATI sales.

In our High Performance Metals segment, sales in 2011 increased 46% to \$1.96 billion, due to ATI Ladish sales and improved overall demand from the commercial aerospace jet engine market, both for new aircraft builds and replacement spares as a result of increased flight activity. Sales to the electrical energy market increased 86%, driven by demand for land-based natural gas turbines. In addition, demand increased from the oil and gas market, reflecting the trend toward directional drilling, deep water projects and sour gas projects, and in the medical market for implants and imaging equipment. Demand was lower for our materials from the chemical processing market due to project-specific activity. Operating profit for the High Performance Metals segment was \$364.5 million, or 18.6% of sales, a 41% increase compared to 2010, due primarily to higher shipments for most of our products, a favorable product mix, improved selling prices and the benefits from our gross cost reductions. Operating profit was impacted by inventory fair value adjustments associated with the Ladish transaction of \$27.3 million, and start-up and idle facility costs of \$31.7 million associated with our primary titanium sponge operations. The start-up costs relate mostly to our Rowley, UT premium-titanium sponge facility. The facility remains on track to complete the standard grade qualification by the end of the 2012 first quarter. With stable raw material input costs, higher production rates, and improved plant efficiencies, we expect to produce more titanium sponge at lower costs in 2012, compared to 2011. Idle facility costs relate mostly to our Albany, OR titanium sponge facility, which is positioned to be back in production when warranted by market conditions.

In our Flat-Rolled Products segment, sales increased 17% to \$2.73 billion primarily as a result of increased high-value product shipments to the oil and gas, chemical process industry and aerospace markets. Total product shipments decreased 1% for the full year 2011, as shipments of high-value products increased 9% while shipments of standard stainless products declined 9%. Volatile raw material costs and the resulting impact on surcharges affected customer buying behavior during the second half of the year as they managed inventory levels and the timing of purchases. Operating profit for the Flat-Rolled Products segment increased to \$213.4 million, a 148% increase compared to 2010. The improvement in 2011 operating profit was due primarily to higher shipments of high value products, a better matching of raw material prices with surcharges, and the benefits from our gross cost reduction efforts. Operating results for 2011 included a LIFO inventory valuation reserve benefit of \$34.7 million, compared to a \$70.7 million LIFO inventory valuation charge in 2010.

In our Engineered Products segment, 2011 sales increased 35% to \$501.1 million, primarily due to increased demand from all the major markets for our products: oil and gas, transportation, construction and mining, and cutting tools. The significant sales increase resulted in an operating profit of \$34.1 million for 2011, a 166% increase compared to 2010.

For 2011, total segment operating profit increased 72% to \$612.0 million compared to \$356.5 million for 2010.

During 2011, we strengthened our positions in key global growth markets, continued to enhance our manufacturing capabilities, reduced costs, and maintained our strong balance sheet. We also realized continued success in implementing the ATI Business System, which is continuing to drive lean manufacturing throughout our operations. Our accomplishments during 2011 from these important efforts included:

- Continued growth in our global market presence as direct international sales increased \$530.3 million to represent 35% of total sales. We believe at least 50% of ATI's 2011 sales were driven by global markets when we consider exports by our customers.
- Continued improvement in our positions with key customers in the aerospace, oil and gas, electrical energy, and medical markets as we entered into new long-term agreements for our Mission Critical Metallics<sup>®</sup>, to reduce their supply uncertainty. In June 2011, we announced a long-term sourcing agreement through 2024 with Rolls-Royce plc for the supply of ATI 718 Plus<sup>®</sup> alloy, a nickel-based superalloy that is used in static and rotating jet engine applications. In October 2011, we announced the extension of our titanium products supply agreement with The Boeing Company through the end of 2018. The extension agreement covers value-added titanium mill products and provides opportunity for greater use of ATI's highly engineered titanium cast and forged products.
- Continued expansion of our industry leading technology portfolio by making important research and development investments. ATI 718 Plus<sup>®</sup> alloy, our groundbreaking nickel-based superalloy, continued to gain acceptance in the marketplace and is being used on legacy and next-generation engines. We also continued our commercial developments of ATI 425<sup>®</sup> alloy, an innovative new cold-rollable titanium alloy that is now qualified for aerospace applications, and can be used for armor and defense applications where light weight, strength and formability are critical. These products are aimed at enabling customers to manufacture near-net-shapes more quickly and at reduced costs.
- We continued to realize significant benefits from our strategic focus on key high value specialty products, including titanium and titanium alloys, precision castings and forgings, nickel-based alloys and specialty alloys, exotic alloys, and grain-oriented electrical steel. In 2011, sales of these key high value products represented 75% of our total sales.
- We continued to build a foundation for profitable growth. We significantly increased strategic capital investments in our businesses to support the expected long-term growth in our markets, especially for titanium and titanium alloys, nickel-based

alloys and superalloys, and vacuum melted specialty alloys. Since 2004, we have transformed ATI by investing over \$3.3 billion in capital expenditures and acquisitions, of which \$1.2 billion was spent in 2011, to support this growth. Virtually all of these investments have been in the United States, and more than 78% has been self-funded. Significant among these investments are:

- The acquisition of Ladish Co., Inc. (Ladish) on May 9, 2011 for \$897.6 million through the issuance of 7.3 million shares of ATI common stock and payment of \$384 million in cash (\$349 million net of cash acquired). ATI Ladish results are included in the High Performance Metals segment from the date of the acquisition. Based in Wisconsin, ATI Ladish engineers, produces and markets high-strength, high technology forged and cast metal components for a wide variety of load-bearing and fatigue-resisting applications in the jet engine, aerospace and industrial markets, for both domestic and international customers. Ladish sales in 2010 were \$403.1 million. As a result of the acquisition, ATI is now a fully integrated supplier, from raw material (for titanium) and melt through highly engineered technically complex parts, creating a more integrated, stable and sustainable supply chain for aerospace, defense and industrial markets.
- The expansion of ATI's aerospace quality titanium sponge production capabilities. Titanium sponge is an important raw material used to produce our titanium mill products. Our greenfield premium-grade titanium sponge (jet engine rotating parts) facility in Rowley, UT, with a total cost of approximately \$500 million, continued to ramp up production during 2011, and we expect to complete the standard grade qualification process by the end of the first quarter 2012, to be followed by premium grade qualification. When this Utah sponge facility is fully operational, our total annual sponge production capacity, including our Albany, OR standard grade titanium sponge facility, is projected to be approximately 46 million pounds. These secure supply sources are intended to reduce our purchased titanium sponge and purchased titanium scrap requirements. In addition, the Utah facility will have the infrastructure in place to further expand annual capacity by approximately 18 million pounds, bringing the total annual capacity at that facility to 42 million pounds, if needed.
- The expansion of our High Performance Metals segment production capabilities in North Carolina. Our fourth cold-hearth plasma arc melt furnace for melting premium titanium alloys is in the qualification stage and is expected to support our growth in demand for high-value products in 2012. Our titanium alloys and nickel-based alloys and superalloys forging facility, which was constructed in phases through 2009 and is now fully in service, includes a new 10,000 ton press forge and a new 700mm radial forge, both of which we believe are the largest of their kind in the world for producing these types of alloys. The facility also includes billet conditioning and finishing equipment.
- The design and construction of a new advanced specialty metals hot-rolling and processing facility at our existing Flat-Rolled Products segment Brackenridge, PA site for approximately \$1.1 billion. The facility construction is progressing on schedule, with construction expected to be completed by the end of 2013 and commissioning occurring in the first half of 2014. The new hot-rolling and processing facility is designed to be the most powerful mill in the world for production of specialty metals. It is designed to produce exceptional quality, thinner, and wider hot-rolled coils at reduced cost with shorter lead times, and require lower working capital requirements. When completed, we believe ATI's new hot-rolling and processing facility will provide unsurpassed manufacturing capability and versatility in the production of a wide range of flat-rolled specialty metals. We expect improved productivity, lower costs, and higher quality for our diversified product mix of flat-rolled specialty metals, including nickel-based and specialty alloys, titanium and titanium alloys, zirconium alloys, Precision Rolled Strip<sup>®</sup> products, and stainless sheet and coiled plate products. It is designed to roll and process exceptional quality hot bands of up to 78.62 inches, or 2 meters, wide.

We currently plan to spend approximately \$485 million for capital expenditures in 2012, all of which we expect to fund from operating cash flow and available funds on hand, and we expect capital spending to remain at this level for each of the next few years while we complete our strategic capital projects.

- We realized significant cash generation in 2011, with cash flow from operations of \$297 million, which included investing \$273 million in managed working capital to meet the needs of a significant increase in business activity. We invested \$625 million in 2011, including \$349 million for the Ladish acquisition and \$278 million in capital expenditures.
- We continued to maintain our strong balance sheet. In January 2011, we sold \$500 million in aggregate principal amount of 5.95% Senior Notes due 2021, and realized net proceeds of \$495 million. We used these proceeds primarily to finance the cash portion of the merger consideration for Ladish. During 2011, we retired \$147 million of debt, including the remaining \$117 million of 8.375% Notes which matured in December 2011, and we made dividend payments to ATI stockholders of \$75 million.
- Cash on hand at the end of 2011 was \$381 million, a \$52 million decrease from year-end 2010. At the end of 2011, our percentages of net debt to total capitalization and total debt to total capital were 31.3% and 37.9%, respectively. Our U.S. defined benefit pension plan was approximately 84% funded, and we are not required to make any contributions to this plan for 2012.

- Our safety focus continued across all of ATI's operations. Our OSHA Total Recordable Incident Rate was 2.61 and our Lost Time Case Rate was 0.47 per 200,000 hours worked. ATI Allegheny Ludlum facilities recently completed a streak of over 13 million hours worked without a Lost Time accident.
- We realized continued success from the ATI Business System, which continues to drive lean manufacturing throughout our operations. In addition to the safety performance discussed above, we realized over \$123 million in gross cost reductions in 2011, which exceeded our goal of \$100 million. We have targeted additional gross cost reductions of at least \$100 million in 2012.

Our focus is to continue to deliver value for our customers and profitable growth for our stockholders. Our outlook for the commercial aerospace market remains bullish. We expect to benefit from increased build rates for legacy and next-generation aircraft and engines, and increased demand for aftermarket jet engine spare parts, as well as from development work on future-generation jet engines. Demand for our products generally leads a change to a production build schedule by approximately 6 to 12 months.

We expect demand from the global oil and gas and chemical process industries to remain strong. ATI benefits from the trend toward horizontal and directional drilling, deep water projects, and sour gas projects. In the chemical processing industry, ATI benefits from projects requiring specialty metals that can withstand highly corrosive and hot environments.

In the electrical energy market, we expect to benefit from growing global demand for safe, clean and efficient electrical energy. Our specialty metals are used in nuclear, coal, and natural gas power generation, including pollution control equipment and spent nuclear fuel storage. Demand for our products is growing from renewables, particularly solar and geothermal power. Demand for our products from the medical market is expected to remain strong because of the aging populations in developed countries and the growth of advanced medical procedures in developing countries requiring the products that we produce. We also expect to benefit from our ongoing market and product development activities aimed at introducing innovative new ATI alloys and extending our reach into our key global markets with product forms that are new to ATI. We intend to use these improving market conditions to continue to positively differentiate ATI as a uniquely positioned, diversified, technology-driven global specialty metals producer.

## Results of Operations

Sales were \$5.18 billion in 2011, \$4.05 billion in 2010, and \$3.05 billion in 2009. Direct international sales represented approximately 35% of 2011 sales, 32% of 2010 sales, and 31% of 2009 sales.

Segment operating profit was \$612.0 million in 2011, \$356.5 million in 2010, and \$282.2 million in 2009. Our measure of segment operating profit, which we use to analyze the performance and results of our business segments, excludes income taxes, corporate expenses, net interest expense, retirement benefit expense, other costs net of gains on asset sales and restructuring costs, if any. We believe segment operating profit, as defined, provides an appropriate measure of controllable operating results at the business segment level.

Income before tax was \$339.4 million in 2011, \$125.7 million in 2010, and \$64.9 million in 2009. Net income attributable to ATI was \$214.3 million in 2011, \$70.7 million for 2010, and \$31.7 million for 2009. Results for 2011 include after-tax charges of \$29.6 million, or \$0.26 per share, for Ladish acquisition expenses, accelerated recognition of equity compensation due to executive retirements, and restructuring and start-up expenses. Results in 2009 included after-tax charges of \$17.0 million, or \$0.17 per share, related to second quarter 2009 actions to retire debt and the tax consequences of our \$350 million voluntary pension contribution.

We operate in three business segments: High Performance Metals, Flat-Rolled Products and Engineered Products. These segments represented the following percentages of our total revenues and segment operating profit for the years indicated:

	2011		2010		2009	
	Revenue	Operating Profit	Revenue	Operating Profit	Revenue	Operating Profit (Loss)
High Performance Metals	38%	59%	33%	72%	43%	83%
Flat-Rolled Products	52%	35%	58%	24%	49%	25%
Engineered Products	10%	6%	9%	4%	8%	(8%)

Comparative information for our overall revenues (in millions) by end market and their respective percentages of total revenues were as follows:

Market	2011		2010		2009	
Aerospace & Defense	\$ 1,481.0	29%	\$ 1,027.5	25%	\$ 945.4	31%
Oil & Gas/Chemical Process Industry	1,107.0	21%	787.8	19%	581.7	19%
Electrical Energy	778.8	15%	670.9	17%	576.4	19%
Medical	253.0	5%	234.5	6%	122.5	4%
Subtotal - Key Markets	3,619.8	70%	2,720.7	67%	2,226.0	73%
Automotive	386.8	7%	319.7	8%	207.9	7%
Construction/Mining	321.6	6%	274.3	7%	148.1	5%
Food Equipment & Appliances	243.0	5%	277.8	7%	184.3	6%
Transportation	233.7	4%	169.8	4%	73.0	2%
Electronics/Computers/Communication	161.1	3%	130.4	3%	85.3	3%
Machine & Cutting Tools	136.3	3%	97.8	2%	64.9	2%
Conversion Services and Other	80.7	2%	57.3	2%	65.4	2%
Total	\$ 5,183.0	100%	\$ 4,047.8	100%	\$ 3,054.9	100%

Information with respect to our business segments is presented below.

### High Performance Metals

<i>(In millions)</i>	2011	% Change	2010	% Change	2009
Sales to external customers	\$ 1,955.9	46%	\$ 1,337.5	3%	\$ 1,300.0
Operating profit	364.5	41%	257.8	10%	234.7
Operating profit as a percentage of sales	18.6%		19.3%		18.1%
Direct international sales as a percentage of sales	40.1%		32.8%		32.8%

Our High Performance Metals segment produces, converts and distributes a wide range of high performance alloys, including titanium and titanium-based alloys, nickel- and cobalt-based alloys and superalloys, exotic alloys such as zirconium, hafnium, niobium, nickel-titanium, and their related alloys, advanced powder alloys and other specialty metals, in long product forms such as ingot, billet, bar, rod, wire, shapes and rectangles, and seamless tubes, plus precision forgings and castings, and machined parts. These products are designed for the high performance requirements of such major end markets as aerospace and defense, electrical energy, oil and gas, chemical process industry, and medical. The operating units in this segment are ATI Allvac, ATI Allvac Ltd (U.K.), ATI Ladish, ATI Wah Chang and ATI Powder Metals.

### 2011 Compared to 2010

Sales for the High Performance Metal segment for 2011 increased 46%, to \$1.96 billion, due to ATI Ladish sales and improved overall demand from the commercial aerospace jet engine market, both for new aircraft builds and replacement spares as a result of increased flight activity. Overall sales to the aerospace market increased 50% in 2011. Sales to the electrical energy market increased 86%, driven by demand for land-based natural gas turbines. In addition, demand increased from the oil and gas market, reflecting the trend toward directional drilling, deep water projects and sour gas projects, and in the medical market for implants and imaging equipment. Comparative information for our High Performance Metals segment revenues (in millions) by market, the respective percentages of overall segment revenues for the years ended 2011 and 2010, and the percentage change in revenues by market for 2011 is as follows:



Market	2011		2010		Change	
Aerospace:						
Jet Engines	\$ 667.7	34%	\$ 393.5	29%	\$ 274.2	70%
Airframes	304.3	15%	277.3	21%	27.0	10%
Government	188.8	10%	104.8	8%	84.0	80%
Total Aerospace	1,160.8	59%	775.6	58%	385.2	50%
Defense	98.2	5%	104.0	8%	(5.8)	(6%)
Oil & Gas/Chemical Process Industry	180.2	9%	145.7	11%	34.5	24%
Electrical Energy	177.4	9%	95.2	7%	82.2	86%
Medical	182.2	9%	143.6	11%	38.6	27%
Construction/Mining	36.1	2%	2.2	0%	33.9	1541%
Other	121.0	7%	71.2	5%	49.8	70%
Total	\$ 1,955.9	100%	\$ 1,337.5	100%	\$ 618.4	46%

Mill product shipment volumes increased for titanium and titanium alloys, and nickel-based and specialty alloys, while exotic alloys shipments were lower due to the timing of project-based demand in the chemical process industry. Average mill products selling prices for titanium and titanium alloys and nickel-based and specialty alloys increased primarily due to a favorable product mix, higher raw material indices and improving base prices. Average selling prices for exotic alloys increased primarily due to product mix. Comparative information on the segment's mill products for the years ended December 31, 2011 and 2010 is provided in the following table. Mill products volume and average price information includes shipments to ATI Ladish for all periods presented:

<i>For the Years Ended December 31,</i>	2011	2010	% Change
Mill Products Volume (000's pounds):			
Titanium	26,518	25,457	4%
Nickel-based and specialty alloys	47,913	37,272	29%
Exotic alloys	4,094	4,382	(7%)
Average prices (per pound):			
Titanium	\$ 22.01	\$ 19.37	14%
Nickel-based and specialty alloys	\$ 15.58	\$ 14.03	11%
Exotic alloys	\$ 66.31	\$ 60.68	9%

Aerospace represents a significant market for our High Performance Metals segment, especially for premium quality specialty metals used in the manufacture of jet engines for the original equipment and spare parts markets. In 2011 and 2010, the aerospace market represented 59% and 58%, respectively, of the revenues of the segment with products for jet engines representing the majority of the sales. In addition, we have become a larger supplier of specialty metals used in airframe construction. In 2011 and 2010, sales of our material into the airframe market represented approximately 26% and 36%, respectively of our aerospace market sales.

Over the past several years, we have entered into long-term agreements with our customers for Mission Critical Metallics® to reduce their supply uncertainty. During 2011, we extended our titanium products supply agreement for aircraft airframes and structural components with The Boeing Company through the end of 2018. The extension agreement covers value-added titanium mill products and provides opportunity for greater use of ATI's highly engineered titanium cast and forged products. This long-term agreement includes both long-product forms which are manufactured within the High Performance Metals segment, and a significant amount of plate products which are manufactured utilizing assets of both the High Performance Metals and Flat-Rolled Products segments. Revenues and profits associated with these titanium products covered by the long-term agreement are included primarily in the results for the High Performance Metals segment. In September 2009, we signed a ten-year sourcing agreement with Rolls-Royce plc for the supply of nickel-based superalloy disc-quality products for commercial jet engine applications with potential revenue estimated to be between \$750 million and \$1 billion. We also have a long-term agreement with GE Aviation for the supply of premium titanium alloys, nickel-based alloys, and vacuum-melted specialty alloys products for commercial and military jet engine applications.

The commercial aerospace market's use of titanium alloys is expected to increase significantly as new aircraft airframe designs use a larger percentage of titanium alloys. For example, the new Boeing 787 Dreamliner airframe (excluding engines) is expected to use significantly more titanium and titanium alloys as a percentage of total weight than any previous commercial aircraft airframe. New aircraft designs from Airbus, the A380 and A350-XWB, and from defense contractors are also expected to utilize a greater percentage of titanium alloys. Given the significant current backlogs of Boeing and Airbus, as well as the engine manufacturers, this increasing demand for titanium alloys mill products is expected to last for at least the next several years. Production difficulties for new aircraft

such as the Boeing 787, which experienced a production delay of approximately three years, along with decreased demand in the aeroengine aftermarket due to weakness in the global economy in late 2008 and through 2009, have resulted in excess availability of materials in the aerospace supply chain. This excess availability of material had an adverse effect on the demand and selling prices for certain of the materials we produce, especially titanium alloys and nickel-based superalloys. This supply condition also resulted in the temporarily idling our Albany, OR titanium sponge facility at the end of July 2009 to adjust our titanium production and inventory levels to market demand. During 2010 and 2011, aerospace market conditions began to improve as Boeing and Airbus began to ramp up production of legacy single aisle aircraft, such as the 737 and A320, to meet the demand of increasing backlogs for these aircraft. Additionally, the Boeing 787 entered service in late 2011, and production and deliveries of this aircraft are increasing. Both Boeing and Airbus have implemented production increases, and announced future production increases over the next several years for legacy and next generation aircraft, which is expected to positively benefit the demand for titanium alloys and nickel-based superalloys for both jet engine and airframe applications. Due to manufacturing cycle times, demand for our specialty metals leads the deliveries of new aircraft by between 6 to 12 months. In addition, as our specialty metals are used in rotating components of jet engines, demand for our products for spare parts is impacted by aircraft flight activity and engine refurbishment requirements of U.S. and foreign aviation regulatory authorities. As the number of aircraft in service increases, the need for our materials associated with engine refurbishment is expected to increase.

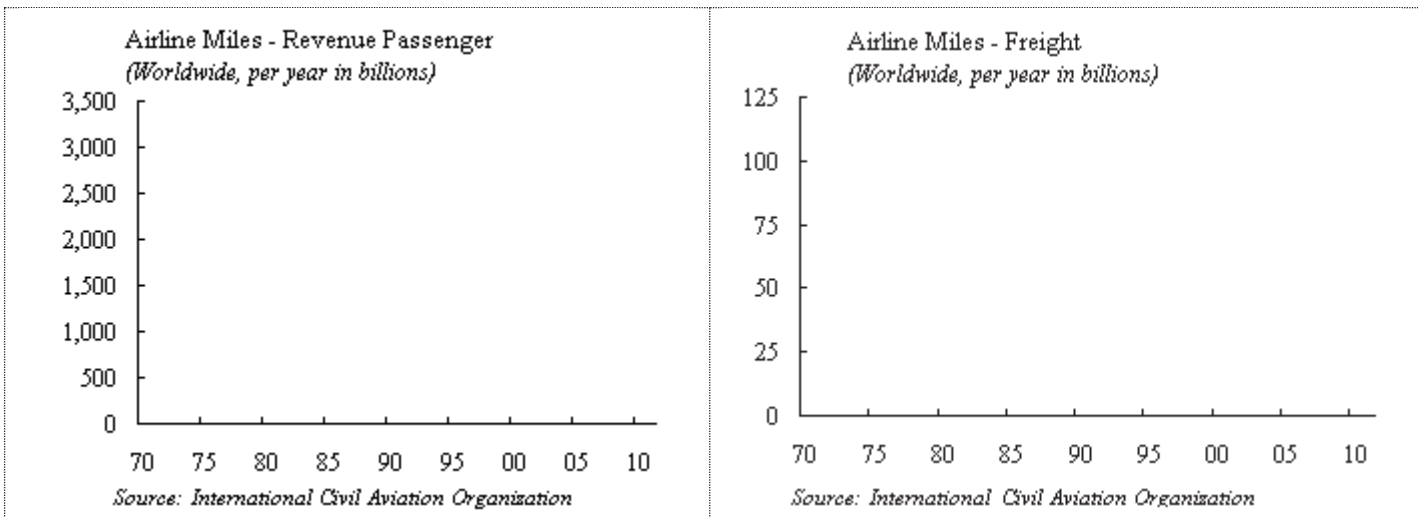

Airline Miles - Revenue Passenger (Worldwide, per year, in billions)

70	75	80	85	90	95	00	05	10	11
286	433	676	849	1176	1396	1887	2311	2734	2909

Airline Miles - Freight (Worldwide, tons per year, in billions)

70	75	80	85	90	95	00	05	10	11
8	13	20	27	40	57	81	98	108	109

Source: International Civil Aviation Organization

Source: International Civil Aviation Organization

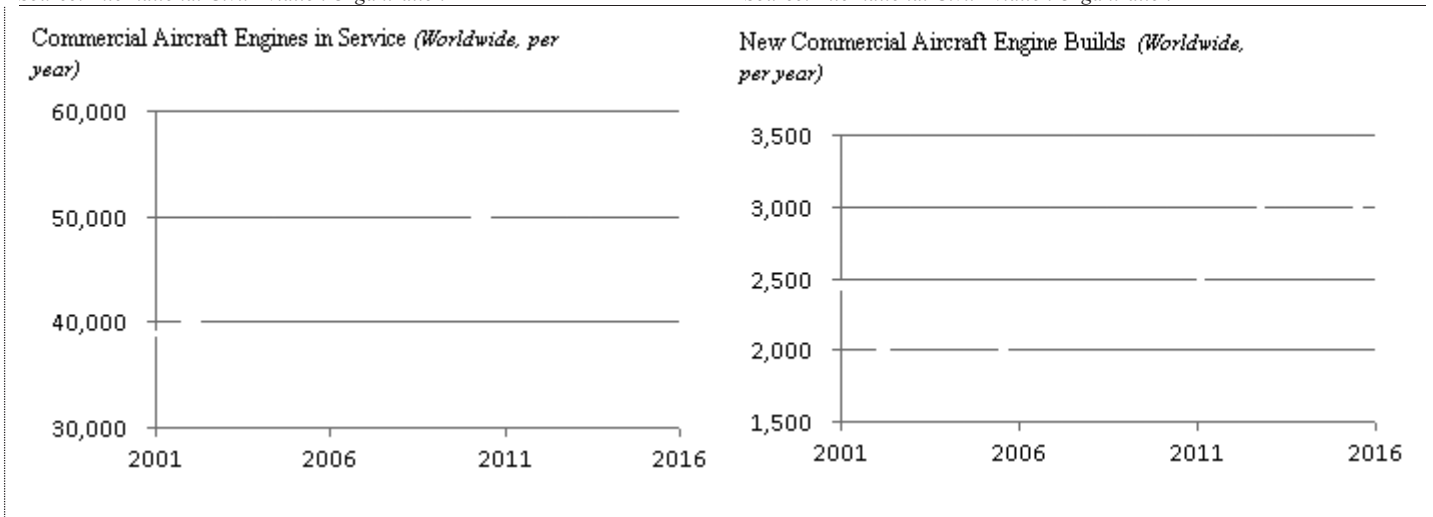

Commercial Aircraft Engines in Service (Worldwide, per year)

2001	2002	2003	2004	2005	2006	2007	2008	2009	2010	2011	2012	2013	2014	2015	2016
38,913	39,974	41,069	42,297	43,684	44,611	45,858	47,083	48,225	49,503	50,720	52,199	53,938	55,738	57,141	59,141

Source: Airline Monitor

New Commercial Aircraft Engine Builds (Worldwide, per year)

2001	2002	2003	2004	2005	2006	2007	2008	2009	2010	2011	2012	2013	2014	2015	2016
2,460	2,024	1,900	1,918	1,910	2,088	2,192	2,232	2,372	2,356	2,460	2,794	3,070	3,300	3,102	2,890

Source: Airline Monitor

### Commercial & Military Jet Aircraft Build Rate & Forecast

(Worldwide per year)

Forecast

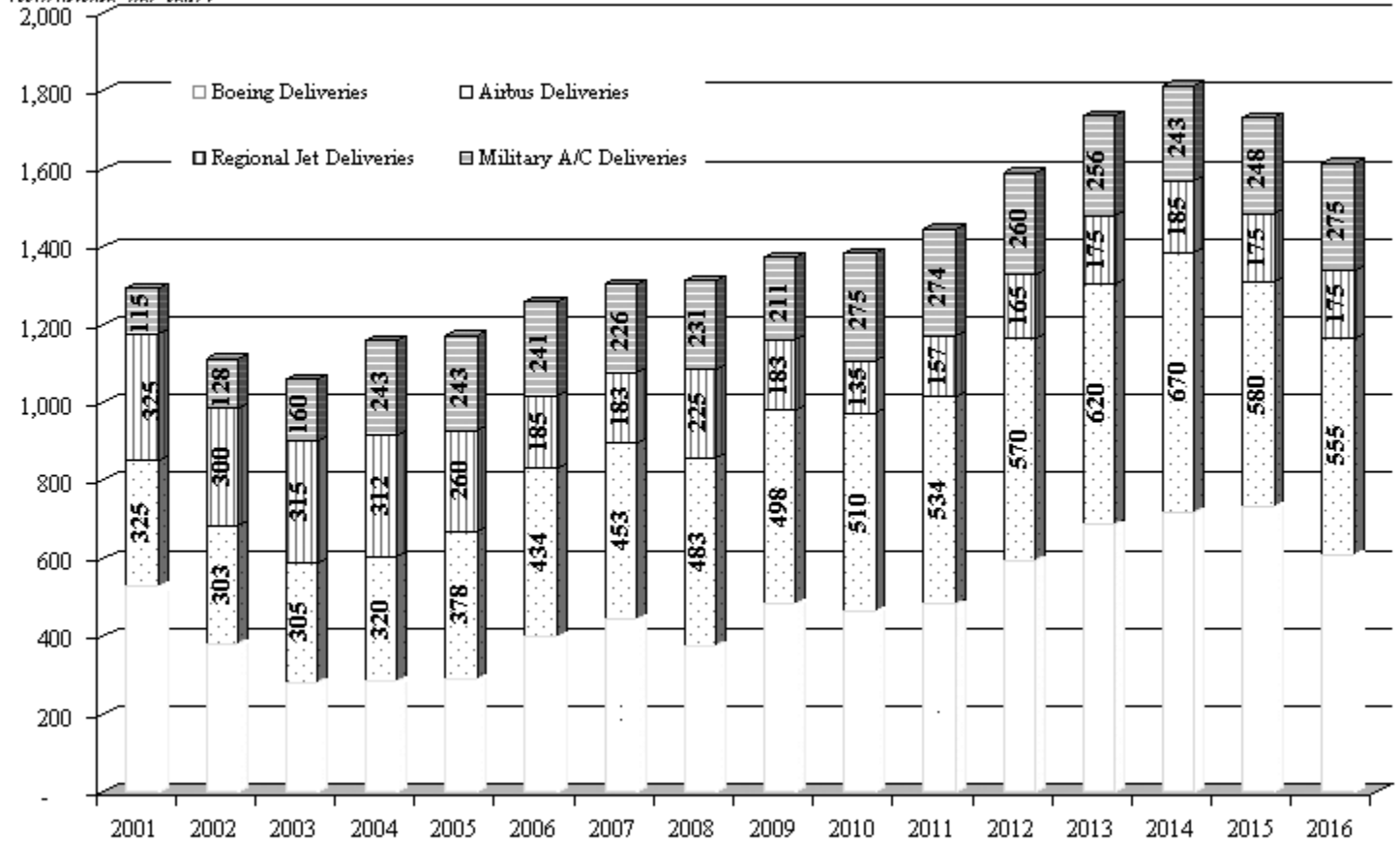

### Commercial & Military Jet Aircraft Build Rate and Forecast

Sources: Airline Monitor, Forecast International (Worldwide, per year)

	2001	2002	2003	2004	2005	2006	2007	2008	2009	2010	2011	2012	2013	2014	2015	2016
Boeing deliveries	527	381	281	285	290	398	441	375	481	462	481	595	685	715	730	610
Airbus deliveries	325	303	305	320	378	434	453	483	498	510	534	570	620	670	580	555
Regional Jet del.	325	300	315	312	260	185	183	225	183	135	157	165	175	185	175	175
Military A/C del.	115	128	160	243	243	241	226	231	211	275	274	260	256	243	248	275
Total deliveries	1,292	1,112	1,061	1,160	1,171	1,258	1,303	1,314	1,373	1,382	1,446	1,590	1,736	1,813	1,733	1,615

The Airline Monitor forecast (above) assumes a decline in single aisle deliveries in 2015 and 2016 as Airbus and Boeing transition to the new models, A320neo and 737MAX. According to Airline Monitor, "...it is the falloff in deliveries of the old types, not the ramp up rate of new models, that we see being mostly responsible for the decline in deliveries." This forecast differs with recent announcements by the OEMs. Even with the Airline Monitor assumption, the forecasted deliveries in 2015 and 2016 remain near historically high levels. Based on Airline Monitor data, the share of large twin aisle aircraft builds will grow from 4% of commercial aircraft builds in 2011 to more than 20% in 2016. The projected growth increase of large twin aisle aircraft builds is significant as these next generation large aircraft utilize significantly more of the high value types of materials we produce in both the airframe and in the engines.

Airline revenue passenger miles and freight miles increased 6.4% and 0.9%, respectively, in 2011 compared to 2010, continuing the growth trends of 8% and 19%, respectively, in 2010 compared to 2009, as business activity levels recovered from the global economic weakness experienced in 2008-2009. Since 2004, airline revenue passenger miles and freight miles have compound annual growth rates of 4.5% and 1.9%, respectively, according to the International Civil Aviation Organization (ICAO) data. Based on July 2011 forecasts, the ICAO expects growth of at least 6% annually, for several years, based on the demand for passenger and freight travel from developing economies, especially in Asia and the Middle East, and expected continuing economic growth in the rest of the

world. New commercial and military jet aircraft deliveries have increased 2.8% annually since 2005. Independent forecasts from both Airline Monitor and Forecast International project 2.2% compound growth of commercial and military jet aircraft deliveries for the next 5 years.

High Performance Metals segment operating profit for 2011 increased 41% to \$364.5 million compared to 2010, due primarily to higher shipments for most of our products, a favorable product mix, improved selling prices and the benefits of gross cost reductions. Operating profit in 2011 was impacted by \$27.3 million of inventory fair value adjustments associated with the Ladish transaction, and \$31.7 million of start-up and idle facility costs associated with our primary titanium sponge operations. Operating profit in 2010 included \$55.8 million of start-up and idle facility costs mainly involving the primary titanium sponge operations. The start-up costs relate mostly to our Rowley, UT premium-titanium sponge facility. This facility remains on track to complete the standard grade qualification by the end of the 2012 first quarter. With stable raw material input costs, higher production rates, and improved plant efficiencies, we expect to produce more titanium sponge at lower costs in 2012, compared to 2011, with a continued decline of start-up expenses for this facility of titanium and nickel-based and specialty steel alloys, which were partially offset by lower average selling prices for most of our products, lower exotic alloys shipment volume, and \$55.8 million for idle facility and start-up costs, mainly involving the primary titanium sponge operations.

Operating results for 2011 included a LIFO inventory valuation reserve charge of \$6.6 million, compared to a LIFO inventory valuation reserve benefit of \$16.3 million in 2010. We continued to aggressively reduce costs in 2011. Gross cost reductions, before the effects of inflation, totaled approximately \$63 million. Major areas of gross cost reductions included \$39 million from operating efficiencies and \$18 million from procurement savings.

### **2010 Compared to 2009**

Sales for the High Performance Metals segment for 2010 increased 3% to \$1.34 billion, due primarily to improved demand from the commercial aerospace jet engine market, as the supply chain adjusted to increasing aircraft production schedules and the aeroengine aftermarket improved as a result of increased flight activity. In addition, demand from the medical market for implants and imaging equipment increased by 36%. The improvement in these markets was partially offset by lower demand for our materials from the chemical processing and nuclear energy markets. Direct international sales as percentage of total segment sales were 32.8% for both periods.

Comparative information for our High Performance Metals segment revenues (in millions) by market, the respective percentages of overall segment revenues for the years ended 2010 and 2009, and the percentage change in revenues by market for 2010 is as follows:

Market	2010		2009		Change	
Aerospace:						
Jet Engines	\$ 393.5	29%	\$ 347.6	27%	\$ 45.9	13%
Airframes	277.3	21%	279.4	21%	(2.1)	(1%)
Government	104.8	8%	104.5	8%	0.3	0%
Total Aerospace	775.6	58%	731.5	56%	44.1	6%
Defense	104.0	8%	109.0	8%	(5.0)	(5%)
Oil & Gas/Chemical Process Industry	145.7	11%	163.2	13%	(17.5)	(11%)
Electrical Energy	95.2	7%	118.1	9%	(22.9)	(19%)
Medical	143.6	11%	105.4	8%	38.2	36%
Construction/Mining	2.2	0%	1.1	0%	1.1	100%
Other	71.2	5%	71.7	6%	(0.5)	(1%)
Total	\$ 1,337.5	100%	\$ 1,300.0	100%	\$ 37.5	3%

Shipment volumes increased for titanium mill products and nickel-based and specialty alloys, while average base selling prices for these products were lower as a result of a more competitive pricing environment. Comparative information on the segment's mill products for the years ended December 31, 2010 and 2009 is provided in the following table:

<i>For the Years Ended December 31,</i>	2010	2009	% Change
Mill Products Volume (000's pounds):			
Titanium	25,457	23,588	8%
Nickel-based and specialty alloys	37,272	32,562	14%
Exotic alloys	4,382	5,067	(14%)



Average prices (per pound):

Titanium	\$	19.37	\$	20.92	(7%)
Nickel-based and specialty alloys	\$	14.03	\$	14.43	(3%)
Exotic alloys	\$	60.68	\$	57.79	5%

High Performance Metals segment operating profit for 2010 increased 10% to \$257.8 million compared to 2009 primarily due to higher shipments of titanium and nickel-based and specialty steel alloys, which were partially offset by lower average selling prices for most of our products, lower exotic alloys shipment volume, and \$55.8 million for idle facility and start-up costs, mainly involving the titanium sponge operations. Results for 2010 and 2009 included LIFO inventory valuation reserve benefits of \$16.3 million and \$33.0 million, respectively.

We continued to aggressively reduce costs in 2010. Gross cost reductions, before the effects of inflation, totaled approximately \$68 million. Major areas of gross cost reductions included \$28 million from procurement savings, \$34 million from operating efficiencies, and \$6 million from reductions in compensation and benefit expenses.

**Flat-Rolled Products**

(In millions)

	2011	% Change	2010	% Change	2009
Sales to external customers	\$ 2,726.0	17%	\$ 2,338.5	54%	\$ 1,516.1
Operating profit	213.4	148%	85.9	20%	71.3
Operating profit as a percentage of sales	7.8%		3.7%		4.7%
Direct international sales as a percentage of sales	33.6%		32.4%		30.0%

Our Flat-Rolled Products segment produces, converts and distributes stainless steel, nickel-based alloys, specialty alloys, and titanium and titanium-based alloys, in a variety of product forms including plate, sheet, engineered strip, and Precision Rolled Strip products, as well as grain-oriented electrical steel sheet. The major end markets for our flat-rolled products are electrical energy, oil and gas, chemical processing, automotive, food processing equipment and appliances, construction and mining, electronics, communication equipment and computers, and aerospace and defense. The operations in this segment are ATI Allegheny Ludlum, our 60% interest in the Chinese joint venture company known as Shanghai STAL Precision Stainless Steel Company Limited (STAL), and our 50% interest in the industrial titanium joint venture known as Uniti LLC. The remaining 40% interest in STAL is owned by the Baosteel Group, a state authorized investment company whose equity securities are publicly traded in the People's Republic of China. The financial results of STAL are consolidated into the segment's operating results with the 40% interest of our minority partner recognized in the consolidated statement of income as net income attributable to noncontrolling interests. The remaining 50% interest in Uniti LLC is held by VSMPO, a Russian producer of titanium, aluminum, and specialty steel products. We account for the results of the Uniti joint venture using the equity method since we do not have a controlling interest.

**2011 Compared to 2010**

Sales for the Flat-Rolled Products segment for 2011 were \$2.73 billion, or 17% higher than 2010, due primarily to increased shipments and improved base-selling prices for most high-value products. Demand for these products was strong from the oil & gas and chemical process industry and aerospace markets, and improved from the global automotive market. Sales to the oil & gas and chemical process industry markets grew to 46% of sales, and direct international sales increased to 34% of sales. Comparative information for our Flat-Rolled Products segment revenues (in millions) by market, the respective percentages of overall segment revenues for the years ended 2011 and 2010, and the percentage change in revenues by market for 2011 is as follows:

Market	2011		2010		Change	
Oil & Gas/Chemical Process Industry	\$ 790.7	29%	\$ 542.7	23%	\$ 248.0	46%
Electrical Energy	564.4	21%	550.5	24%	13.9	3%
Automotive	346.4	13%	281.8	12%	64.6	23%
Food Equipment & Appliances	231.1	8%	268.9	11%	(37.8)	(14%)
Construction/Mining	216.3	8%	225.0	10%	(8.7)	(4%)
Aerospace & Defense	179.9	7%	116.4	5%	63.5	55%
Electronics/Computers/Communication	153.4	6%	117.1	5%	36.3	31%
Transportation	134.0	5%	112.5	5%	21.5	19%
Medical	61.4	2%	80.1	3%	(18.7)	(23%)
Other	48.4	1%	43.5	2%	4.9	11%
Total	\$ 2,726.0	100%	\$ 2,338.5	100%	\$ 387.5	17%

Total product shipments decreased 1% in 2011, as increased shipments and improved base-selling prices for most high-value products was offset by weak demand for standard stainless products. While average transaction prices for standard stainless products were higher on an annual basis compared to 2010, shipment volumes and average transaction prices declined sequentially, quarter over quarter, in 2011 due to lower demand, falling raw material surcharges and weak base-selling prices. Comparative information on the segment's products for the years ended December 31, 2011 and 2010 was:

<i>For the Years Ended December 31,</i>	2011	2010	% Change
<b>Volume (000's pounds):</b>			
High value	497,079	454,874	9%
Standard	587,648	642,255	(9%)
<b>Total Flat-Rolled Products</b>	<b>1,084,727</b>	<b>1,097,129</b>	<b>(1%)</b>
<b>Average prices (per pound):</b>			
High value	\$ 3.32	\$ 2.83	17%
Standard	\$ 1.80	\$ 1.62	11%
<b>Total Flat-Rolled Products</b>	<b>\$ 2.49</b>	<b>\$ 2.12</b>	<b>17%</b>

Our Flat-Rolled Products segment high-value product shipments, which include engineered strip, Precision Rolled Strip, super stainless steel, nickel-based alloys, specialty alloys, titanium, and grain-oriented electrical steel products, increased 9% in 2011 while average transaction prices for these high-value products increased 17%. Demand for our engineered strip and Precision Rolled Strip improved throughout 2011 as most markets continued to improve. Demand for our titanium products from the chemical process industry and oil and gas markets continued to increase, and shipments of titanium and ATI-produced UNITI titanium products increased over 50% in 2011 to almost 19 million pounds. Shipments of our grain-oriented electrical steel products, which are primarily sold under long-term supply agreements with key customers, continued to be affected by the downturn in residential and commercial construction.

Shipments of our standard products, which primarily include stainless steel hot roll and cold roll sheet, and stainless steel plate, decreased 9% while average transaction prices for these products increased by 11%. In 2011, consumption in the U.S. of stainless steel strip, sheet and plate products increased by 26%, compared to 2010 consumption, according to the Specialty Steel Institute of North America (SSINA), using annualized November 2011 information. The 2011 annual consumption of 1.58 million tons, although a return to 2007 levels, still reflects below average demand compared to historical periods. Industry reports show that the ferritic grade Type 409 accounted for the majority of U.S. consumption growth as the domestic auto market recovered.

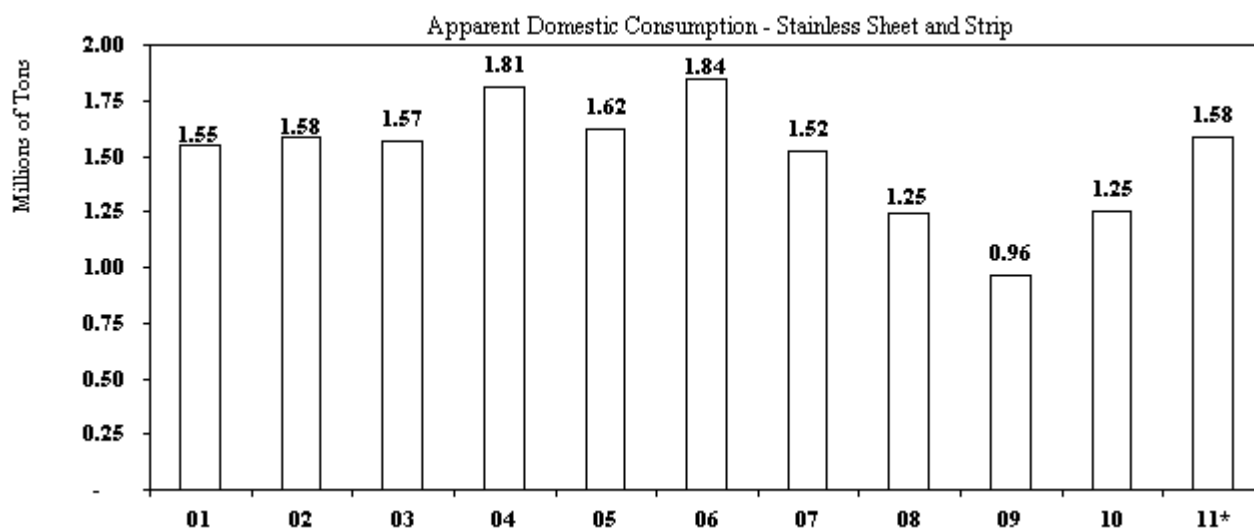

Source: SSINA

US ADC of Stainless Sheet and Strip (hot rolled and cold rolled)

	2001	2002	2003	2004	2005	2006	2007	2008	2009	2010	2011*
Millions of Tons	1.55	1.58	1.57	1.81	1.62	1.84	1.52	1.25	0.96	1.25	1.58

\* 2011 represents Nov YTD annualized

The majority of our flat-rolled products are sold at prices that include surcharges for raw materials, including purchased scrap, that are required to manufacture our products. These raw materials include nickel, iron, chromium, and molybdenum. Nickel, which comprises a significant percentage of our material costs, and where price is influenced by commodity exchange trading, continued to be volatile during 2011. The cost of nickel increased 17% during the first two months of 2011 to an average monthly cost of \$12.82 per pound in February 2011, only to decline throughout most of the year to a monthly average cost of \$8.11 per pound in November 2011, a 37% decline, ending the year with an average monthly cost of \$8.23 per pound in December 2011. Our other major raw materials were also volatile, with chromium and molybdenum both decreasing more than 15% during 2011. Volatility in raw material surcharges affects customer purchasing trends.

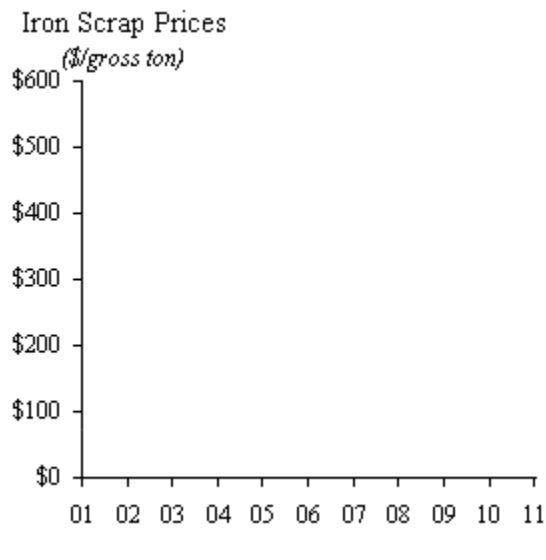
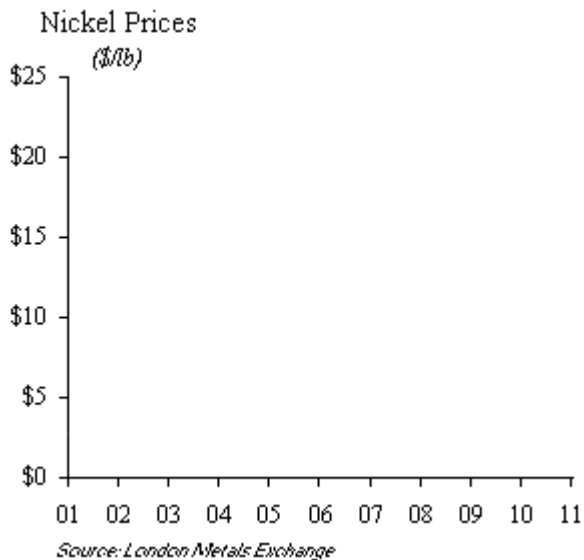

01	02	03	04	05	06	07	08	09	10	11
2.69	3.26	6.43	6.25	6.09	15.68	11.79	4.39	7.74	10.94	8.23

01	02	03	04	05	06	07	08	09	10	11
74	105	173	233	255	229	297	221	275	395	415

Source: London Metals Exchange

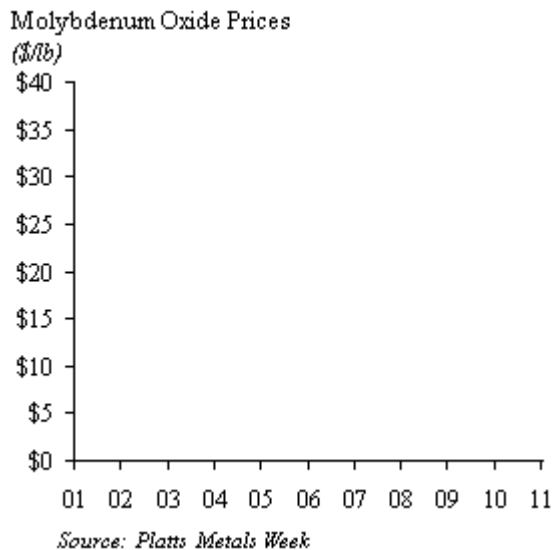
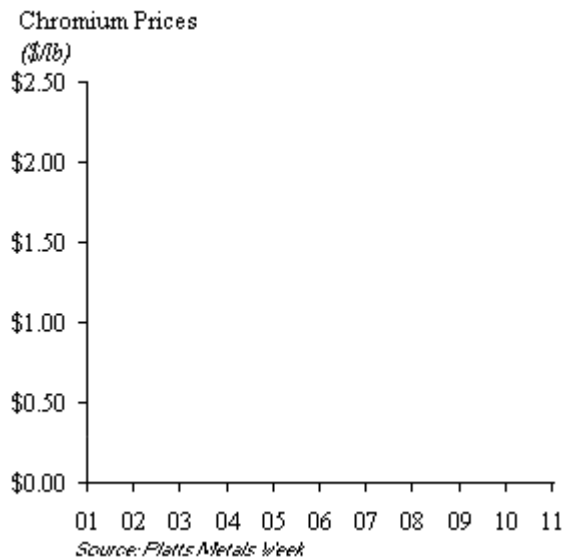

01	02	03	04	05	06	07	08	09	10	11
0.29	0.35	0.54	0.69	0.54	0.66	1.71	1.03	0.89	1.33	1.11

Source: Platts Metals Week

01	02	03	04	05	06	07	08	09	10	11
2.36	3.26	7.26	31.24	26.58	24.78	32.38	9.60	11.38	16.19	13.39

Source: Platts Metals Week

Segment operating profit was \$213.4 million, a 148% increase compared to 2010. The improvement in 2011 operating profit was due primarily to higher shipments of high value products, a better matching of raw material prices with surcharges, and the benefits of

our gross cost reduction efforts. Operating results for 2011 included a LIFO inventory valuation reserve benefit of \$34.7 million, compared to a LIFO inventory valuation reserve charge of \$70.7 million in 2010.

We continued to aggressively reduce costs and streamline our flat-rolled products operations. In 2011 we achieved gross cost reductions, before the effects of inflation, of approximately \$47 million in our Flat-Rolled Products segment. Major areas of gross cost reductions included \$25 million from operating efficiencies and \$18 million from procurement savings. In the fourth quarter 2011, we implemented plans to consolidate certain finishing operations in the Flat-Rolled Products segment, which resulted in \$2.6 million of restructuring charges, primarily related to severance and benefit costs associated with the temporary idling of the New Castle, IN sheet finishing facility.

### 2010 Compared to 2009

Sales for the Flat-Rolled Products segment for 2010 were \$2.34 billion, or 54% higher than 2009, due primarily to increased shipments, higher raw material surcharges, and improved base-selling prices for stainless products. Total product shipments increased 30% for 2010, as demand for high value and standard stainless products improved, and direct international sales continued to increase. Demand for our engineered strip and Precision Rolled Strip products improved throughout 2010 as most markets continued to improve. Demand for our titanium products from the chemical process industry and oil and gas markets rebounded from low 2009 levels, and shipments of titanium and ATI-produced UNITI titanium products increased 21% to approximately 12.5 million pounds in 2010. Shipments of grain-oriented electrical steel products, while negatively impacted by the downturn in residential and commercial construction, benefited from our long-term supply agreements with key customers. Comparative information for our Flat-Rolled Products segment revenues (in millions) by market, the respective percentages of overall segment revenues for the years ended 2010 and 2009, and the percentage change in revenues by market for 2010 is as follows:

Market	2010		2009		Change	
Oil & Gas/Chemical Process Industry	\$ 542.7	23%	\$ 354.2	23%	\$ 188.5	53%
Electrical Energy	550.5	24%	445.6	29%	104.9	24%
Automotive	281.8	12%	191.0	13%	90.8	48%
Food Equipment & Appliances	268.9	11%	170.6	11%	98.3	58%
Construction/Mining	225.0	10%	119.5	8%	105.5	88%
Aerospace & Defense	116.4	5%	87.7	6%	28.7	33%
Electronics/Computers/Communication	117.1	5%	77.5	5%	39.6	51%
Transportation	112.5	5%	38.3	3%	74.2	194%
Medical	80.1	3%	7.6	1%	72.5	954%
Other	43.5	2%	24.1	1%	19.4	80%
<b>Total</b>	<b>\$ 2,338.5</b>	<b>100%</b>	<b>\$ 1,516.1</b>	<b>100%</b>	<b>\$ 822.4</b>	<b>54%</b>

Total product shipments increased 30% for 2010, as demand for high value and standard stainless products improved. The average transaction prices to customers, which include the effect of raw material surcharges, increased by 20% in 2010, to \$2.12 per pound. Direct international sales as a percentage of total segment sales increased to 32.4% in 2010, compared to 30% in 2009. Sales of standard products, primarily stainless steel cold rolled sheet, represented the largest growth area of international sales. Comparative information on the segment's products for the years ended December 31, 2010 and 2009 is provided in the following table:

<i>For the Years Ended December 31,</i>	2010	2009	% Change
Volume (000's pounds):			
High value	454,874	367,195	24%
Standard	642,255	474,950	35%
<b>Total Flat-Rolled Products</b>	<b>1,097,129</b>	<b>842,145</b>	<b>30%</b>
Average prices (per pound):			
High value	\$ 2.83	\$ 2.49	14%
Standard	\$ 1.62	\$ 1.22	33%
<b>Total Flat-Rolled Products</b>	<b>\$ 2.12</b>	<b>\$ 1.77</b>	<b>20%</b>

The average transaction prices to customers, which include the effect of lower average raw material surcharges, decreased by 33% to \$1.77 per pound in 2009.

Operating income was \$85.9 million, a 20% increase compared to 2009. The improvements in 2010 operating profit was due primarily to increased shipments, higher average base selling prices for most of our products, \$14.3 million lower idle facility costs, and the benefits from our gross cost reduction efforts. These results were partially offset by a LIFO inventory valuation reserve charge of



\$70.7 million in 2010, due to significant increases in raw material costs. In 2009, Flat-Rolled Products segment results included a LIFO inventory valuation reserve benefit of \$60.8 million.

We continued to aggressively reduce costs and streamline our flat-rolled products operations. In 2010, we achieved gross cost reductions, before the effects of inflation, of approximately \$47 million in our Flat-Rolled Products segment. Major areas of gross cost reductions included \$40 million from procurement savings and operating efficiencies and \$7 million from reductions in compensation and benefit expenses.

### Engineered Products

<i>(In millions)</i>	2011	% Change	2010	% Change	2009
Sales to external customers	\$ 501.1	35%	\$ 371.8	56%	\$ 238.8
Operating profit (loss)	34.1	166%	12.8	154%	(23.8)
Operating profit (loss) as a percentage of sales	6.8%		3.4%		(10.0%)
Direct international sales as a percentage of sales	22.7%		23.6%		29.3%

Our Engineered Products segment includes the production of tungsten powder, tungsten heavy alloys, tungsten carbide materials and carbide cutting tools. The segment also produces carbon alloy steel impression die forgings, and large grey and ductile iron castings, and provides precision metals processing services. The operations in this segment are ATI Tungsten Materials, ATI Portland Forge, ATI Casting Service and ATI Precision Finishing.

The major markets served by our products of the Engineered Products segment include a wide variety of industrial markets including oil and gas, machine and cutting tools, transportation, construction and mining, electrical energy, aerospace and defense, and automotive.

#### 2011 Compared to 2010

Sales for the Engineered Products segment increased 35% to \$501.1 million in 2011 as demand continued to improve from the oil and gas, transportation, aerospace, electrical energy, and automotive markets, but remained weak from the wind energy market. Comparative information for our Engineered Products segment revenues (in millions) by market, the respective percentages of overall segment revenues for the years ended 2011 and 2010, and the percentage change in revenues by market for 2011 is as follows:

Market	2011		2010		Change	
Oil & Gas/Chemical Process Industry	\$ 136.2	27%	\$ 99.3	27%	\$ 36.9	37%
Machine & Cutting Tools	86.3	17%	65.9	18%	20.4	31%
Transportation	78.8	16%	51.8	14%	27.0	52%
Construction/Mining	69.2	14%	47.1	13%	22.1	47%
Aerospace & Defense	42.1	8%	31.6	8%	10.5	33%
Electrical Energy	37.0	8%	25.2	7%	11.8	47%
Automotive	30.7	6%	27.2	7%	3.5	13%
Medical	9.4	2%	10.8	3%	(1.4)	(13%)
Other	11.4	2%	12.9	3%	(1.5)	(12%)
Total	\$ 501.1	100%	\$ 371.8	100%	\$ 129.3	35%

The improved demand and better pricing for most products resulted in operating profit of \$34.1 million for 2011, a significant increase over 2010 operating profit of \$12.8 million. Operating results were impacted by idle facility costs of \$2.4 million for 2011 and \$2.7 million in 2010. Results included a LIFO inventory valuation reserve charge of \$18.8 million in 2011, due primarily to higher tungsten raw material costs. Operating results in 2010 included a LIFO inventory valuation reserve charge of \$5.8 million due to higher raw material costs.

In 2011, we achieved gross cost reductions, before the effects of inflation, of approximately \$14 million in our Engineered Products segment. Major areas of gross cost reductions included \$11 million from procurement savings and operating efficiencies, and \$3 million from lower compensation and benefit expenses.

#### 2010 Compared to 2009

Sales for the Engineered Products segment increased 56% to \$371.8 million in 2010 as demand continued to improve from the oil and gas, transportation, aerospace, electrical energy, and automotive markets, but remained weak from the wind energy market.

Comparative information for our Engineered Products segment revenues (in millions) by market, the respective percentages of overall segment revenues for the years ended 2010 and 2009, and the percentage change in revenues by market for 2010 is as follows:

Market	2010		2009		Change	
Oil & Gas/Chemical Process Industry	\$ 99.3	27%	\$ 64.2	27%	\$ 35.1	55%
Machine & Cutting Tools	65.9	18%	42.2	18%	23.7	56%
Transportation	51.8	14%	31.2	13%	20.6	66%
Construction/Mining	47.1	13%	27.4	11%	19.7	72%
Aerospace & Defense	31.6	8%	17.1	7%	14.5	85%
Automotive	27.2	7%	15.6	7%	11.6	74%
Electrical Energy	25.2	7%	12.6	5%	12.6	100%
Medical	10.8	3%	9.6	4%	1.2	13%
Other	12.9	3%	18.9	8%	(6.0)	(32%)
<b>Total</b>	<b>\$ 371.8</b>	<b>100%</b>	<b>\$ 238.8</b>	<b>100%</b>	<b>\$ 133.0</b>	<b>56%</b>

The improved demand and better pricing for most products resulted in operating profit of \$12.8 million for 2010, compared to an operating loss of \$23.8 million for 2009. Operating results were impacted by idle facility costs of \$2.7 million for 2010. Results for 2010 included a LIFO inventory valuation reserve charge of \$5.8 million due to higher raw material costs. In 2009, the operating loss included idle facility and workforce reduction costs of \$5.7 million, and was partially offset by a LIFO benefit of \$9.0 million primarily as a result of lower raw material costs.

In 2010, we achieved gross cost reductions, before the effects of inflation, of approximately \$20 million in our Engineered Products segment. Major areas of gross cost reductions included \$13 million from procurement savings and operating efficiencies, and \$7 million from lower compensation and benefit expenses.

### Corporate Expenses

Corporate expenses were \$92.5 million in 2011 compared to \$64.1 million in 2010, and \$53.1 million in 2009. The increase in corporate expenses in 2011 was primarily the result of annual and long-term performance based compensation expenses, including the accelerated recognition of equity compensation due to executive retirements. Additionally, the increase in corporate expenses in 2011 compared to 2010 was due to Ladish acquisition expenses and higher corporate funded R&D costs. The increase in corporate expense in 2010 compared to 2009 was due to corporate funded R&D, Ladish acquisition expenses, and higher incentive based compensation expenses.

### Interest Expense, Net

Interest expense, net of interest income and interest capitalization, was \$92.3 million in 2011, \$62.7 million for 2010 and \$19.3 million for 2009. The increase in interest expense in 2011 was primarily due to the January 7, 2011 issuance of \$500 million of 5.95% Notes due 2021, and debt assumed in the Ladish acquisition. The increase in interest expense in 2010 was due to lower capitalized interest on strategic projects as a result of project completions as well as the full year of interest costs associated with the debt issuances completed in the 2009 second quarter. Interest expense is presented net of interest income of \$1.4 million for 2011, \$1.1 million for 2010, and \$2.1 million for 2009.

Capital expenditures associated with strategic investments to expand our production capabilities resulted in interest capitalization in 2011, 2010 and 2009. Interest expense in 2011, 2010, and 2009 was reduced by \$12.1 million, \$12.5 million, and \$39.0 million, respectively, related to interest capitalization on major strategic capital projects.

In prior years, we entered into “receive fixed, pay floating” interest rate swap contracts related to our \$300 million, 8.375% 10-year Notes due in 2011 (“2011 Notes”), which were later settled, resulting in a gain. The settlement gain was amortized into income as an offset to interest expense over the remaining life of the 2011 Notes, which matured in December 2011. Interest expense decreased by \$0.9 million in both 2011 and 2010, and \$1.3 million in 2009 due to these previously settled interest rate swap agreements.

In June 2009, we completed the issuance of \$350 million of 9.375% 10-year Senior Notes and a tender offer for the 2011 Notes. As a result of the tender offer, in June 2009 we retired \$183.3 million of the 2011 Notes, which resulted in a special charge for debt extinguishment of \$9.2 million pre-tax, or \$5.5 million after-tax, in the second quarter 2009.

## Other Expenses, Net of Gains on Asset Sales

Other expenses, net of gains on asset sales, includes charges incurred in connection with closed operations, pre-tax gains and losses on the sale of surplus real estate, non-strategic investments and other assets, and other non-operating income or expense. These items are presented primarily in selling and administrative expenses, and in other income in the consolidated statements of income and resulted in net charges of \$9.9 million in 2011, \$13.9 million in 2010, and \$13.8 million in 2009. Other expenses for 2011, 2010, and 2009 primarily related to legal costs associated with closed operations.

## Retirement Benefit Expense

Retirement benefit expense, which includes pension and postretirement medical benefits, declined year over year in both 2011 and 2010. The decreases in 2011 and 2010 were primarily due to higher than expected returns on pension plan assets and the benefits resulting from our voluntary pension contributions made over the past several years. Over the past seven years, we have made over \$765 million of voluntary pension contributions to our U.S. qualified defined benefit pension plan, including \$350 million in the second quarter of 2009. Retirement benefit expense was \$77.9 million in 2011, \$90.1 million for 2010, and \$121.9 million for 2009. Retirement benefit expenses are included in both cost of sales and selling and administrative expenses. Retirement benefit expense included in cost of sales and selling and administrative expenses for the years ended 2011, 2010, and 2009 was as follows:

<i>(In millions)</i>	2011	2010	2009
Cost of sales	\$ 55.1	\$ 64.6	\$ 85.4
Selling and administrative expenses	22.8	25.5	36.5
Total retirement benefit expense	\$ 77.9	\$ 90.1	\$ 121.9

Total retirement benefit expense for 2012 is expected to increase to approximately \$122 million, a \$44 million increase from 2011. We expect pension expense to be approximately \$98 million, an increase of \$40.6 million compared to pension expense of \$57.4 million in 2011. This expected increase is primarily a result of utilizing a lower discount rate to value the plan's obligations and lower than expected returns on pension plan assets for 2011.

## Income Taxes

Net income for 2011 included a provision for income taxes of \$116.3 million, or 34.3% of income before tax, for U.S. Federal, foreign and state income taxes. The 2010 provision for income taxes was \$47.0 million, or 37.4% of income before tax, for U.S. Federal, foreign and state income taxes. The 2010 provision for income taxes included a non-recurring charge of \$5.3 million related to the Patient Protection and Affordable Care Act. Under this legislation, the tax advantage of the subsidy to encourage companies to provide retiree prescription drug coverage was eliminated. Although the elimination of this tax advantage under the new legislation does not take effect until 2013, the Company was required by U.S. generally accepted accounting principles to recognize the full accounting impact in the period in which the Act became law. Since future anticipated retiree health care liabilities and related tax subsidies were already reflected in ATI's financial statements, the change in law resulted in a reduction of the value of the Company's deferred tax asset related to the subsidy. Results of operations for 2010 also included a tax charge of \$3.9 million primarily due to the Small Business Jobs and Credit Act, which allowed businesses of all sizes to accelerate depreciation on certain property placed into service during 2010, which increased the Company's ability to recover prior years' cash taxes paid, but reduced the current year tax benefit of the manufacturing deduction. Net income for 2009 included a provision for income taxes of \$26.9 million, or 41.4% of income before tax, for U.S. Federal, foreign and state income taxes. The 2009 provision for income taxes included a non-recurring charge of \$11.5 million recognized in the second quarter 2009 primarily associated with the tax consequences of the June 2009 \$350 million voluntary cash contribution to our pension plan.

Deferred taxes result from temporary differences in the recognition of income and expense for financial and income tax reporting purposes, and differences between the fair value of assets acquired in business combinations accounted for as purchases for financial reporting purposes and their corresponding tax bases. Deferred income taxes represent future tax benefits or costs to be recognized when those temporary differences reverse. At December 31, 2011, we had a net deferred tax liability of \$33.3 million.

## Financial Condition and Liquidity

We believe that internally generated funds, current cash on hand, and available borrowings under our existing credit facilities will be adequate to meet foreseeable liquidity needs, including a substantial expansion of our production capabilities over the next few years.

We did not borrow funds under our domestic senior unsecured credit facility during 2011, 2010, or 2009. However, as of December 31, 2011 approximately \$7 million of this facility was utilized to support letters of credit.

If we needed to obtain additional financing using the credit markets, the cost and the terms and conditions of such borrowings may be influenced by our credit rating. Changes in our credit rating do not impact our access to, or the cost of, our existing credit facilities.

We have no off-balance sheet arrangements as defined in Item 303(a)(4) of SEC Regulation S-K.

### Cash Flow and Working Capital

Cash flow from operations for 2011 was \$296.8 million, as improved profitability was partially offset by an investment in managed working capital of \$273.3 million, primarily due to a significant increase in the level of business activity. Cash used in investing activities was \$624.7 million, including \$349.2 million for the purchase of Ladish, net of cash acquired, and \$278.2 in capital expenditures. Cash provided by financing activities was \$276.2 million in 2011, primarily due to issuance of \$500.0 million of 5.95% Senior notes, partially offset by debt retirements of \$146.9 million, including the remaining \$117 million of 8.375% Notes which matured in December 2011, and dividend payments to ATI stockholders of \$74.7 million. At December 31, 2011, cash and cash equivalents on hand totaled \$380.6 million, a decrease of \$51.7 million from year end 2010. Cash and cash equivalents held by our foreign subsidiaries was \$116.0 million at December 31, 2011.

Cash flow from operations for 2010 was \$27.1 million, as an investment in managed working capital of \$318.5 million to support increased business activity and higher raw material costs offset improved profitability. During 2010, we invested \$219.1 in capital expenditures. Cash used in financing activities was \$86.8 million in 2010, primarily due to dividend payments of \$70.8 million. At December 31, 2010, cash and cash equivalents on hand totaled \$432.3 million, a decrease of \$276.5 million from year end 2009.

### Managed Working Capital

As part of managing the liquidity of the business, we focus on controlling inventory, accounts receivable and accounts payable. In measuring performance in controlling this managed working capital, we exclude the effects of LIFO inventory valuation reserves, excess and obsolete inventory reserves, and reserves for uncollectible accounts receivable which, due to their nature, are managed separately. We also measure managed working capital as a percentage of the prior two months annualized sales to evaluate our performance based on recent levels of business volume.

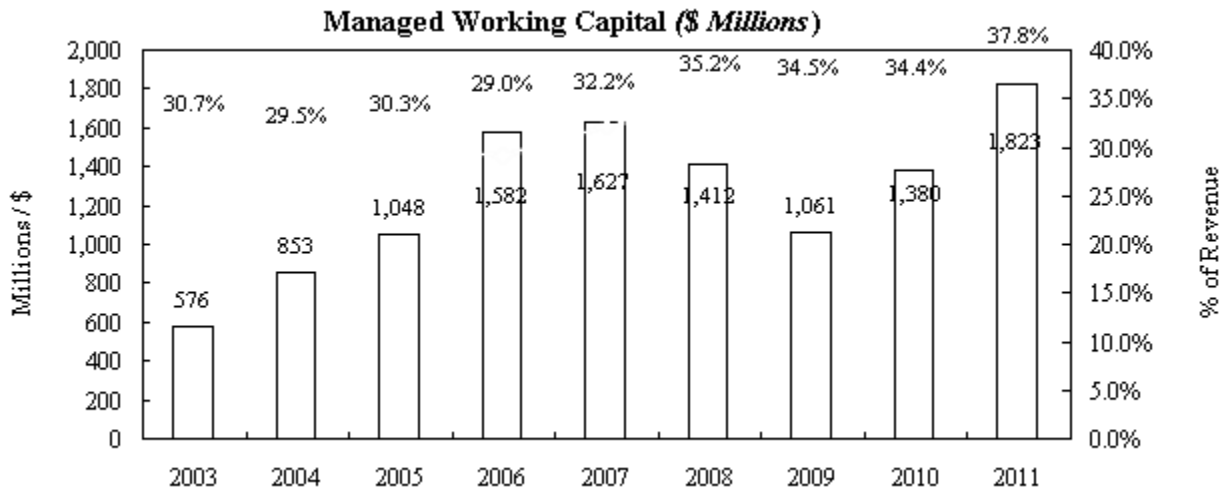

	03	04	05	06	07	08	09	10	11
Millions/\$	576	853	1,048	1,582	1,627	1,412	1,061	1,380	1,823
% of Annualized Revenue	30.7%	29.5%	30.3%	29.0%	32.2%	35.2%	34.5%	34.4%	37.8%

In 2011, managed working capital, which we define as gross inventory plus gross accounts receivable less accounts payable, increased by \$273.3 million, after adjustments for working capital acquired in the Ladish acquisition, due to increased business activity. The increase in managed working capital was a use of cash in 2011, as gross inventory increased \$244.9 million and accounts receivable increased \$79.8 million, partially offset by an increase in accounts payable of \$51.4 million.

In 2010, managed working capital increased by \$318.5 million due to increased business activity and increased costs for certain raw materials. The increase in managed working capital was a use of cash in 2010, as gross inventory increased \$250.8 million and accounts receivable increased \$152.5 million, partially offset by an increase in accounts payable of \$84.8 million.



Managed working capital as a percentage of sales has increased from historical levels due to a continuing shift in mix to more value added products, primarily in the High Performance Metals and Flat-Rolled Products business segments, which have a longer manufacturing process. Days sales outstanding, which measures actual collection timing for accounts receivable, increased in 2011 compared to 2010 primarily as a result of increased international sales which have longer collection cycles. Gross inventory turns, which excludes the effect of LIFO inventory valuation reserves, decreased slightly at year-end 2011.

The Components of managed working capital were as follows:

<i>(in millions)</i>	<b>December 31, 2011</b>	December 31, 2010	December 31, 2009
Accounts receivable	\$ 709.1	\$ 545.4	\$ 392.0
Inventory	1,384.3	1,024.5	825.5
Accounts payable	(490.7)	(394.1)	(308.6)
Subtotal	1,602.7	1,175.8	908.9
Allowance for doubtful accounts	5.9	5.6	6.5
LIFO reserve	153.7	163.0	102.8
Corporate and other	60.9	35.3	43.0
Managed working capital	\$ 1,823.2	\$ 1,379.7	\$ 1,061.2
Annualized prior 2 months sales	\$ 4,820.6	\$ 4,007.7	\$ 3,076.4
Managed working capital as a % of annualized sales	37.8%	34.4%	34.5%
December 2011 change in managed working capital	\$ 443.5		
Managed working capital acquired	(170.2)		
Net change in managed working capital	\$ 273.3		

#### Capital Expenditures and Acquisitions

Capital expenditures, for 2011 were \$278.2 million, compared to \$219.1 million in 2010, and \$415.4 million in 2009. Since 2004, we have transformed ATI by investing over \$3.3 billion in capital expenditures and acquisitions, including \$1.2 billion in 2011. Virtually all of these investments have been in the United States and more than 75% has been self-funded.

We have significantly expanded and continue to expand our manufacturing capabilities to meet current and expected demand growth from the aerospace (engine and airframe) and defense, oil and gas, chemical process industry, electrical energy, and medical markets, especially for titanium and titanium-based alloys, nickel-based alloys and superalloys, specialty alloys, and exotic alloys. Significant capital expenditures completed or in progress include:

- The expansion of ATI's aerospace quality titanium sponge production capabilities. Titanium sponge is an important raw material used to produce our titanium mill products. Our greenfield premium-grade titanium sponge (jet engine rotating parts) facility in Rowley, UT, with a total cost of approximately \$500 million, continued to ramp up production during 2011, and we expect to complete the standard grade qualification process by the end of the first quarter 2012, to be followed by premium grade qualification. When this Utah sponge facility is fully operational, our total annual sponge production capacity, including our Albany, OR standard grade titanium sponge facility, is projected to be approximately 46 million pounds. These secure supply sources are intended to reduce our purchased titanium sponge and purchased titanium scrap requirements. In addition, the Utah facility will have the infrastructure in place to further expand annual capacity by approximately 18 million pounds, bringing the total annual capacity at that facility to 42 million pounds, if needed.
- The design and construction of a new advanced specialty metals hot-rolling and processing facility at our existing Flat-Rolled Products segment Brackenridge, PA site for approximately \$1.1 billion. The facility construction is progressing on schedule, with construction expected to be completed by the end of 2013 and commissioning occurring in the first half of 2014. The new hot-rolling and processing facility is designed to be the most powerful mill in the world for production of specialty metals. It is designed to produce exceptional quality, thinner, and wider hot-rolled coils at reduced cost with shorter lead times, and require lower working capital requirements. When completed, we believe ATI's new hot-rolling and processing facility will provide unsurpassed manufacturing capability and versatility in the production of a wide range of flat-rolled specialty metals. We expect improved productivity, lower costs, and higher quality for our diversified product mix of flat-rolled specialty metals, including nickel-based and specialty alloys, titanium and titanium alloys, zirconium alloys, Precision Rolled Strip<sup>®</sup> products, and stainless sheet and coiled plate products. It is designed to roll and process exceptional quality hot bands of up to 78.62 inches, or 2 meters, wide.

- The expansion of our High Performance Metals segment production capabilities in North Carolina. Our fourth cold-hearth plasma arc melt (PAM) furnace for melting premium titanium alloys is in the qualification stage and is expected to support our growth in demand for high-value products in 2012. The PAM furnace is a superior cold-hearth melting process for making alloyed premium titanium products for jet engine rotating parts, medical applications, and other critical applications. Our titanium alloys and nickel-based alloys and superalloys forging facility, which was constructed in phases through 2009 and is now fully in service, includes a new 10,000 ton press forge and a new 700mm radial forge, both of which we believe are the largest of their kind in the world for producing these types of alloys. The facility also includes billet conditioning and finishing equipment.
- In May 2011, ATI completed the acquisition of Ladish Co., Inc. for \$897.6 million, comprised of the issuance of 7.3 million shares of ATI common stock and payment of \$384 million in cash. Based in Wisconsin, ATI Ladish engineers, produces and markets high-strength, high technology forged and cast metal components for a wide variety of load-bearing and fatigue-resisting applications in the jet engine, aerospace and industrial markets, for both domestic and international customers.

We currently expect that our 2012 capital expenditures to be approximately \$485 million all of which we expect to fund from operating cash flow and available cash on hand.

### Debt

Total debt outstanding increased by \$446.0 million, to \$1,509.3 million at December 31, 2011, from \$1,063.3 million at December 31, 2010. The increase was primarily due to the issuance of \$500 million of 5.95% Notes due 2021. Additionally, \$84.3 million of indebtedness was assumed in the Ladish acquisition. These amounts were offset by the retirement of \$117.0 million of 2011 Notes in December of 2011. In managing our overall capital structure, some of the measures on which we focus are net debt to total capitalization, which is the percentage of our debt, net of cash that may be available to reduce borrowings, to our total invested and borrowed capital, and total debt to total capitalization, which excludes cash balances. At year-end 2011, our net debt to total capitalization was 31.3%, compared to 23.6% at December 31, 2010, and 15.3% at December 31, 2009. Total debt to total capitalization was 37.9% at December 31, 2011 compared to 34.3% at December 31, 2010, and 34.7% at December 31, 2009.

<i>(In millions)</i>	<b>December 31, 2011</b>	December 31, 2010
Total debt	\$ 1,509.3	\$ 1,063.3
Less: Cash	(380.6)	(432.3)
Net debt	\$ 1,128.7	\$ 631.0
Net debt	\$ 1,128.7	\$ 631.0
Total ATI stockholders' equity	2,475.3	2,040.8
Net ATI capital	\$ 3,604.0	\$ 2,671.8
Net debt to ATI capital	31.3%	23.6%

<i>(In millions)</i>	<b>December 31, 2011</b>	December 31, 2010
Total debt	\$ 1,509.3	\$ 1,063.3
Total ATI stockholders' equity	2,475.3	2,040.8
Total ATI capital	\$ 3,984.6	\$ 3,104.1
Total debt to ATI capital	37.9%	34.3%

We have a \$400 million senior unsecured domestic revolving credit facility that expires in December 2015. The facility includes a \$200 million sublimit for the issuance of letters of credit. Under the terms of the facility, we may increase the size of the credit facility by up to \$100 million without seeking the further approval of the lending group. The facility requires us to maintain a leverage ratio (consolidated total indebtedness divided by consolidated earnings before interest, taxes and depreciation and amortization) of not greater than 3.25, and maintain an interest coverage ratio (consolidated earnings before interest and taxes divided by interest expense) of not less than 2.0. At December 31, 2011, our leverage ratio was 1.78 and our interest coverage ratio was 5.31. The definition of consolidated earnings before interest and taxes, and consolidated earnings before income, taxes, depreciation and amortization as used in the interest coverage and leverage ratios excludes any non-cash pension expense or income, and consolidated indebtedness in the leverage ratio is net of cash on hand in excess of \$50 million. We were in compliance with these required ratios during all applicable periods. As of December 31, 2011, there had been no borrowings made under the facility, although a portion of the facility was used to support approximately \$7 million in letters of credit.

We have an additional, separate credit facility for the issuance of letters of credit. As of December 31, 2011, \$31 million in letters of credit were outstanding under this facility.

STAL, our Chinese joint venture company in which ATI has a 60% interest, has a revolving credit facility with a group of banks which extends through early August 2012. Under the credit facility, STAL may borrow up to 205 million renminbi (approximately \$32 million at December 2011 exchange rates) at an interest rate equal to 90% of the applicable lending rate published by the People's Bank of China. The credit facility is supported solely by STAL's financial capability without any guarantees from the joint venture partners, and is intended to be utilized in the future for the expansion of STAL's operations, which are located in Shanghai, China. The credit facility requires STAL to maintain a minimum level of shareholders' equity, and certain financial ratios. As of December 31, 2011, there had been no borrowings made under this credit facility.

A summary of required payments under financial instruments (excluding accrued interest) and other commitments are presented below.

<i>(In millions)</i>	Total	Less than 1 year	1-3 years	4-5 years	After 5 years
<b>Contractual Cash Obligations</b>					
Total Debt including Capital Leases (A)	\$ 1,501.5	\$ 27.3	\$ 450.0	\$ 23.9	\$ 1,000.3
Operating Lease Obligations	87.4	17.0	25.5	15.6	29.3
Other Long-term Liabilities (B)	124.7	-	51.3	11.4	62.0
<b>Unconditional Purchase Obligations</b>					
Raw Materials (C)	1,133.1	538.6	361.2	61.6	171.7
Capital expenditures	529.6	214.3	302.8	12.5	-
Other (D)	211.5	69.3	89.0	34.0	19.2
<b>Total</b>	<b>\$ 3,587.8</b>	<b>\$ 866.5</b>	<b>\$ 1,279.8</b>	<b>\$ 159.0</b>	<b>\$ 1,282.5</b>
<b>Other Financial Commitments</b>					
Lines of Credit (E)	\$ 534.5	\$ 75.6	\$ 58.9	\$ 400.0	\$ -
Guarantees	\$ 19.4				

(A) Debt and capital leases exclude acquisition fair value adjustments.

(B) Other long-term liabilities exclude pension liabilities and accrued postretirement benefits. See Note 10. Pension Plans and Other Postretirement Benefits of the notes to the 2011 consolidated financial statements for further information on these obligations.

(C) We have contracted for physical delivery for certain of our raw materials to meet a portion of our needs. These contracts are based upon fixed or variable price provisions. We used current market prices as of December 31, 2011, for raw material obligations with variable pricing.

(D) We have various contractual obligations that extend through 2016 for services involving production facilities and administrative operations. Our purchase obligation as disclosed represents the estimated termination fees payable if we were to exit these contracts.

(E) Drawn amounts were \$24.5 million at December 31, 2011 under foreign credit agreements, and drawn amounts are included in total debt. Drawn amounts also include \$6.8 million utilized under the \$400 million domestic senior unsecured credit facility for standby letters of credit, which renew annually, and \$31.0 million under a separate letter of credit facility. These letters of credit are used to support: \$29.0 million in workers' compensation and general insurance arrangements, and \$8.8 million related to environmental, legal and other matters.

### **Retirement Benefits**

At December 31, 2011, our U.S. qualified defined benefit pension plan (U.S. Plan) was approximately 84% funded. In December 2011, the qualified defined benefit plans of ATI Ladish were merged into the U.S. Plan. The funded position of the U.S. Plan declined in 2011 primarily due to the use of a lower discount rate to value plan liabilities, and also due to lower than expected returns on plan assets. We have not been required to make cash contributions to the U.S. Plan since 1995, and we did not make a contribution during 2011. However, during the years of 2004-2009, we made \$765.2 million in voluntary cash and stock contributions to this plan to improve the plan's funded position. These voluntary contributions were comprised of cash contributions of \$350 million in 2009, \$30 million in 2008, and \$100 million during each of 2007, 2006 and 2005, respectively, plus \$50 million during 2004. Additionally in the fourth quarter of 2008, we contributed 1.5 million shares of ATI common stock, valued at \$35.2 million, to the pension plan. Based on current regulations and actuarial studies, we do not expect to be required to make cash contributions to our U.S. Plan for 2012.

However, we may elect, depending upon investment performance of the pension plan assets and other factors, to make additional voluntary cash contributions to this pension plan in the future.

We fund certain retiree health care benefits for Allegheny Ludlum using investments held in a Company-administered Voluntary Employee Benefit Association (VEBA) trust. This allows us the opportunity to generate investment returns to recover a portion of the retiree medical costs. In accordance with our labor agreements, during 2011, 2010, and 2009, we funded \$5.2 million, \$4.2 million, and \$13.8 million, respectively, of retiree medical costs using the investments of this VEBA trust. We may continue to fund certain retiree medical benefits utilizing the investments held in this VEBA. The value of the investments held in this VEBA was approximately \$9 million as of December 31, 2011.

### ***Dividends***

We paid a quarterly dividend of \$0.18 per share of common stock for each quarter of 2011 and 2010. The payment of dividends and the amount of such dividends depends upon matters deemed relevant by our Board of Directors, such as our results of operations, financial condition, cash requirements, future prospects, any limitations imposed by law, credit agreements or senior securities, and other factors deemed relevant and appropriate.

### **Critical Accounting Policies**

The accompanying consolidated financial statements have been prepared in conformity with United States generally accepted accounting principles. When more than one accounting principle, or the method of its application, is generally accepted, management selects the principle or method that is appropriate in our specific circumstances. Application of these accounting principles requires our management to make estimates about the future resolution of existing uncertainties; as a result, actual results could differ from these estimates. In preparing these financial statements, management has made its best estimates and judgments of the amounts and disclosures included in the financial statements giving due regard to materiality.

### ***Inventories***

At December 31, 2011, we had net inventory of \$1,384.3 million. Inventories are stated at the lower of cost (last-in, first-out (LIFO), first-in, first-out (FIFO) and average cost methods) or market, less progress payments. Costs include direct material, direct labor and applicable manufacturing and engineering overhead, and other direct costs. Most of our inventory is valued utilizing the LIFO costing methodology. Inventory of our non-U.S. operations is valued using average cost or FIFO methods. Under the LIFO inventory valuation method, changes in the cost of raw materials and production activities are recognized in cost of sales in the current period even though these material and other costs may have been incurred at significantly different values due to the length of time of our production cycle. The prices for many of the raw materials we use have been extremely volatile during the past four years. Since we value most of our inventory utilizing the LIFO inventory costing methodology, a rise in raw material costs has a negative effect on our operating results, while, conversely, a fall in material costs results in a benefit to operating results. For example, in 2011, the effect of falling raw material costs on our LIFO inventory valuation method resulted in cost of sales which were \$9.3 million lower than would have been recognized had we utilized the FIFO methodology to value our inventory. Conversely, in 2010, the effect of rising raw material costs on our LIFO inventory valuation method resulted in cost of sales which were \$60.2 million higher than would have been recognized had we utilized the FIFO methodology to value our inventory. In 2009, the effect of falling raw material costs on our LIFO inventory valuation method resulted in cost of sales which were \$102.8 million lower than would have been recognized had we utilized the FIFO methodology to value our inventory. In a period of rising prices, cost of sales expense recognized under LIFO is generally higher than the cash costs incurred to acquire the inventory sold. Conversely, in a period of declining raw material prices, cost of sales recognized under LIFO is generally lower than cash costs incurred to acquire the inventory sold.

The LIFO inventory valuation methodology is not utilized by many of the companies with which we compete, including foreign competitors. As such, our results of operations may not be comparable to those of our competitors during periods of volatile material costs due, in part, to the differences between the LIFO inventory valuation method and other acceptable inventory valuation methods.

We evaluate product lines on a quarterly basis to identify inventory values that exceed estimated net realizable value. The calculation of a resulting reserve, if any, is recognized as an expense in the period that the need for the reserve is identified. At December 31, 2011, no significant reserves were required. It is our general policy to write-down to scrap value any inventory that is identified as obsolete and any inventory that has aged or has not moved in more than twelve months. In some instances this criterion is up to twenty-four months due to the longer manufacturing and distribution process for such products.

### ***Asset Impairment***

We monitor the recoverability of the carrying value of our long-lived assets. An impairment charge is recognized when the expected net undiscounted future cash flows from an asset's use (including any proceeds from disposition) are less than the asset's carrying value, and the asset's carrying value exceeds its fair value. Changes in the expected use of a long-lived asset group, and the financial performance of the long-lived asset group and its operating segment, are evaluated as indicators of possible impairment. Future cash flow value may include appraisals for property, plant and equipment, land and improvements, future cash flow estimates from



operating the long-lived assets, and other operating considerations. There were no significant charges for impairment of long-lived assets in the periods presented.

### ***Retirement Benefits***

We have defined benefit and defined contribution pension plans covering substantially all of our employees. Under U.S. generally accepted accounting principles, benefit expenses recognized in financial statements for defined benefit pension plans are determined on an actuarial basis, rather than as contributions are made to the plan. A significant element in determining our pension (expense) income in accordance with the accounting standards is the expected investment return on plan assets. In establishing the expected return on plan investments, which is reviewed annually in the fourth quarter, we take into consideration input from our third party pension plan asset managers and actuaries regarding the types of securities the plan assets are invested in, how those investments have performed historically, and expectations for how those investments will perform in the future. Our expected long-term return on pension plan investments was 8.5% in 2011. We apply this assumed rate to the market value of plan assets at the end of the previous year. This produces the expected return on plan assets that is included in annual pension (expense) income for the current year. The actual return on pension plan assets for the last five years have been 0.3% for 2011, 12.2% for 2010, 16.4% for 2009, a negative 25.3% for 2008, and 10.9% for 2007. Based upon our strategic allocation of pension assets across the various investments asset classes, and consideration of both historical and projected annual compound returns, our expected long-term return on pension plan investments for 2012 remains 8.50%. The effect of increasing, or lowering, the expected return on pension plan investments by 0.25% results in additional pre-tax annual income, or expense, of approximately \$5.3 million. The cumulative difference between this expected return and the actual return on plan assets is deferred and amortized into pension income or expense over future periods. The amount of expected return on plan assets can vary significantly from year-to-year since the calculation is dependent on the market value of plan assets as of the end of the preceding year. U.S. generally accepted accounting principles allow companies to calculate the expected return on pension assets using either an average of fair market values of pension assets over a period not to exceed five years, which reduces the volatility in reported pension income or expense, or their fair market value at the end of the previous year. However, the Securities and Exchange Commission currently does not permit companies to change from the fair market value at the end of the previous year methodology, which is the methodology that we use, to an averaging of fair market values of plan assets methodology. As a result, our results of operations and those of other companies, including companies with which we compete, may not be comparable due to these different methodologies in calculating the expected return on pension investments.

In accordance with accounting standards, we determine the discount rate used to value pension plan liabilities as of the last day of each year. The discount rate reflects the current rate at which the pension liabilities could be effectively settled. In estimating this rate, we receive input from our actuaries regarding the rates of return on high quality, fixed-income investments with maturities matched to the expected future retirement benefit payments. Based on this assessment at the end of December 2011, we established a discount rate of 5.0% for valuing the pension liabilities as of the end of 2011, and for determining the pension expense for 2012. We had previously assumed a discount rate of 5.8% at the end of 2010 and 6.2% for the end of 2009. The estimated effect of changing the discount rate by 0.50%, would decrease pension liabilities in the case of an increase in the discount rate, or increase pension liabilities in the case of a decrease in the discount rate by approximately \$150 million. Such a change in the discount rate would decrease pension expense in the case of an increase in the discount rate, or increase pension expense in the case of a decrease in the discount rate by approximately \$10 million. The effect on pension liabilities for changes to the discount rate, as well as the net effect of other changes in actuarial assumptions and experience, are deferred and amortized over future periods in accordance with the accounting standards.

As discussed above, gains and losses due to differences between actual and expected results for investment returns on plan assets, and changes in the discount rate used to value benefit obligations are deferred and recognized in the income statement over future periods. However for balance sheet presentation, these gains and losses are included in the determination of benefit obligations, net of plan assets, included on the year-end statement of financial position. At December 31, 2011, the Company had \$1.33 billion of pre-tax net actuarial losses, primarily related to continued declines in the discount rate used to value pension obligations, and also due to negative investment returns on plan assets in 2008, which have been recognized on the balance sheet through a reduction in stockholders' equity, and are being recognized in the income statement through expense amortizations over future years.

We also sponsor several postretirement plans covering certain hourly and salaried employees and retirees. These plans provide health care and life insurance benefits for eligible employees. Under most of the plans, our contributions towards premiums are capped based upon the cost as of certain dates, thereby creating a defined contribution. For the non-collectively bargained plans, we maintain the right to amend or terminate the plans in the future. In accordance with U.S. generally accepted accounting standards, postretirement expenses recognized in financial statements associated with defined benefit plans are determined on an actuarial basis, rather than as benefits are paid. We use actuarial assumptions, including the discount rate and the expected trend in health care costs, to estimate the costs and benefit obligations for these plans. The discount rate, which is determined annually at the end of each year, is developed based upon rates of return on high quality, fixed-income investments. At the end of 2011, we determined the rate to be 5.0%, compared to a 5.8% discount rate in 2010, and a 6.2% discount rate in 2009. The estimated effect of changing the discount rate by 0.50%, would decrease postretirement obligations in the case of an increase in the discount rate, or increase postretirement obligations in the case of a decrease in the discount rate by approximately \$22 million. Such a change in the discount rate would decrease postretirement benefit expense in the case of an increase in the discount rate, or increase postretirement benefit expense in the case of a decrease in the discount rate by approximately \$0.6 million. Based upon predictions of continued significant medical

cost inflation in future years, the annual assumed rate of increase in the per capita cost of covered benefits of health care plans is 9.1% in 2012 and is assumed to gradually decrease to 5.0% in the year 2028 and remain level thereafter.

Certain of these postretirement benefits are funded using plan investments held in a Company-administered VEBA trust. The December 31, 2011 asset balance is \$9 million and consists primarily of private equity investments. For 2011, our expected return on investments held in the VEBA trust was 8.3%, and our actual investment return was 17.6%. This assumed long-term rate of return on investments is applied to the market value of plan assets at the end of the previous year. This produces the expected return on plan investments that is included in annual postretirement benefits expenses for the current year. Our expected return on investments in the VEBA trust is 8.3% for 2012. The expected return on investments held in the VEBA trust is lower than the return on pension plan investments due to the mix of assets held by the VEBA trust and the expected reduction of VEBA trust assets due to benefit payments. The effect of increasing, or lowering, the expected return on postretirement benefit plan investments by 0.25% has a negligible effect on pre-tax annual income, or expense, due to the low level of investments held.

### **New Accounting Pronouncements Adopted**

On January 1, 2011, we prospectively adopted changes issued by the Financial Accounting Standards Board (FASB) to revenue recognition for multiple-deliverable arrangements. These changes affect the accounting and reporting of revenues related to bundled sales arrangements with customers to provide multiple products and services at different points in time or over different time periods. The adoption of these changes had no impact on the consolidated financial statements.

On January 1, 2011, we adopted changes issued by the FASB to disclosure requirements for disaggregated disclosure of fair value measurements using significant unobservable inputs, which are categorized as Level 3 in the fair value hierarchy.

In September 2011, the FASB issued changes to the disclosure requirements for employers who participate in multiemployer pension plans. The new standards require an employer to provide additional quantitative and qualitative disclosures, including disclosure of the significant multiemployer plans in which an employer participates, the level of an employer's participation in the significant multiemployer plans, including the employer's contributions made to the plans and an indication of whether the employer's contributions represent more than 5 percent of the total contributions made to the plan by all contributing employers. Additionally, the financial health of the significant multiemployer plans, including an indication of the funded status, whether funding improvement plans are pending or implemented, and whether the plan has imposed surcharges on the contributions to the plan. Finally, the required disclosures include the nature of the employer commitments to the plan, including when the collective-bargaining agreements that require contributions to the significant plans are set to expire and whether those agreements require minimum contributions to be made to the plans. These disclosures are included in Note 10. Pension Plans and Other Postretirement Benefits in the notes to the 2011 consolidated financial statements.

In September 2011, the FASB issued changes to the testing of goodwill for impairment. The changes are effective for interim and annual periods beginning after December 15, 2011, with early adoption permitted. We elected to early adopt this guidance which provides us with the option to first assess qualitative factors to determine whether the existence of events or circumstances leads to a determination that it is more likely than not (more than 50%) that the fair value of a reporting unit is less than its carrying amount. If we elect to perform a qualitative assessment and determine that an impairment is more likely than not, we are then required to perform the existing two-step quantitative impairment test, otherwise no further analysis is required. We also may elect not to perform the qualitative assessment and, instead, proceed directly to the two-step quantitative impairment test.

### **Forward-Looking Statements**

From time-to-time, the Company has made and may continue to make "forward-looking statements" within the meaning of the Private Securities Litigation Reform Act of 1995. Certain statements in this report relate to future events and expectations and, as such, constitute forward-looking statements. Forward-looking statements include those containing such words as "anticipates," "believes," "estimates," "expects," "would," "should," "will," "will likely result," "forecast," "outlook," "projects," and similar expressions. Such forward-looking statements are based on management's current expectations and include known and unknown risks, uncertainties and other factors, many of which the Company is unable to predict or control, that may cause our actual results or performance to materially differ from any future results or performance expressed or implied by such statements. Various of these factors are described in Item 1A, Risk Factors, of this Annual Report on Form 10-K and will be described from time-to-time in the Company filings with the Securities and Exchange Commission ("SEC"), including the Company's Annual Reports on Form 10-K and the Company's subsequent reports filed with the SEC on Form 10-Q and Form 8-K, which are available on the SEC's website at <http://www.sec.gov> and on the Company's website at <http://www.atimetals.com>. We assume no duty to update our forward-looking statements.

### **Item 7A. Quantitative and Qualitative Disclosures About Market Risk**

As part of our risk management strategy, we utilize derivative financial instruments, from time to time, to hedge our exposure to changes in raw material prices, foreign currencies, and interest rates. We monitor the third-party financial institutions which are our counterparty to these financial instruments on a daily basis and diversify our transactions among counterparties to minimize exposure

to any one of these entities. Fair values for derivatives were measured using exchange-traded prices for the hedged items including consideration of counterparty risk and the Company's credit risk.

**Interest Rate Risk.** We attempt to maintain a reasonable balance between fixed- and floating-rate debt to keep financing costs as low as possible. At December 31, 2011, we had approximately \$25 million of floating rate debt outstanding with a weighted average interest rate of approximately 1.6%. Since the interest rate on floating rate debt changes with the short-term market rate of interest, we are exposed to the risk that these interest rates may increase, raising our interest expense. For example, a hypothetical 1% increase in the rate of interest on the \$25 million of our outstanding floating rate debt would result in increased annual financing costs of approximately \$0.3 million.

**Volatility of Energy Prices.** Energy resources markets are subject to conditions that create uncertainty in the prices and availability of energy resources. The prices for and availability of electricity, natural gas, oil and other energy resources are subject to volatile market conditions. These market conditions often are affected by political and economic factors beyond our control. Increases in energy costs, or changes in costs relative to energy costs paid by competitors, have and may continue to adversely affect our profitability. To the extent that these uncertainties cause suppliers and customers to be more cost sensitive, increased energy prices may have an adverse effect on our results of operations and financial condition. We use approximately 8 to 10 million MMBtu's of natural gas annually, depending upon business conditions, in the manufacture of our products. These purchases of natural gas expose us to risk of higher gas prices. For example, a hypothetical \$1.00 per MMBtu increase in the price of natural gas would result in increased annual energy costs of approximately \$8 to \$10 million. We use several approaches to minimize any material adverse effect on our financial condition or results of operations from volatile energy prices. These approaches include incorporating an energy surcharge on many of our products and using financial derivatives to reduce exposure to energy price volatility.

At December 31, 2011, the outstanding financial derivatives used to hedge our exposure to natural gas cost volatility represented approximately 70% of our forecasted requirements for 2012, 50% for 2013 and 10% for 2014. The net mark-to-market valuation of these outstanding hedges at December 31, 2011 was an unrealized pre-tax loss of \$13.4 million, of which \$10.1 million was presented in accrued liabilities and \$3.3 million was presented in other long-term liabilities. The effects of the hedging activity will be recognized in income over the designated hedge periods. For the year ended December 31, 2011, the effects of natural gas hedging activity increased cost of sales by \$12.5 million.

**Volatility of Raw Material Prices.** We use raw materials surcharge and index mechanisms to offset the impact of increased raw material costs; however, competitive factors in the marketplace can limit our ability to institute such mechanisms, and there can be a delay between the increase in the price of raw materials and the realization of the benefit of such mechanisms. For example, in 2011 we used approximately 95 million pounds of nickel; therefore a hypothetical change of \$1.00 per pound in nickel prices would result in increased costs of approximately \$95 million. In addition, in 2011 we also used approximately 810 million pounds of ferrous scrap in the production of our flat-rolled products and a hypothetical change of \$0.01 per pound would result in increased costs of approximately \$8 million. While we enter into raw materials futures contracts from time-to-time to hedge exposure to price fluctuations, such as for nickel, we cannot be certain that our hedge position adequately reduces exposure. We believe that we have adequate controls to monitor these contracts, but we may not be able to accurately assess exposure to price volatility in the markets for critical raw materials.

The majority of our products are sold utilizing raw material surcharges and index mechanisms. However as of December 31, 2011, we had entered into financial hedging arrangements primarily at the request of our customers related to firm orders, for an aggregate amount of less than 9% of our estimated annual nickel requirements. These nickel hedges extend to 2016. Any gain or loss associated with these hedging arrangements is included in cost of sales. At December 31, 2011, the net mark-to-market valuation of our outstanding raw material hedges was an unrealized pre-tax gain of \$0.1 million, comprised of \$0.7 million in prepaid expenses, \$1.1 million in other current assets, \$1.6 million in accrued liabilities and \$0.1 million in other long-term liabilities.

**Foreign Currency Risk.** Foreign currency exchange contracts are used, from time-to-time, to limit transactional exposure to changes in currency exchange rates. We sometimes purchase foreign currency forward contracts that permit us to sell specified amounts of foreign currencies expected to be received from our export sales for pre-established U.S. dollar amounts at specified dates. The forward contracts are denominated in the same foreign currencies in which export sales are denominated. These contracts are designated as hedges of the variability in cash flows of a portion of the forecasted future export sales transactions which otherwise would expose the Company to foreign currency risk. At December 31, 2011, the outstanding financial derivatives used to hedge our exposure to foreign currency, primarily euros, represented approximately 10% of our forecasted total international sales through 2013. At December 31, 2011, the net mark-to-market valuation of the outstanding foreign currency forward contracts was an unrealized pre-tax gain of \$15.4 million, of which \$9.5 million is included in prepaid expenses and other assets and \$5.9 million is presented in other long-term assets. In addition, we may also designate cash balances held in foreign currencies as hedges of forecasted foreign currency transactions.

## **Item 8. Financial Statements and Supplementary Data**

### ***Report of Independent Registered Public Accounting Firm***

#### **The Board of Directors and Stockholders of Allegheny Technologies Incorporated**

We have audited the accompanying consolidated balance sheets of Allegheny Technologies Incorporated and Subsidiaries as of December 31, 2011 and 2010, and the related consolidated statements of income, cash flows, and changes in equity for each of the three years in the period ended December 31, 2011. These financial statements are the responsibility of the Company's management. Our responsibility is to express an opinion on these financial statements based on our audits.

We conducted our audits in accordance with the standards of the Public Company Accounting Oversight Board (United States). Those standards require that we plan and perform the audit to obtain reasonable assurance about whether the financial statements are free of material misstatement. An audit includes examining, on a test basis, evidence supporting the amounts and disclosures in the financial statements. An audit also includes assessing the accounting principles used and significant estimates made by management, as well as evaluating the overall financial statement presentation. We believe that our audits provide a reasonable basis for our opinion.

In our opinion, the financial statements referred to above present fairly, in all material respects, the consolidated financial position of Allegheny Technologies Incorporated and Subsidiaries at December 31, 2011 and 2010, and the consolidated results of their operations and their cash flows for each of the three years in the period ended December 31, 2011, in conformity with U.S. generally accepted accounting principles.

We also have audited, in accordance with the standards of the Public Company Accounting Oversight Board (United States), Allegheny Technologies Incorporated and Subsidiaries' internal control over financial reporting as of December 31, 2011, based on criteria established in Internal Control-Integrated Framework issued by the Committee of Sponsoring Organizations of the Treadway Commission and our report dated February 27, 2012 expressed an unqualified opinion thereon.

/s/ Ernst & Young LLP

Pittsburgh, Pennsylvania  
February 27, 2012



**Allegheny Technologies Incorporated and Subsidiaries**  
**Consolidated Statements of Income**

*(In millions, except per share amounts)*

<b>For the Years Ended December 31,</b>	<b>2011</b>	2010	2009
<b>Sales</b>	<b>\$ 5,183.0</b>	\$ 4,047.8	\$ 3,054.9
Costs and expenses:			
Cost of sales	<b>4,369.8</b>	3,557.5	2,646.5
Selling and administrative expenses	<b>382.1</b>	304.9	315.7
Income before interest, other income and income taxes	<b>431.1</b>	185.4	92.7
Interest expense, net	<b>(92.3)</b>	(62.7)	(19.3)
Debt extinguishment costs	-	-	(9.2)
Other income, net	<b>0.6</b>	3.0	0.7
Income before income taxes	<b>339.4</b>	125.7	64.9
Income tax provision	<b>116.3</b>	47.0	26.9
Net income	<b>223.1</b>	78.7	38.0
Less: Net income attributable to noncontrolling interests	<b>8.8</b>	8.0	6.3
<b>Net income attributable to ATI</b>	<b>\$ 214.3</b>	\$ 70.7	\$ 31.7
Basic net income attributable to ATI per common share	<b>\$ 2.09</b>	\$ 0.73	\$ 0.33
Diluted net income attributable to ATI per common share	<b>\$ 1.97</b>	\$ 0.72	\$ 0.32

*The accompanying notes are an integral part of these statements.*

**Allegheny Technologies Incorporated and Subsidiaries**  
**Consolidated Balance Sheets**

<i>(In millions, except share and per share amounts)</i>	<b>December 31, 2011</b>	<b>December 31, 2010</b>
<b>Assets</b>		
Cash and cash equivalents	\$ 380.6	\$ 432.3
Accounts receivable, net	709.1	545.4
Inventories, net	1,384.3	1,024.5
Prepaid expenses and other current assets	95.5	112.9
<b>Total Current Assets</b>	<b>2,569.5</b>	<b>2,115.1</b>
Property, plant and equipment, net	2,368.8	1,989.3
Cost in excess of net assets acquired	737.7	206.8
Other assets	370.9	182.4
<b>Total Assets</b>	<b>\$ 6,046.9</b>	<b>\$ 4,493.6</b>
<b>Liabilities and Stockholders' Equity</b>		
Accounts payable	\$ 490.7	\$ 394.1
Accrued liabilities	320.3	249.9
Deferred income taxes	23.5	5.6
Short-term debt and current portion of long-term debt	27.3	141.4
<b>Total Current Liabilities</b>	<b>861.8</b>	<b>791.0</b>
Long-term debt	1,482.0	921.9
Accrued postretirement benefits	488.1	423.8
Pension liabilities	508.9	58.3
Deferred income taxes	9.8	68.6
Other long-term liabilities	124.7	100.6
<b>Total Liabilities</b>	<b>3,475.3</b>	<b>2,364.2</b>
<b>Equity:</b>		
<b>ATI Stockholders' Equity:</b>		
Preferred stock, par value \$0.10: authorized-50,000,000 shares; issued-none	-	-
Common stock, par value \$0.10: authorized-500,000,000 shares; issued-109,695,171 shares at December 31, 2011 and 102,404,256 at December 31, 2010; outstanding-106,354,612 shares at December 31, 2011 and 98,542,291 shares at December 31, 2010	11.0	10.2
Additional paid-in capital	1,207.1	658.9
Retained earnings	2,361.5	2,224.8
Treasury stock: 3,340,559 shares at December 31, 2011 and 3,861,965 shares at December 31, 2010	(162.7)	(188.0)
Accumulated other comprehensive loss, net of tax	(941.6)	(665.1)
<b>Total ATI Stockholders' Equity</b>	<b>2,475.3</b>	<b>2,040.8</b>
<b>Noncontrolling Interests</b>	<b>96.3</b>	<b>88.6</b>
<b>Total Stockholders' Equity</b>	<b>2,571.6</b>	<b>2,129.4</b>
<b>Total Liabilities and Stockholders' Equity</b>	<b>\$ 6,046.9</b>	<b>\$ 4,493.6</b>

*The accompanying notes are an integral part of these statements.*

**Allegheny Technologies Incorporated and Subsidiaries**  
**Consolidated Statements of Cash Flows**

(In millions)

For the Years Ended December 31,

	2011	2010	2009
<b>Operating Activities:</b>			
Net income	\$ 223.1	\$ 78.7	\$ 38.0
Adjustments to reconcile net income to net cash provided by operating activities:			
Depreciation and amortization	174.4	141.5	132.6
Deferred taxes	52.7	102.2	123.6
Change in operating assets and liabilities:			
Retirement benefits (a)	19.6	34.3	(280.6)
Accounts receivable	(78.8)	(153.4)	141.4
Inventories	(227.3)	(199.0)	67.8
Accounts payable	50.0	85.5	30.1
Accrued income taxes	42.4	(32.2)	(26.6)
Accrued liabilities and other	40.7	(30.5)	(7.8)
<b>Cash provided by operating activities</b>	<b>296.8</b>	<b>27.1</b>	<b>218.5</b>
<b>Investing Activities:</b>			
Purchases of property, plant and equipment	(278.2)	(219.1)	(415.4)
Purchases of businesses and investments in ventures	(349.2)	-	(38.9)
Asset disposals and other	2.7	2.3	0.6
<b>Cash used in investing activities</b>	<b>(624.7)</b>	<b>(216.8)</b>	<b>(453.7)</b>
<b>Financing Activities:</b>			
Issuances of long-term debt	500.0	-	752.5
Payments on long-term debt and capital leases	(143.8)	(11.3)	(194.6)
Net borrowings (repayments) under credit facilities	(3.1)	2.9	5.8
Debt issuance costs	(5.0)	-	(18.1)
Dividends paid to shareholders	(74.7)	(70.8)	(70.6)
Purchase of subsidiary shares from noncontrolling interest	(0.2)	-	-
Shares repurchased for income tax withholding on share-based compensation	(2.2)	(0.9)	(1.4)
Dividends paid to noncontrolling interests	(7.2)	-	(0.8)
Exercises of stock options	1.6	1.4	0.8
Taxes on share-based compensation	10.8	(8.1)	0.5
<b>Cash provided by (used in) financing activities</b>	<b>276.2</b>	<b>(86.8)</b>	<b>474.1</b>
<b>Increase (decrease) in cash and cash equivalents</b>	<b>(51.7)</b>	<b>(276.5)</b>	<b>238.9</b>
<b>Cash and cash equivalents at beginning of year</b>	<b>432.3</b>	<b>708.8</b>	<b>469.9</b>
<b>Cash and cash equivalents at end of year</b>	<b>\$ 380.6</b>	<b>\$ 432.3</b>	<b>\$ 708.8</b>

(a) Includes voluntary cash contribution of \$(350) million in 2009.

Amounts presented on the Consolidated Statements of Cash Flows may not agree to the corresponding changes in balance sheet items due to the accounting for purchases and sales of businesses and the effects of foreign currency translation.

The accompanying notes are an integral part of these statements.

**Allegheny Technologies Incorporated and Subsidiaries**  
**Statements of Changes in Consolidated Equity**

	<b>ATI Stockholders</b>							
	Common Stock	Additional Paid-In Capital	Retained Earnings	Treasury Stock	Accumulated Other Comprehensive Income (Loss)	Comprehensive Income (Loss)	Non- controlling Interests	Total Equity
<i>(In millions, except per share amounts)</i>								
Balance, December 31, 2008	\$ 10.2	\$ 651.8	\$ 2,286.7	\$ (244.8)	\$ (746.5)		\$ 71.6	\$ 2,029.0
<b>Net income</b>	-	-	<b>31.7</b>	-	-	<b>31.7</b>	<b>6.3</b>	<b>38.0</b>
Other comprehensive income net of tax:								
Pension plans and other								
postretirement benefits	-	-	-	-	19.9	19.9	-	19.9
Foreign currency translation gains	-	-	-	-	21.9	21.9	0.3	22.2
Unrealized gains on derivatives	-	-	-	-	31.2	31.2	-	31.2
<b>Comprehensive income</b>	-	-	<b>31.7</b>	-	<b>73.0</b>	<b>\$ 104.7</b>	<b>6.6</b>	<b>111.3</b>
Cash dividends on common stock (\$0.72 per share)	-	-	(70.6)	-	-		-	(70.6)
Dividends paid to noncontrolling interest	-	-	-	-	-		(0.8)	(0.8)
Employee stock plans	-	1.8	(17.3)	36.2	-		-	20.7
<b>Balance, December 31, 2009</b>	<b>\$ 10.2</b>	<b>\$ 653.6</b>	<b>\$ 2,230.5</b>	<b>\$ (208.6)</b>	<b>\$ (673.5)</b>		<b>\$ 77.4</b>	<b>\$ 2,089.6</b>
<b>Net income</b>	-	-	<b>70.7</b>	-	-	<b>70.7</b>	<b>8.0</b>	<b>78.7</b>
Other comprehensive income (loss) net of tax:								
Pension plans and other								
postretirement benefits	-	-	-	-	24.2	24.2	-	24.2
Foreign currency translation gains (losses)	-	-	-	-	(8.6)	(8.6)	3.2	(5.4)
Unrealized losses on derivatives	-	-	-	-	(7.2)	(7.2)	-	(7.2)
<b>Comprehensive income</b>	-	-	<b>70.7</b>	-	<b>8.4</b>	<b>\$ 79.1</b>	<b>11.2</b>	<b>90.3</b>
Cash dividends on common stock (\$0.72 per share)	-	-	(70.8)	-	-		-	(70.8)
Employee stock plans	-	5.3	(5.6)	20.6	-		-	20.3
<b>Balance, December 31, 2010</b>	<b>\$ 10.2</b>	<b>\$ 658.9</b>	<b>\$ 2,224.8</b>	<b>\$ (188.0)</b>	<b>\$ (665.1)</b>		<b>\$ 88.6</b>	<b>\$ 2,129.4</b>
<b>Net income</b>	-	-	<b>214.3</b>	-	-	<b>214.3</b>	<b>8.8</b>	<b>223.1</b>
Other comprehensive income (loss) net of tax:								
Pension plans and other								
postretirement benefits	-	-	-	-	(277.1)	(277.1)	-	(277.1)
Foreign currency translation gains (losses)	-	-	-	-	(3.1)	(3.1)	5.8	2.7
Unrealized gains on derivatives	-	-	-	-	3.8	3.8	-	3.8
Unrealized losses on equity securities	-	-	-	-	(0.1)	(0.1)	-	(0.1)
<b>Comprehensive income (loss)</b>	-	-	<b>214.3</b>	-	<b>(276.5)</b>	<b>\$ (62.2)</b>	<b>14.6</b>	<b>(47.6)</b>
Issuance of common stock	0.8	512.8	-	-	-		-	513.6
Cash dividends on common stock (\$0.72 per share)	-	-	(74.7)	-	-		-	(74.7)
Noncontrolling interest acquired	-	-	-	-	-		0.7	0.7
Purchase of subsidiary shares from								
noncontrolling interest	-	0.2	-	-	-		(0.4)	(0.2)
Dividends paid to noncontrolling interest	-	-	-	-	-		(7.2)	(7.2)
Employee stock plans	-	35.2	(2.9)	25.3	-		-	57.6
<b>Balance, December 31, 2011</b>	<b>\$ 11.0</b>	<b>\$ 1,207.1</b>	<b>\$ 2,361.5</b>	<b>\$ (162.7)</b>	<b>\$ (941.6)</b>		<b>\$ 96.3</b>	<b>\$ 2,571.6</b>

The accompanying notes are an integral part of these statements.



## ***Notes to Consolidated Financial Statements***

### **Note 1. Summary of Significant Accounting Policies**

#### ***Principles of Consolidation***

The consolidated financial statements include the accounts of Allegheny Technologies Incorporated and its subsidiaries, including the Chinese joint venture known as Shanghai STAL Precision Stainless Steel Company Limited (“STAL”), in which the Company has a 60% interest. The remaining 40% interest in STAL is owned by Baosteel Group, a state authorized investment company whose equity securities are publicly traded in the People’s Republic of China. The financial results of STAL are consolidated into the Company’s operating results and financial position, with the 40% interest of our minority partner recognized in the consolidated statement of income as net income attributable to noncontrolling interests and as equity attributable to the noncontrolling interest within total stockholders’ equity. Investments in which the Company exercises significant influence, but which it does not control (generally a 20% to 50% ownership interest), including ATI’s 50% interest in the industrial titanium joint venture known as Uniti LLC (“Uniti”), are accounted for under the equity method of accounting. Significant intercompany accounts and transactions have been eliminated. Unless the context requires otherwise, “Allegheny Technologies,” “ATI” and the “Company” refer to Allegheny Technologies Incorporated and its subsidiaries.

#### ***Use of Estimates***

The preparation of consolidated financial statements in conformity with United States generally accepted accounting principles requires management to make estimates and assumptions that affect reported amounts of assets and liabilities at the date of the financial statements, as well as the reported amounts of income and expenses during the reporting period. Actual results could differ from those estimates. Management believes that the estimates are reasonable.

#### ***Cash Equivalents and Investments***

Cash equivalents are highly liquid investments valued at cost, which approximates fair value, acquired with an original maturity of three months or less.

#### ***Accounts Receivable***

Accounts receivable are presented net of a reserve for doubtful accounts of \$5.9 million at December 31, 2011 and \$5.6 million at December 31, 2010. The Company markets its products to a diverse customer base, principally throughout the United States. Trade credit is extended based upon evaluations of each customer’s ability to perform its obligations, which are updated periodically. Accounts receivable reserves are determined based upon an aging of accounts and a review for collectability of specific accounts. No single customer accounted for more than 10% of sales for all years presented. Accounts receivable from Uniti were \$18.5 million and \$7.9 million at December 31, 2011 and 2010, respectively.

#### ***Inventories***

Inventories are stated at the lower of cost (last-in, first-out (LIFO), first-in, first-out (FIFO), and average cost methods) or market, less progress payments. Costs include direct material, direct labor and applicable manufacturing and engineering overhead, and other direct costs. Most of the Company’s inventory is valued utilizing the LIFO costing methodology. Inventory of the Company’s non-U.S. operations is valued using average cost or FIFO methods.

The Company evaluates product lines on a quarterly basis to identify inventory values that exceed estimated net realizable value. The calculation of a resulting reserve, if any, is recognized as an expense in the period that the need for the reserve is identified. It is the Company’s general policy to write-down to scrap value any inventory that is identified as obsolete and any inventory that has aged or has not moved in more than twelve months. In some instances this criterion is up to twenty-four months.

#### ***Long-Lived Assets***

Property, plant and equipment are recorded at cost, including capitalized interest, and includes long-lived assets acquired under capital leases. The principal method of depreciation adopted for all property placed into service after July 1, 1996 is the straight-line method. For buildings and equipment acquired prior to July 1, 1996, depreciation is computed using a combination of accelerated and straight-line methods. Property, plant and equipment associated with the Company’s titanium sponge facility in Rowley, UT is being depreciated utilizing the units of production method of depreciation, which the Company believes provides a

better matching of costs and revenues. The Company periodically reviews estimates of useful life and production capacity assigned to new and in service assets. Significant enhancements, including major maintenance activities that extend the lives of property and equipment, are capitalized. Costs related to repairs and maintenance are charged to expense in the period incurred. The cost and related accumulated depreciation of property and equipment retired or disposed of are removed from the accounts and any related gains or losses are included in income.

The Company monitors the recoverability of the carrying value of its long-lived assets. An impairment charge is recognized when an indicator of impairment occurs and the expected net undiscounted future cash flows from an asset's use (including any proceeds from disposition) are less than the asset's carrying value and the asset's carrying value exceeds its fair value. Assets to be disposed of by sale are stated at the lower of their fair values or carrying amounts and depreciation is no longer recognized.

### ***Cost in Excess of Net Assets Acquired***

At December 31, 2011, the Company had \$737.7 million of goodwill on its balance sheet. Of the total, \$598.7 million related to the High Performance Metals segment, \$112.1 million related to the Flat-Rolled Products segment, and \$26.9 million related to the Engineered Products segment. Goodwill increased \$530.0 million during 2011 as a result of the acquisition of Ladish, as well as the \$0.9 million impact of foreign currency translation on goodwill denominated in functional currencies other than the U.S. dollar. Goodwill and indefinite-lived intangible assets are reviewed annually for impairment or more frequently if impairment indicators arise. The review for goodwill impairment requires a comparison of the fair value of each reporting unit that has goodwill associated with its operations with its carrying amount, including goodwill. If this comparison reflects impairment, then the loss would be measured as the excess of recorded goodwill over its implied fair value. Implied fair value is the excess of the fair value of the reporting unit over the fair value of all recognized and unrecognized assets and liabilities.

Changes in accounting standards, which were adopted by the Company in 2011, provide the option to qualitatively assess goodwill for impairment before completing a quantitative assessment. Under the qualitative approach, if, after assessing the totality of events or circumstances, including both macroeconomic, industry and market factors, and entity-specific factors, the Company determines it is likely (more likely than not) that the fair value of a reporting unit is greater than its carrying amount, then the quantitative impairment analysis is not required. The quantitative assessment may be performed each year for a reporting unit at the Company's option without first performing a qualitative assessment. The Company's quantitative assessment of goodwill for possible impairment includes estimating the fair market value of a reporting unit which has goodwill associated with its operations using discounted cash flow and multiples of cash earnings valuation techniques, plus valuation comparisons to recent public sale transactions of similar businesses, if any. These impairment assessments and valuation methods require the Company to make estimates and assumptions regarding future operating results, cash flows, changes in working capital and capital expenditures, selling prices, profitability, and the cost of capital. Many of these assumptions are determined by reference to market participants identified by the Company. Although management believes that the estimates and assumptions used were reasonable, actual results could differ from those estimates and assumptions. The Company performs the required annual goodwill impairment evaluation in the fourth quarter of each year. No impairment of goodwill was determined to exist for the years ended December 31, 2011, 2010 or 2009.

### ***Environmental***

Costs that mitigate or prevent future environmental contamination or extend the life, increase the capacity or improve the safety or efficiency of property utilized in current operations are capitalized. Other costs that relate to current operations or an existing condition caused by past operations are expensed. Environmental liabilities are recorded when the Company's liability is probable and the costs are reasonably estimable, but generally not later than the completion of the feasibility study or the Company's recommendation of a remedy or commitment to an appropriate plan of action. The accruals are reviewed periodically and, as investigations and remediations proceed, adjustments of the accruals are made to reflect new information as appropriate. Accruals for losses from environmental remediation obligations do not take into account the effects of inflation, and anticipated expenditures are not discounted to their present value. The accruals are not reduced by possible recoveries from insurance carriers or other third parties, but do reflect allocations among potentially responsible parties ("PRPs") at Federal Superfund sites or similar state-managed sites after an assessment is made of the likelihood that such parties will fulfill their obligations at such sites and after appropriate cost-sharing or other agreements are entered. The measurement of environmental liabilities by the Company is based on currently available facts, present laws and regulations, and current technology. Such estimates take into consideration the Company's prior experience in site investigation and remediation, the data concerning cleanup costs available from other companies and regulatory authorities, and the professional judgment of the Company's environmental experts in consultation with outside environmental specialists, when necessary.

### ***Foreign Currency Translation***

Assets and liabilities of international operations are translated into U.S. dollars using year-end exchange rates, while revenues and expenses are translated at average exchange rates during the period. The resulting net translation adjustments are recorded as a component of accumulated other comprehensive income (loss) in stockholders' equity.

### ***Sales Recognition***

Sales are recognized when title passes or as services are rendered.

### ***Research and Development***

Company funded research and development costs were \$19.3 million in 2011, \$16.5 million in 2010, and \$19.3 million in 2009 and were expensed as incurred. Customer funded research and development costs were \$1.5 million in 2011, \$0.8 million in 2010, and \$0.3 million in 2009. Customer funded research and development costs are recognized in the consolidated statement of income in accordance with revenue recognition policies.

### ***Stock-based Compensation***

The Company accounts for stock-based compensation transactions, such as stock options, restricted stock, and potential payments under programs such as the Company's Total Shareholder Return Program ("TSRP") awards, using fair value. Compensation expense for an award is estimated at the date of grant and is recognized over the requisite service period. Compensation expense is adjusted for equity awards that do not vest because service or performance conditions are not satisfied. However, compensation expense already recognized is not adjusted if market conditions are not met, such as the Company's total shareholder return performance relative to a peer group under the Company's TSRP awards, or for stock options which expire "out-of-the-money."

### ***Income Taxes***

The provision for, or benefit from, income taxes includes deferred taxes resulting from temporary differences in income for financial and tax purposes using the liability method. Such temporary differences result primarily from differences in the carrying value of assets and liabilities. Future realization of deferred income tax assets requires sufficient taxable income within the carryback, carryforward period available under tax law.

The Company evaluates, on a quarterly basis whether, based on all available evidence, it is probable that the deferred income tax assets are realizable. Valuation allowances are established when it is estimated that it is more likely than not that the tax benefit of the deferred tax asset will not be realized. The evaluation includes the consideration of all available evidence, both positive and negative, regarding historical operating results including recent years with reported losses, the estimated timing of future reversals of existing taxable temporary differences, estimated future taxable income exclusive of reversing temporary differences and carryforwards, and potential tax planning strategies which may be employed to prevent an operating loss or tax credit carryforward from expiring unused.

It is the Company's policy to classify interest and penalties recognized on underpayment of income taxes as income tax expense.

### ***Net Income Per Common Share***

Basic and diluted net income per share are calculated by dividing the net income available to common stockholders by the weighted average number of common shares outstanding during the year. Diluted amounts assume the issuance of common stock for all potentially dilutive share equivalents outstanding. The calculation of diluted net loss per share, if any, excludes the potentially dilutive effect of dilutive share equivalents since the inclusion in the calculation of additional shares in the net loss per share would result in a lower per share loss and therefore be anti-dilutive.

### ***New Accounting Pronouncements Adopted***

On January 1, 2011, the Company prospectively adopted changes issued by the Financial Accounting Standards Board (FASB) to revenue recognition for multiple-deliverable arrangements. These changes affect the accounting and reporting of revenues related to bundled sales arrangements with customers to provide multiple products and services at different points in time or over different time periods. The adoption of these changes had no impact on the consolidated financial statements.

On January 1, 2011, the Company adopted changes issued by the FASB to disclosure requirements for disaggregated disclosure of fair value measurements using significant unobservable inputs, which are categorized as Level 3 in the fair value hierarchy. These changes are included in the December 31, 2011 consolidated financial statements.

In September 2011, the FASB issued changes to the disclosure requirements for employers who participate in multiemployer pension plans. The new standards require an employer to provide additional quantitative and qualitative disclosures, including disclosure of the significant multiemployer plans in which an employer participates, the level of an employer's participation in the significant multiemployer plans, including the employer's contributions made to the plans and an indication of whether the employer's contributions represent more than five percent of the total contributions made to the plan by all contributing employers. Additionally, the financial health of the significant multiemployer plans, including an indication of the funded status, whether funding improvement plans are pending or implemented, and whether the plan has imposed surcharges on the contributions to the plan. Finally, the required disclosures include the nature of the employer commitments to the plan, including when the collective-bargaining agreements that require contributions to the significant plans are set to expire and whether those agreements require minimum contributions to be made to the plans. These disclosures are included in Note 10. Pension Plans and Other Postretirement Benefits.

In September 2011, the FASB issued changes to the testing of goodwill for impairment. The changes are effective for interim and annual periods beginning after December 15, 2011, with early adoption permitted. The Company elected to early adopt this guidance which provides the Company with the option to first assess qualitative factors to determine whether the existence of events or circumstances leads to a determination that it is more likely than not (more than 50%) that the fair value of a reporting unit is less than its carrying amount. If an entity elects to perform a qualitative assessment and determines that an impairment is more likely than not, the entity is then required to perform the existing two-step quantitative impairment test, otherwise no further analysis is required. An entity also may elect not to perform the qualitative assessment and, instead, go directly to the two-step quantitative impairment test.

### **Pending Accounting Pronouncements**

In June 2011, the FASB issued changes to the presentation of comprehensive income which requires entities to present the total of comprehensive income, the components of net income, and the components of other comprehensive income either in a single continuous statement of comprehensive income or in two separate but consecutive statements. Additionally, these changes require an entity to present on the face of the financial statements reclassification adjustments for items that are reclassified from other comprehensive income to net income in the statement(s) where the components of net income and the components of other comprehensive income are presented. In December 2011, the FASB deferred the requirement for presenting the reclassification adjustments from comprehensive income to net income by component within the face of the financial statements. The option to present components of other comprehensive income as part of the statement of changes in stockholders' equity, which is the method of presentation used by ATI, will no longer be permitted. Finally, no changes were made to the calculation and presentation of earnings per share. These changes, with retrospective application, become effective for ATI for interim and annual periods in fiscal year 2012. Other than the change in presentation, these changes will not have an impact on the consolidated financial statements.

### **Note 2. Acquisition of Business**

On May 9, 2011, ATI completed the acquisition of Ladish Co., Inc. (Ladish) for \$897.6 million, comprised of the issuance of 7.3 million shares of ATI common stock and payment of \$384 million in cash (\$349.2 million, net of cash acquired). ATI Ladish results are included in the High Performance Metals segment from the date of the acquisition. Based in Wisconsin, ATI Ladish engineers, produces and markets high-strength, high technology forged and cast metal components for a wide variety of load-bearing and fatigue-resisting applications in the jet engine, aerospace and industrial markets, for both domestic and international customers. Ladish sales in 2010 were \$403.1 million. Based on the final purchase price allocation, goodwill of \$530 million and intangible assets of \$166 million were recorded for this transaction. Pro forma financial information has not been included because the acquisition did not meet certain significance thresholds.



### Note 3. Inventories

Inventories at December 31, 2011 and 2010 were as follows (in millions):

	2011	2010
Raw materials and supplies	\$ 205.7	\$ 169.3
Work-in-process	1,150.0	892.8
Finished goods	199.9	126.5
Total inventories at current cost	1,555.6	1,188.6
Less allowances to reduce current cost values to LIFO basis	(153.7)	(163.0)
Progress payments	(17.6)	(1.1)
Total inventories, net	\$ 1,384.3	\$ 1,024.5

Inventories, before progress payments, determined on the last-in, first-out (“LIFO”) method were \$987.1 million at December 31, 2011, and \$844.2 million at December 31, 2010. The remainder of the inventory was determined using the first-in, first-out (“FIFO”) and average cost methods, and these inventory values do not differ materially from current cost. The effect of using the LIFO methodology to value inventory, rather than FIFO, decreased cost of sales in 2011 by \$9.3 million. In 2010 the impact of using the LIFO methodology, rather than FIFO, increased costs of sales by \$60.2 million while in 2009 the impact was a decrease to cost of sales in the amount \$102.8 million.

During 2011, 2010, and 2009, inventory usage resulted in liquidations of LIFO inventory quantities. These inventories were carried at differing costs prevailing in prior years as compared with the cost of current manufacturing cost and purchases. The effect of these LIFO liquidations was to increase cost of sales by \$0.1 million in 2011, decrease cost of sales by \$1.8 million in 2010 and increase cost of sales by \$1.8 million in 2009.

### Note 4. Property, Plant and Equipment

Property, plant and equipment at December 31, 2011 and 2010 was as follows:

<i>(In millions)</i>	2011	2010
Land	\$ 34.0	\$ 25.8
Buildings	757.0	638.2
Equipment and leasehold improvements	3,146.2	2,750.8
	3,937.2	3,414.8
Accumulated depreciation and amortization	(1,568.4)	(1,425.5)
Total property, plant and equipment, net	\$ 2,368.8	\$ 1,989.3

Construction in progress at December 31, 2011 and 2010 was \$346.2 million and \$184.5 million, respectively. Depreciation and amortization for the years ended December 31, 2011, 2010 and 2009 was as follows:

<i>(In millions)</i>	2011	2010	2009
Depreciation of property, plant and equipment	\$ 152.8	\$ 126.3	\$ 118.1
Software and other amortization	21.6	15.2	14.5
Total depreciation and amortization	\$ 174.4	\$ 141.5	\$ 132.6

### Note 5. Asset Retirement Obligations

The Company maintains reserves where a legal obligation exists to perform an asset retirement activity and the fair value of the liability can be reasonably estimated. These asset retirement obligations (“ARO”) include liabilities where the timing and (or) method of settlement may be conditional on a future event, that may or may not be within the control of the entity. At December 31, 2011, the Company had recognized AROs of \$12.8 million related to landfill closures, facility leases and conditional AROs associated with manufacturing activities using what may be characterized as potentially hazardous materials.

Estimates of AROs are evaluated annually in the fourth quarter, or more frequently if material new information becomes known. Accounting for asset retirement obligations requires significant estimation and in certain cases, the Company has

determined that an ARO exists, but the amount of the obligation is not reasonably estimable. The Company may determine that additional AROs are required to be recognized as new information becomes available.

Changes in asset retirement obligations for the years ended December 31, 2011 and 2010 were as follows:

<i>(in millions)</i>	<b>2011</b>	<b>2010</b>
Balance at beginning of year	\$ <b>13.2</b>	\$ 14.7
Accretion expense	<b>1.1</b>	1.4
Payments	<b>(1.6)</b>	(2.5)
Revision of estimates	<b>(0.6)</b>	(1.0)
Liabilities incurred	<b>0.7</b>	0.6
Balance at end of year	<b>\$ 12.8</b>	\$ 13.2

#### **Note 6. Supplemental Financial Statement Information**

Cash and cash equivalents at December 31, 2011 and December 31, 2010 were as follows:

<i>(in millions)</i>	<b>2011</b>	<b>2010</b>
Cash	\$ <b>339.6</b>	\$ 256.8
Other short-term investments	<b>41.0</b>	175.5
Total cash and cash equivalents	<b>\$ 380.6</b>	\$ 432.3

Accounts receivable are presented net of a reserve for doubtful accounts of \$5.9 million at December 31, 2011, and \$5.6 million at December 31, 2010. During 2011, the Company recognized expense of \$2.1 million to increase the reserve for doubtful accounts and wrote off \$2.7 million of uncollectible accounts, which reduced the reserve. Additionally, the year end reserve for doubtful accounts includes \$0.9 million acquired as part of the Ladish acquisition. During 2010, the Company recognized expense of \$0.5 million to increase the reserve for doubtful accounts and wrote off \$1.4 million of uncollectible accounts, which decreased the reserve. During 2009, the Company recognized expense of \$1.7 million to increase the reserve for doubtful accounts and wrote off \$1.5 million of uncollectible accounts, which decreased the reserve.

Other intangible assets, which are included in Other assets on the accompanying consolidated balance sheet as of December 31, 2011, were as follows:

<i>(in millions)</i>	<b>Useful life (years)</b>	<b>Gross carrying amount</b>	<b>Accumulated amortization</b>
Technology	20	\$ 74.0	\$ (0.8)
Customer relationships	25	31.0	(2.5)
Total amortizable intangible assets		105.0	(3.3)
Indefinite-lived trademarks		61.0	-
Total intangible assets		<b>\$ 166.0</b>	<b>\$ (3.3)</b>

Amortization expense related to the amortizable intangibles acquired in the Ladish acquisition was approximately \$3.3 million for the year end December 31, 2011. For each of the years ended December 31, 2012 through 2016, annual amortization expense is expected to be \$4.9 million.

Accrued liabilities included salaries, wages and other payroll-related liabilities of \$86.3 million and \$62.4 million at December 31, 2011 and 2010, respectively.

Other income (expense) for the years ended December 31, 2011, 2010, and 2009 was as follows:

<i>(in millions)</i>	<b>2011</b>	2010	2009
Rent, royalty income and other income	\$ 1.3	\$ 1.4	\$ 0.9
Gain (losses) on insured events	<b>(0.2)</b>	2.0	-
Net losses on property and investments	<b>(0.3)</b>	-	(0.2)
Other	<b>(0.2)</b>	(0.4)	-
<b>Total other income</b>	<b>\$ 0.6</b>	\$ 3.0	\$ 0.7

#### **Note 7. Debt**

Debt at December 31, 2011 and December 31, 2010 was as follows:

<i>(In millions)</i>	<b>2011</b>	2010
Allegheny Technologies \$500 million 5.95% Notes due 2021	\$ 500.0	\$ -
Allegheny Technologies \$402.5 million 4.25% Convertible Notes due 2014	402.5	402.5
Allegheny Technologies \$350 million 9.375% Notes due 2019	350.0	350.0
Allegheny Technologies \$300 million 8.375% Notes due 2011, net (a)	-	117.3
Allegheny Ludlum 6.95% debentures due 2025	150.0	150.0
Ladish Series B 6.14% Notes due 2016 (b)	31.8	-
Ladish Series C 6.41% Notes due 2015 (c)	44.6	-
Domestic Bank Group \$400 million unsecured credit agreement	-	-
Promissory note for J&L asset acquisition	-	10.2
Foreign credit agreements	24.5	26.3
Industrial revenue bonds, due through 2020, and other	5.9	7.0
<b>Total short-term and long-term debt</b>	<b>1,509.3</b>	1,063.3
<b>Short-term debt and current portion of long-term debt</b>	<b>27.3</b>	141.4
<b>Total long-term debt</b>	<b>\$ 1,482.0</b>	\$ 921.9

- (a) Includes fair value adjustments for settled interest rate swap contracts of \$0.9 million at December 31, 2010.
- (b) Includes fair value adjustments of \$3.2 million at December 31, 2011.
- (c) Includes fair value adjustments of \$4.6 million at December 31, 2011.

Interest expense was \$93.7 million in 2011, \$63.8 million in 2010, and \$21.4 million in 2009. Interest expense was reduced by \$12.1 million, \$12.5 million, and \$39.0 million, in 2011, 2010, and 2009, respectively, from interest capitalization on capital projects. Interest and commitment fees paid were \$102.8 million in 2011, \$72.8 million in 2010, and \$58.1 million in 2009. Net interest expense includes interest income of \$1.4 million in 2011, \$1.1 million in 2010, and \$2.1 million in 2009.

Scheduled principal payments during the next five years are \$27.3 million in 2012, \$30.7 million in 2013, \$419.3 million in 2014, \$16.9 million in 2015 and \$7.0 million in 2016.

#### 2021 Notes

On January 7, 2011, ATI issued \$500 million of 5.95% Senior Notes due January 15, 2021 (2021 Notes). Interest is payable semi-annually on January 15 and July 15 of each year. The 2021 Notes were issued under ATI's shelf registration statement and are not listed on any national securities exchange. Underwriting fees, discount, and other third-party expenses for the issuance of the 2021 Notes were \$5.0 million and are being amortized to interest expense over the 10-year term of the 2021 Notes. The 2021 Notes are unsecured and unsubordinated obligations of the Company and equally ranked with all of its existing and future senior unsecured debt. The 2021 Notes restrict the Company's ability to create certain liens, to enter into sale leaseback transactions, and to consolidate, merge or transfer all, or substantially all, of its assets. The Company has the option to redeem the 2021 Notes, as a whole or in part, at any time or from time to time, on at least 30 days prior notice to the holders of the 2021 Notes at a redemption price specified in the 2021 Notes. On or after October 15, 2020, the Company may redeem the 2021 Notes at its option, at any time in whole or from time to time in part, at a redemption price equal to 100% of the principal amount of the 2021 Notes to be redeemed, plus accrued and unpaid interest. The 2021 Notes are subject to repurchase upon the occurrence of a change in control repurchase event (as defined in the 2021 Notes) at a repurchase price in cash equal to 101% of the aggregate principal amount of the 2021 Notes repurchased, plus any accrued and unpaid interest.

## Ladish Notes

In conjunction with the Ladish acquisition, the Company assumed the Series B and Series C Notes previously issued by Ladish. The Series B 6.14% Notes are unsecured and have a principal balance of \$28.6 million at December 31, 2011, excluding fair value adjustments. The Series B Notes pay interest semi-annually and mature on May 16, 2016, with the principal amortizing equally in annual payments over the remaining term. The Series C 6.41% Notes are unsecured and have a principal balance of \$40 million at December 31, 2011, excluding fair value adjustments. The Series C Notes pay interest semi-annually and mature on September 2, 2015, with the principal amortizing equally in annual payments over the remaining term. The Series B and Series C Notes contain financial covenants specific to ATI Ladish which (1) limit the incurrence of certain additional debt; (2) require a certain level of consolidated adjusted net worth; (3) require minimum fixed charges coverage ratio; and (4) require a limited amount of funded debt to consolidated cash flow. The covenant on incurrence of additional debt limits funded debt to 60% of total capitalization. ATI Ladish was in compliance with all Series B and Series C covenants at December 31, 2011.

## Convertible Notes

In June 2009, the Company issued and sold \$402.5 million in aggregate principal amount of 4.25% Convertible Senior Notes due 2014 (the "Convertible Notes"). Interest is payable semi-annually on June 1 and December 1 of each year. The Convertible Notes are unsecured and unsubordinated obligations of the Company and rank equally with all of its existing and future senior unsecured debt. The underwriting fees and other third-party expenses for the issuance of the Convertible Notes were \$12.3 million and are being amortized to interest expense over the 5-year term of the Convertible Notes.

The Company does not have the right to redeem the Convertible Notes prior to the stated maturity date. Holders of the Convertible Notes have the option to convert their notes into shares of ATI common stock at any time prior to the close of business on the second scheduled trading day immediately preceding the stated maturity date (June 1, 2014). The initial conversion rate for the Convertible Notes is 23.9263 shares of ATI common stock per \$1,000 (in whole dollars) principal amount of notes (9,630,336 shares), equivalent to a conversion price of approximately \$41.795 per share, subject to adjustment, as defined in the Convertible Notes. Other than receiving cash in lieu of fractional shares, holders do not have the option to receive cash instead of shares of common stock upon conversion. Accrued and unpaid interest that exists upon conversion of a note will be deemed paid by the delivery of shares of ATI common stock and no cash payment or additional shares will be given to holders.

If the Company undergoes a fundamental change, as defined in the Convertible Notes, holders may require the Company to repurchase all or a portion of their notes at a price equal to 100% of the principal amount of the notes to be purchased plus any accrued and unpaid interest up to, but excluding, the repurchase date. Such a repurchase will be made in cash.

## 2011 Notes

In June 2009, the Company completed a tender offer for the Company's 8.375% Notes due in 2011 (the "2011 Notes") of which \$300 million in aggregate principal amount was outstanding prior to the tender offer. As a result of the tender offer, the Company retired \$183.3 million of the 2011 Notes and recognized a pre-tax charge of \$9.2 million in the 2009 second quarter for the costs of acquiring the 2011 Notes. The remaining \$116.7 million in face value of the 2011 Notes was retired upon maturity on December 15, 2011.

The Company had deferred gains on settled interest rate swap contracts that were recognized as reductions to interest expense over the remaining life of the 2011 Notes. At December 31, 2010, the unrecognized deferred settlement gain was \$0.9 million. Interest expense was reduced by \$0.9 million in both 2011 and 2010, and by \$1.3 million in 2009, as a result of the deferred gain amortization.

## Unsecured Credit Agreement

The Company has a \$400 million senior unsecured domestic revolving credit facility that expires in December 2015. The facility includes a \$200 million sublimit for the issuance of letters of credit. Under the terms of the facility, the Company may increase the size of the credit facility by up to \$100 million without seeking the further approval of the lending group. The facility requires the Company to maintain a leverage ratio (consolidated total indebtedness divided by consolidated earnings before interest, taxes and depreciation and amortization) of not greater than 3.25, and maintain an interest coverage ratio (consolidated earnings before interest and taxes divided by interest expense) of not less than 2.0. At December 31, 2011, the leverage ratio was 1.78 and the interest coverage ratio was 5.31. The definition of consolidated earnings before interest and taxes, and consolidated earnings before income, taxes, depreciation and amortization as used in the interest coverage and leverage ratios excludes any non-cash pension expense or income, and consolidated indebtedness in the leverage ratio is net of cash on hand in excess of \$50 million. The Company was in compliance with these required ratios during all applicable periods. As of December 31, 2011,



there had been no borrowings made under the facility, although a portion of the facility was used to support approximately \$7 million in letters of credit.

Borrowings or letter of credit issuance under the unsecured facility bear interest at the Company's option at either: (1) the one-, two-, three- or six-month LIBOR rate plus a margin ranging from 1.50% to 2.25% depending upon the value of the leverage ratio as defined by the unsecured facility agreement; or (2) a base rate announced from time-to-time by the lending group (i.e., the Prime lending rate). In addition, the unsecured facility contains a facility fee of 0.25% to 0.50% depending upon the value of the leverage ratio. The Company's overall borrowing costs under the unsecured facility are not affected by changes in the Company's credit ratings.

#### Foreign and Other Credit Facilities

The Company has an additional separate credit facility for the issuance of letters of credit. As of December 31, 2011, \$31 million in letters of credit were outstanding under this facility.

STAL, the Company's Chinese joint venture company in which ATI has a 60% interest, has a revolving credit facility with a group of banks that expires in 2012. Under the credit facility, STAL may borrow up to 205 million renminbi (approximately \$32 million based on December 2011 exchange rates) at an interest rate equal to 90% of the applicable lending rate published by the People's Bank of China. The credit facility is supported solely by STAL's financial capability without any guarantees from the joint venture partners, and is intended to be utilized in the future to support the expansion of STAL's operations, which are located in Shanghai, China. The credit facility requires STAL to maintain a minimum level of shareholders' equity, and certain financial ratios. As of December 31, 2011, there had been no borrowings made under the STAL credit facility.

The Company's subsidiaries also maintain other credit agreements with various foreign banks, which provide for borrowings of up to approximately \$37 million, including \$11 million of short-term financing of trade accounts payable at STAL. At December 31, 2011, the Company had approximately \$13 million of available borrowing capacity under these foreign credit agreements. These agreements provide for annual facility fees of up to 0.20%. The weighted average interest rate of foreign credit agreements as of December 31, 2011, was 1.60%.

The Company has no off-balance sheet financing relationships as defined in Item 303(a)(4) of SEC Regulation S-K, with variable interest entities, structured finance entities, or any other unconsolidated entities. At December 31, 2011, the Company had not guaranteed any third-party indebtedness.

#### **Note 8. Derivative Financial Instruments and Hedging**

As part of its risk management strategy, the Company, from time-to-time, utilizes derivative financial instruments to manage its exposure to changes in raw material prices, energy costs, foreign currencies, and interest rates. In accordance with applicable accounting standards, the Company accounts for all of these contracts as hedges. In general, hedge effectiveness is determined by examining the relationship between offsetting changes in fair value or cash flows attributable to the item being hedged, and the financial instrument being used for the hedge. Effectiveness is measured utilizing regression analysis and other techniques to determine whether the change in the fair market value or cash flows of the derivative exceeds the change in fair value or cash flow of the hedged item. Calculated ineffectiveness, if any, is immediately recognized on the statement of income.

The Company sometimes uses futures and swap contracts to manage exposure to changes in prices for forecasted purchases of raw materials, such as nickel, and natural gas. Generally under these contracts, which are accounted for as cash flow hedges, the price of the item being hedged is fixed at the time that the contract is entered into and the Company is obligated to make or receive a payment equal to the net change between this fixed price and the market price at the date the contract matures.

The majority of ATI's products are sold utilizing raw material surcharges and index mechanisms. However, as of December 31, 2011, the Company had entered into financial hedging arrangements primarily at the request of its customers, related to firm orders, for an aggregate notional amount of less than 9% of the Company's estimated annual nickel requirements. These nickel hedges extend to 2016.

At December 31, 2011, the outstanding financial derivatives used to hedge the Company's exposure to energy cost volatility included natural gas cost hedges for approximately 70% of its annual forecasted domestic requirements for 2012, 50% for 2013 and approximately 10% for 2014, and electricity hedges for Western Pennsylvania operations of approximately 30% of its forecasted on-peak and off-peak requirements for 2012.

While the majority of the Company's direct export sales are transacted in U.S. dollars, foreign currency exchange contracts are used, from time-to-time, to limit transactional exposure to changes in currency exchange rates for those transactions denominated in a non-U.S. currency. The Company sometimes purchases foreign currency forward contracts that permit it to sell specified amounts of foreign currencies expected to be received from its export sales for pre-established U.S. dollar amounts at specified dates. The forward contracts are denominated in the same foreign currencies in which export sales are denominated. These contracts are designated as hedges of the variability in cash flows of a portion of the forecasted future export sales transactions which otherwise would expose the Company to foreign currency risk. At December 31, 2011, the outstanding financial derivatives used to hedge the Company's exposure to foreign currency, primarily euros, represented approximately 10% of the Company's forecasted total international sales through 2013. In addition, the Company may also designate cash balances held in foreign currencies as hedges of forecasted foreign currency transactions.

The Company may enter into derivative interest rate contracts to maintain a reasonable balance between fixed- and floating-rate debt. There were no unsettled derivative financial instruments related to debt balances for the periods presented.

The fair values of the Company's derivative financial instruments are presented below. All fair values for these derivatives were measured using Level 2 information as defined by the accounting standard hierarchy, which includes quoted prices for similar assets or liabilities in active markets, quoted prices for identical or similar assets or liabilities in markets that are not active, and inputs derived principally from or corroborated by observable market data.

<i>(in millions):</i>		December 31,	December 31,
Asset derivatives	Balance sheet location	2011	2010
Derivatives designated as hedging instruments:			
Foreign exchange contracts	Prepaid expenses and other current assets	\$ 9.5	\$ 10.0
Nickel and other raw material contracts	Prepaid expenses and other current assets	0.7	3.7
Electricity contracts	Prepaid expenses and other current assets	-	0.4
Foreign exchange contracts	Other assets	5.9	0.5
Nickel and other raw material contracts	Other assets	1.1	0.8
Electricity contracts	Other assets	-	0.2
Natural gas contracts	Other assets	-	0.3
Total derivatives designated as hedging instruments:		17.2	15.9
Derivatives not designated as hedging instruments:			
Foreign exchange contracts	Prepaid expenses and other current assets	3.5	4.2
Total derivatives not designated as hedging instruments:		3.5	4.2
Total asset derivatives		\$ 20.7	\$ 20.1
Liability derivatives	Balance sheet location		
Derivatives designated as hedging instruments:			
Natural gas contracts	Accrued liabilities	\$ 10.1	\$ 16.7
Nickel and other raw material contracts	Accrued liabilities	1.6	-
Foreign exchange contracts	Accrued liabilities	-	2.0
Electricity contracts	Accrued liabilities	2.0	0.8
Natural gas contracts	Other long-term liabilities	3.3	0.8
Electricity contracts	Other long-term liabilities	-	0.5
Foreign exchange contracts	Other long-term liabilities	-	1.1
Nickel and other raw material contracts	Other long-term liabilities	0.1	-
Total liability derivatives		\$ 17.1	\$ 21.9

For derivative financial instruments that are designated as cash flow hedges, the effective portion of the gain or loss on the derivative is reported as a component of other comprehensive income (OCI) and reclassified into earnings in the same period or periods during which the hedged item affects earnings. Gains and losses on the derivative representing either hedge ineffectiveness or hedge components excluded from the assessment of effectiveness are recognized in current period results. The Company did not use fair value or net investment hedges for the periods presented. The effects of derivative instruments in the tables below are presented net of related income taxes.

Activity with regard to derivatives designated as cash flow hedges for the year ended December 31, 2011 were as follows (in millions):

Derivatives in Cash Flow Hedging Relationships	Amount of Gain (Loss) Recognized in OCI on Derivatives (Effective Portion)		Amount of Gain (Loss) Reclassified from Accumulated OCI into Income (Effective Portion) (a)		Amount of Gain (Loss) Recognized in Income on Derivatives (Ineffective Portion and Amount Excluded from Effectiveness Testing) (b)	
	2011	2010	2011	2010	2011	2010
Nickel and other raw material contracts	\$ (5.9)	\$ 6.6	\$ (3.1)	\$ 13.3	\$ -	\$ -
Natural gas contracts	(10.1)	(10.7)	(12.5)	(10.6)	-	-
Electricity contracts	(1.1)	(0.4)	(0.3)	-	-	-
Foreign exchange contracts	5.2	10.1	0.2	10.1	-	-
<b>Total</b>	<b>\$ (11.9)</b>	<b>\$ 5.6</b>	<b>\$ (15.7)</b>	<b>\$ 12.8</b>	<b>\$ -</b>	<b>\$ -</b>

- (a) The gains (losses) reclassified from accumulated OCI into income related to the effective portion of the derivatives are presented in cost of sales.
- (b) The gains (losses) recognized in income on derivatives related to the ineffective portion and the amount excluded from effectiveness testing are presented in selling and administrative expenses.

Assuming market prices remain constant with those at December 31, 2011, a loss of \$2.1 million is expected to be recognized over the next 12 months.

The disclosures of gains or losses presented above for nickel and other raw material contracts and foreign currency contracts do not take into account the anticipated underlying transactions. Since these derivative contracts represent hedges, the net effect of any gain or loss on results of operations may be fully or partially offset.

Derivatives that are not designated as hedging instruments were as follows:

<i>(In millions)</i>	Amount of Gain (Loss) Recognized in Income on Derivatives	
	2011	2010
Derivatives Not Designated as Hedging Instruments		
Foreign exchange contracts	\$ -	\$ 2.8

Changes in the fair value of foreign exchange contract derivatives not designated as hedging instruments are recorded in cost of sales.

There are no credit risk-related contingent features in the Company's derivative contracts, and the contracts contained no provisions under which the Company has posted, or would be required to post, collateral. The counterparties to the Company's derivative contracts were substantial and creditworthy commercial banks that are recognized market makers. The Company controls its credit exposure by diversifying across multiple counterparties and by monitoring credit ratings and credit default swap spreads of its counterparties. The Company also enters into master netting agreements with counterparties when possible.

## Note 9. Fair Value of Financial Instruments

The estimated fair value of financial instruments at December 31, 2011 was as follows:

<i>(In millions)</i>	Total Carrying Amount	Fair Value Measurements at Reporting Date Using		
		Total Estimated Fair Value	Quoted Prices in Active Markets for Identical Assets (Level 1)	Significant Observable Inputs (Level 2)
Cash and cash equivalents	\$ 380.6	\$ 380.6	\$ 380.6	\$ -
Derivative financial instruments:				
Assets	20.7	20.7	-	20.7
Liabilities	17.1	17.1	-	17.1
Debt	1,509.3	1,791.3	1,684.5	106.8

The estimated fair value of financial instruments at December 31, 2010 was as follows:

<i>(In millions)</i>	Total Carrying Amount	Fair Value Measurements at Reporting Date Using		
		Total Estimated Fair Value	Quoted Prices in Active Markets for Identical Assets (Level 1)	Significant Observable Inputs (Level 2)
Cash and cash equivalents	\$ 432.3	\$ 432.3	\$ 432.3	\$ -
Derivative financial instruments:				
Assets	20.1	20.1	-	20.1
Liabilities	21.9	21.9	-	21.9
Debt (a)	1,063.3	1,328.4	1,284.9	43.5

(a) Includes fair value adjustments for settled interest rate swap contracts of \$0.9 million at December 31, 2010.

In accordance with accounting standards, fair value is defined as the exchange price that would be received for an asset or paid to transfer a liability (an exit price) in the principal or most advantageous market for the asset or liability in an orderly transaction between market participants at the measurement date. Accounting standards established three levels of a fair value hierarchy that prioritizes the inputs used to measure fair value. This hierarchy requires entities to maximize the use of observable inputs and minimize the use of unobservable inputs. The three levels of inputs used to measure fair value are as follows:

Level 1 – Quoted prices in active markets for identical assets or liabilities.

Level 2 – Observable inputs other than quoted prices included in Level 1, such as quoted prices for similar assets and liabilities in active markets; quoted prices for identical or similar assets and liabilities in markets that are not active; or other inputs that are observable or can be corroborated by observable market data.

Level 3 – Unobservable inputs that are supported by little or no market activity and that are significant to the fair value of the assets and liabilities. This includes certain pricing models, discounted cash flow methodologies and similar techniques that use significant unobservable inputs.

The following methods and assumptions were used by the Company in estimating the fair value of its financial instruments:

Cash and cash equivalents: Fair values were determined using Level 1 information.

Derivative financial instruments: Fair values for derivatives were measured using exchange-traded prices for the hedged items. The fair value was determined using Level 2 information, including consideration of counterparty risk and the Company's credit risk.

Short-term and long-term debt: The fair values of the Allegheny Technologies 4.25% Convertible Notes, the Allegheny Technologies 9.375% Notes, the Allegheny Technologies 5.95% Notes, the Allegheny Technologies 8.375% Notes, and the Allegheny Ludlum 6.95% debentures were determined using Level 1 information. The fair values of the other short-term and long-term debt were determined using Level 2 information.



## Note 10. Pension Plans and Other Postretirement Benefits

The Company has defined benefit pension plans and defined contribution plans covering substantially all employees. Benefits under the defined benefit pension plans are generally based on years of service and/or final average pay. The Company funds the U.S. pension plans in accordance with the Employee Retirement Income Security Act of 1974, as amended, and the Internal Revenue Code.

The Company also sponsors several postretirement plans covering certain salaried and hourly employees. The plans provide health care and life insurance benefits for eligible retirees. In most plans, Company contributions towards premiums are capped based on the cost as of a certain date, thereby creating a defined contribution. For the non-collectively bargained plans, the Company maintains the right to amend or terminate the plans at its discretion.

The components of pension and other postretirement benefit expense for the Company's defined benefit plans included the following:

<i>(in millions)</i>	Pension Benefits			Other Postretirement Benefits		
	2011	2010	2009	2011	2010	2009
Service cost - benefits earned during the year	\$ 30.0	\$ 30.2	\$ 23.3	\$ 3.2	\$ 3.1	\$ 2.9
Interest cost on benefits earned in prior years	135.1	131.9	138.6	27.5	28.9	32.5
Expected return on plan assets	(192.1)	(181.5)	(156.4)	(1.0)	(1.4)	(1.5)
Amortization of prior service cost (credit)	11.3	13.4	16.6	(18.3)	(18.1)	(19.2)
Amortization of net actuarial loss	71.3	77.4	76.5	9.9	6.0	6.4
Termination benefits	0.8	-	-	0.2	-	-
Total retirement benefit expense	\$ 56.4	\$ 71.4	\$ 98.6	\$ 21.5	\$ 18.5	\$ 21.1

Special termination benefits were recorded in 2011 in conjunction with the temporary idling of the Flat-Rolled Products segment's New Castle, IN finishing facility.

Actuarial assumptions used to develop the components of defined benefit pension expense and other postretirement benefit expense were as follows:

	Pension Benefits			Other Postretirement Benefits		
	2011	2010	2009	2011	2010	2009
Discount rate (a)	5.45 - 5.8%	6.20%	6.85 - 7.5%	5.45 - 5.8%	6.20%	6.85%
Rate of increase in future compensation levels	2.5 - 4.5%	2.5 - 4.5%	3 - 4.5%	-	-	-
Expected long-term rate of return on assets	8.50%	8.75%	8.75%	8.3%	8.3%	8.3%

(a) Pension and other postretirement benefit expense for 2011 was initially measured at a 5.8% discount rate. The Ladish pension and other postretirement benefit plans acquired May 9, 2011 were valued using a 5.45% discount rate. Certain other postretirement benefit plan obligations were remeasured as of August 1, 2011 using a 5.5% discount rate as a result of benefit changes. The 2009 expense for the U.S. qualified defined benefit plan initially used a 6.85% discount rate. This plan was remeasured in the second quarter 2009 upon the Company's \$350 million voluntary cash contribution, and a 7.5% discount rate was used to determine expense for this plan for the remainder of the year.

Actuarial assumptions used for the valuation of defined benefit pension and other postretirement benefit obligations at the end of the respective periods were as follows:

	Pension Benefits		Other Postretirement Benefits	
	2011	2010	2011	2010
Discount rate	5.0%	5.8%	5.0%	5.8%
Rate of increase in future compensation levels	3.0% - 4.5%	2.5% - 4.5%	-	-

A reconciliation of the funded status for the Company's defined benefit pension and other postretirement benefit plans at December 31, 2011 and 2010 was as follows:

<i>(in millions)</i>	Pension Benefits		Other Postretirement Benefits	
	2011	2010	2011	2010
<b>Change in benefit obligations:</b>				
Benefit obligation at beginning of year	\$ 2,293.6	\$ 2,220.7	\$ 499.6	\$ 509.4
Service cost	30.0	30.2	3.2	3.1
Interest cost	135.1	131.9	27.5	28.9
Benefits paid	(186.9)	(176.9)	(56.1)	(53.5)
Subsidy paid	-	-	1.4	2.1
Participant contributions	0.7	0.7	-	-
Acquisition	210.7	-	32.3	-
Effect of currency rates	0.8	(2.7)	-	-
Benefit changes	2.3	-	3.4	-
Net actuarial (gains) losses - discount rate change	216.3	94.3	22.2	15.1
- other	46.9	(4.6)	34.9	(5.5)
Special termination benefits	0.8	-	0.2	-
Benefit obligation at end of year	\$ 2,750.3	\$ 2,293.6	\$ 568.6	\$ 499.6
<b>Change in plan assets:</b>				
Fair value of plan assets at beginning of year	\$ 2,237.4	\$ 2,163.5	\$ 12.5	\$ 17.1
Actual returns on plan assets and plan expenses	1.8	244.7	1.5	(0.4)
Employer contributions	8.4	7.5	-	-
Participant contributions	0.7	0.7	-	-
Acquisition	170.6	-	-	-
Effect of currency rates	0.7	(2.1)	-	-
Benefits paid	(186.9)	(176.9)	(5.2)	(4.2)
Fair value of plan assets at end of year	\$ 2,232.7	\$ 2,237.4	\$ 8.8	\$ 12.5
<b>Amounts recognized in the balance sheet:</b>				
Other assets	\$ -	\$ 8.7	\$ -	\$ -
Current liabilities	(8.7)	(6.6)	(71.7)	(63.3)
Noncurrent liabilities	(508.9)	(58.3)	(488.1)	(423.8)
Total amount recognized	\$ (517.6)	\$ (56.2)	\$ (559.8)	\$ (487.1)

Changes to accumulated other comprehensive loss related to pension and other postretirement benefit plans in 2011 and 2010 were as follows:

<i>(in millions)</i>	Pension Benefits		Other Postretirement Benefits	
	2011	2010	2011	2010
Beginning of year accumulated other comprehensive loss	\$ (969.8)	\$ (1,035.2)	\$ (90.0)	\$ (66.6)
Amortization of net actuarial loss	71.3	77.4	9.9	6.0
Amortization of prior service cost (credit)	11.3	13.4	(18.3)	(18.1)
Remeasurements	(456.1)	(25.4)	(60.2)	(11.3)
End of year accumulated other comprehensive loss	\$ (1,343.3)	\$ (969.8)	\$ (158.6)	\$ (90.0)
Net change in accumulated other comprehensive loss	\$ (373.5)	\$ 65.4	\$ (68.6)	\$ (23.4)

Amounts included in accumulated other comprehensive loss at December 31, 2011 and 2010 were as follows:

<i>(in millions)</i>	Pension Benefits		Other Postretirement Benefits	
	2011	2010	2011	2010
Prior service (cost) credit	\$ (17.2)	\$ (26.2)	\$ 27.7	\$ 49.4
Net actuarial loss	(1,326.1)	(943.6)	(186.3)	(139.4)
Accumulated other comprehensive loss	(1,343.3)	(969.8)	(158.6)	(90.0)
Deferred tax effect	508.7	369.6	60.6	34.7
Accumulated other comprehensive loss, net of tax	\$ (834.6)	\$ (600.2)	\$ (98.0)	\$ (55.3)

Retirement benefit expense for defined benefit plans in 2012 is estimated to be approximately \$122 million, comprised of \$98 million for pension expense and \$24 million of expense for other postretirement benefits. Amounts in accumulated other comprehensive income (loss) that are expected to be recognized as components of net periodic benefit cost in 2012 are:

<i>(in millions)</i>	Pension	Other	Total
	Benefits	Postretirement Benefits	
Amortization of prior service cost (credit)	\$ 6.4	\$ (18.2)	\$ (11.8)
Amortization of net actuarial loss	105.2	14.5	119.7
Amortization of accumulated other comprehensive income (loss)	\$ 111.6	\$ (3.7)	\$ 107.9

The accumulated benefit obligation for all defined benefit pension plans was \$2,677.2 million and \$2,239.4 million at December 31, 2011 and 2010, respectively. Additional information for pension plans with accumulated benefit obligations in excess of plan assets:

<i>(in millions)</i>	Pension Benefits	
	2011	2010
Projected benefit obligation	\$ 2,750.3	\$ 123.2
Accumulated benefit obligation	2,677.2	119.1
Fair value of plan assets	2,232.7	58.3

Based upon current regulations and actuarial studies, the Company does not expect to be required to make cash contributions to its U.S. qualified defined benefit pension plan (U.S. Plan) for 2012. However, the Company may elect, depending upon the investment performance of the pension plan assets and other factors, to make voluntary cash contributions to this pension plan in the future. For 2012, the Company expects to fund benefits of approximately \$9 million for its U.S. nonqualified benefit pension plans and its U.K. defined benefit plan.

The following table summarizes expected benefit payments from the Company's various pension and other postretirement benefit defined benefit plans through 2021, and also includes estimated Medicare Part D subsidies projected to be received during this period based on currently available information.

<i>(in millions)</i>	Pension	Other	Medicare Part
	Benefits	Postretirement Benefits	D Subsidy
2012	\$ 181.6	\$ 73.8	\$ 1.7
2013	180.2	56.3	1.7
2014	179.1	55.0	1.7
2015	179.8	53.5	1.7
2016	180.0	50.3	1.6
2017-2021	893.6	213.0	7.3

The annual assumed rate of increase in the per capita cost of covered benefits (the health care cost trend rate) for health care plans was 9.1% in 2012 and is assumed to gradually decrease to 5.0% in the year 2028 and remain at that level thereafter.

Assumed health care cost trend rates have a significant effect on the amounts reported for the health care plans. A one percentage point change in assumed health care cost trend rates would have the following effects:

<i>(in millions)</i>	One Percentage Point Increase	One Percentage Point Decrease
Effect on total of service and interest cost components for the year ended December 31, 2011	\$ 0.5	\$ (0.6)
Effect on other postretirement benefit obligation at December 31, 2011	\$ 14.3	\$ (12.6)

The plan assets for the U.S. Plan represent approximately 97% of total pension plan assets at December 31, 2011. In December 2011, the qualified defined benefit pension plans of ATI Ladish were merged into the U.S. Plan. The U.S. Plan invests in a diversified portfolio consisting of an array of asset classes that attempts to maximize returns while minimizing volatility. These asset classes include U.S. domestic equities, developed market equities, emerging market equities, private equity, global high quality and high yield fixed income, and real estate. The Company continually monitors the investment results of these asset classes and its fund managers, and explores other potential asset classes for possible future investment.

U.S. Plan assets at December 31, 2011 and 2010 included 3.0 million shares and 2.8 million shares, respectively of ATI common stock with a fair value of \$141.2 million and \$154.5 million, respectively. Shares of ATI stock held by the U.S. Plan increased in 2011 due to the merger of the ATI Ladish plans. Dividends of \$2.1 million and \$2.0 million were received by the U.S. Plan in 2011 and 2010, respectively, on the ATI common stock held by this plan.

The fair values of the Company's pension plan assets at December 31, 2011 by asset category and by the level of inputs used to determine fair value, were as follows:

<i>(in millions)</i>	Total	Quoted Prices in Active Markets for Identical Assets (Level 1)	Significant Observable Inputs (Level 2)	Significant Unobservable Inputs (Level 3)
Equity securities:				
ATI common stock	\$ 141.2	\$ 141.2	\$ -	\$ -
Other U.S. equities (a)	513.7	168.2	345.5	-
International equities (b)	222.9	21.6	201.3	-
Fixed income and cash equivalents (c)	1,050.5	221.2	827.4	1.9
Private equity	80.6	-	-	80.6
Hedge funds	121.9	-	-	121.9
Real estate and other	101.9	4.6	7.9	89.4
<b>Total assets</b>	<b>\$ 2,232.7</b>	<b>\$ 556.8</b>	<b>\$ 1,382.1</b>	<b>\$ 293.8</b>

(a) Includes investments in comingled funds that invest in U.S. equity securities, comprised of approximately 90% large-cap U.S. companies and 10% small-cap U.S. companies.

(b) Includes investments in comingled funds that invest in non-U.S. equity securities, comprised of approximately 80% developed countries and 20% emerging market economies.

(c) Fixed income investments are comprised of actively managed investments which include U.S. government and U.S. government agency securities, corporate bonds, mortgage-backed securities and other fixed income securities. To mitigate risk, investment managers have limitations regarding the amount of investment in particular securities and the credit quality of such investments.

The fair values of the Company's pension plan assets at December 31, 2010 by asset category and by the level of inputs used to determine fair value, were as follows:

<i>(in millions)</i>		Quoted Prices in Active Markets for Identical Assets	Significant Observable Inputs	Significant Unobservable Inputs
<b>Asset category</b>	Total	(Level 1)	(Level 2)	(Level 3)
Equity securities:				
ATI common stock	\$ 154.5	\$ 154.5	\$ -	\$ -
Other U.S. equities (a)	519.3	185.2	334.1	-
International equities (b)	266.7	21.5	245.2	-
Fixed income and cash equivalents (c)	1,020.3	150.6	867.3	2.4
Private equity	83.0	-	-	83.0
Hedge funds	124.0	-	-	124.0
Real estate and other	69.6	4.2	8.6	56.8
<b>Total assets</b>	<b>\$ 2,237.4</b>	<b>\$ 516.0</b>	<b>\$ 1,455.2</b>	<b>\$ 266.2</b>

- (a) Includes investments in comingled funds that invest in U.S. equity securities, comprised of approximately 90% large-cap U.S. companies and 10% small-cap U.S. companies.
- (b) Includes investments in comingled funds that invest in non-U.S. equity securities, comprised of approximately 80% developed countries and 20% emerging market economies.
- (c) Fixed income investments are comprised of actively managed investments which include U.S. government and U.S. government agency securities, corporate bonds, mortgage-backed securities and other fixed income securities. To mitigate risk, investment managers have limitations regarding the amount of investment in particular securities and the credit quality of such investments.

Changes in the fair value of Level 3 pension plan assets for the year ended December 31, 2011 were as follows:

<i>(in millions)</i>	January 1, 2011 Balance	Net Realized and Unrealized Gains (Losses)	Net Purchases, Issuances and Settlements	Net Transfers Into (Out Of) Level 3	December 31, 2011 Balance
Fixed income and cash equivalents	\$ 2.4	\$ 0.3	\$ (0.8)	\$ -	\$ 1.9
Private equity	83.0	-	(0.6)	-	82.4
Hedge funds	124.0	(2.1)	-	-	121.9
Real estate and other	56.8	11.0	19.8	-	87.6
<b>Total</b>	<b>\$ 266.2</b>	<b>\$ 9.2</b>	<b>\$ 18.4</b>	<b>\$ -</b>	<b>\$ 293.8</b>

A financial instrument's categorization within the valuation hierarchy is based upon the lowest level of input that is significant to the fair value measurement. Investments in U.S. and International equities, and Fixed Income are predominantly held in common/collective trust funds and registered investment companies. These investments are public investment vehicles valued using the net asset value (NAV) provided by the administrator of the fund. The NAV is based on the value of the underlying assets owned by the fund, minus its liabilities, and then divided by the number of shares outstanding. In certain cases NAV is a quoted price in a market that is not active, and valuation is based on quoted prices for similar assets and liabilities in active markets, and these investments are classified within level 2 of the valuation hierarchy. Investments that are not actively traded, such as non-publicly traded real estate funds, are classified within level 3 of the valuation hierarchy, as the NAV is based on significant unobservable information.

Hedge fund investments are made as either (1) as a limited partner in a portfolio of underlying hedge funds managed by a general partner or (2) through commingled institutional funds (CIFs) that in-turn invest in various portfolios of hedge funds whereby the allocation of the Plan's investments to each CIF is managed by a third party Investment Manager. All hedge fund investments are classified within level 3 of the valuation hierarchy, as the valuations are substantially based on unobservable information.

Private equity investments include both Direct Funds and Fund-of-Funds. All private equity investments are classified as Level 3 in the valuation hierarchy, as the valuations are substantially based upon unobservable information. Direct Funds are investments in Limited Partnership (LP) interests. Fund-of-Funds are investments in private equity funds that invest in other private equity funds or LPs.



For certain investments classified as Level 3 which have formal financial valuations reported on a one-quarter lag, fair value is determined utilizing net asset values adjusted for subsequent cash flows, estimated financial performance and other significant events.

For 2012, the expected long-term rate of returns on defined benefit pension assets will be 8.5%. In developing the expected long-term rate of return assumptions, the Company evaluated input from its third party pension plan asset managers and actuaries, including reviews of their asset class return expectations and long-term inflation assumptions. The expected long-term rate of return is based on expected asset allocations within ranges for each investment category, and includes consideration of both historical and projected annual compound returns, weighted on a 65%/35% basis, respectively. The Company's actual returns on pension assets for the last five years have been 0.3% for 2011, 12.2% for 2010, 16.4% for 2009, (25.3)% for 2008, and 10.9% for 2007.

The target asset allocations for pension plans for 2012, by major investment category, are:

<b>Asset category</b>	<b>Target asset allocation range</b>
Equity securities:	
U. S. equities	18% - 38%
International equities	7% - 17%
Fixed income	35% - 45%
Private equity	0% - 10%
Hedge funds	0% - 10%
Real estate and other	0% - 10%
Cash and cash equivalents	0% - 10%

At December 31, 2011, other postretirement benefit plan assets of \$9 million are primarily invested in private equity investments, which are classified as Level 3 in the valuation hierarchy, as the valuations are substantially based upon unobservable information. For 2012, the expected long-term rate of returns on these other postretirement benefit assets will be 8.3%. The expected return on other postretirement benefit plan assets is expected to be lower than the return on pension plan investments due to the mix of investments and the expected reduction of plan assets due to benefit payments.

Pension costs for defined contribution plans were \$21.6 million in 2011, \$18.8 million in 2010, and \$18.0 million in 2009. Company contributions to these defined contribution plans are funded with cash.

Labor agreements with United Steelworkers' represented employees require the Company to make contributions to VEBA trusts based upon the attainment of a certain level of profitability. The Company expects to contribute approximately \$24 million of contributions tied to profitability levels to these VEBA trusts in 2012.

The Company contributes to several multiemployer defined benefit pension plans under collective bargaining agreements that cover certain of its union-represented employees. The risks of participating in such plans are different from the risks of single-employer plans, in the following respects:

- a) Assets contributed to a multiemployer plan by one employer may be used to provide benefits to employees of other participating employers.
- b) If a participating employer ceases to contribute to the plan, the unfunded obligations of the plan may be borne by the remaining participating employers.
- c) If the Company ceases to have an obligation to contribute to the multiemployer plan in which it had been a contributing employer, it may be required to pay to the plan an amount based on the underfunded status of the plan and on the history of the Company's participation in the plan prior to the cessation of its obligation to contribute. The amount that an employer that has ceased to have an obligation to contribute to a multiemployer plan is required to pay to the plan is referred to as a withdrawal liability.

The Company's participation in multiemployer plans for the years ended December 31, 2011, 2010 and 2009 is reported in the following table. Participation with regard to multiemployer plans involving ATI Ladish is included from the May 9, 2011 acquisition date.

Pension Fund	EIN / Pension Plan Number	Pension Protection Act			FIP / RP Status Pending / Implemented (2)	<i>in millions</i>			Surcharge Imposed (3)	Expiration Dates of Collective Bargaining Agreements
		Zone Status (1)		Company Contributions						
		2011	2010	2011		2010	2009			
Steelworkers Western Independent Shops Pension Plan	90-0169564 / 001	Red	Red	Yes	\$ 1.2	\$ 0.9	\$ 1.0	No	6/30/2015	
Boilermakers-Blacksmiths National Pension Trust	48-6168020 / 001	Yellow	N/A	Yes	1.2	-	-	No	10/30/2018	
IAM National Pension Fund	51-6031295 / 002	Green	Green	No	1.1	-	-	No	Various between 2014-2019 (4)	
Total contributions					\$ 3.5	\$ 0.9	\$ 1.0			

- (1) The most recent Pension Protection Act Zone Status available for ATI's fiscal years 2011 and 2010 is for plan years ending in calendar years 2010 and 2009, respectively. The zone status is based on information provided to ATI and other participating employers by each plan and is certified by the plan's actuary. A plan in the "red" zone had been determined to be in "critical status", based on criteria established by the Internal Revenue Code ("Code"), and is generally less than 65% funded. A plan in the "yellow" zone has been determined to be in "endangered status", based on criteria established under the Code, and is generally less than 80% funded. A plan in the "green" zone has been determined to be neither in "critical status" nor in "endangered status", and is generally at least 80% funded.
- (2) The "FIP / FP status Pending / Implemented" column indicates whether a Funding Improvement Plan, as required under the Code by plans in the "yellow" zone, or a Rehabilitation Plan, as required under the Code to be adopted by plans in the "red" zone, is pending or has been implemented as of the end of the plan year that ended in 2011.
- (3) The "Surcharge Imposed" column indicates whether ATI's contribution rate for 2011 included an amount in addition to the contribution rate specified in the applicable collective bargaining agreement, as imposed by a plan in "critical status", in accordance with the requirements of the Code.
- (4) The Company is party to six separate bargaining agreements that require contributions to this plan. Expiration dates of these collective bargaining agreements range between July 14, 2014 and July 14, 2019.

The Company's contributions to the Steelworkers Western Independent Shops Pension Plan exceeds 5% of this plan's total contributions for the most recent fiscal year.

#### Note 11. Accumulated Other Comprehensive Income (Loss)

The components of accumulated other comprehensive income (loss), net of tax, at December 31, 2011 and 2010 were as follows:

<i>(in millions)</i>	2011	2010
<b>Attributable to ATI</b>		
Pension plans and other postretirement benefits	\$ (932.6)	\$ (655.5)
Foreign currency translation	(9.0)	(5.9)
Equity securities	(0.1)	-
Derivative financial instruments	0.1	(3.7)
Accumulated other comprehensive income (loss) attributable to ATI	\$ (941.6)	\$ (665.1)
<b>Attributable to noncontrolling interests</b>		
Foreign currency translation	\$ 21.8	\$ 16.0
Accumulated other comprehensive income attributable to noncontrolling interests	\$ 21.8	\$ 16.0

Other comprehensive income (loss) amounts are net of applicable income tax expense (benefit) for each year presented. Foreign currency translation adjustments, including those pertaining to noncontrolling interests, are generally not adjusted for income taxes as they relate to indefinite investments in non-U.S. subsidiaries.

## Note 12. Stockholders' Equity

### Preferred Stock

Authorized preferred stock may be issued in one or more series, with designations, powers and preferences as shall be designated by the Board of Directors. At December 31, 2011, there were no shares of preferred stock issued.

### Common Stock

On November 1, 2007, the Company's Board of Directors approved a share repurchase program of \$500 million. In September 2011, the Board of Directors terminated this share repurchase program. Under the program, a total of 6,837,000 shares had been purchased in open market transactions at a cost of \$339.5 million. There were no share repurchases under this program in 2011, 2010, or 2009.

### Share-based Compensation

The Company sponsors three principal share-based incentive compensation programs. During 2007, the Company adopted the Allegheny Technologies Incorporated 2007 Incentive Plan (the "Incentive Plan"), which was amended and restated in 2010. Awards earned under share-based incentive compensation programs are generally paid with shares held in treasury, if sufficient treasury shares are held, and any additional required share payments are made with newly issued shares. At December 31, 2011, approximately 1.0 million shares of common stock were available for future awards under the Incentive Plan. The general terms of each arrangement granted under the Incentive Plan, and predecessor plans, the method of estimating fair value for each arrangement, and award activity is reported below.

**Stock option awards:** The Company ceased granting stock options to employees in 2003 and to non-employee directors in 2006. As of December 31, 2011, there were no unvested stock option awards.

Stock option transactions under the Company's plans for the years ended December 31, 2011, 2010, and 2009 are summarized as follows:

	2011		2010		2009	
<i>(shares in thousands)</i>	Number of shares	Weighted Average Exercise Price	Number of shares	Weighted Average Exercise Price	Number of shares	Weighted Average Exercise Price
Outstanding, beginning of year	600	\$ 8.11	701	\$ 9.01	823	\$ 9.96
Granted	-	-	-	-	-	-
Exercised	(171)	9.53	(98)	14.21	(76)	11.43
Cancelled	(2)	16.52	(3)	18.09	(46)	21.99
Outstanding at end of year	427	\$ 7.51	600	\$ 8.11	701	\$ 9.01
Exercisable at end of year	427	\$ 7.51	600	\$ 8.11	701	\$ 9.01

Options outstanding at December 31, 2011 were as follows:

<i>(shares in thousands, life in years)</i>	Options Outstanding and Exercisable		
	Number of Shares	Weighted Average Remaining Contractual Life	Weighted Average Exercise Price
\$ 3.63 - \$7.00	214	1.1	\$ 4.16
7.01 - 10.00	164	0.8	7.26
10.01 - 15.00	16	1.0	10.68
15.01 - 20.00	23	0.2	16.30
20.01 - 30.00	3	3.3	24.38
30.01 - 72.46	7	4.3	72.46
	427	1.0	\$ 7.51

The aggregate intrinsic value of options outstanding and exercisable as of December 31, 2011 was \$17.2 million. The aggregate intrinsic value represents the total pre-tax intrinsic value (the difference between the Company's closing stock price on the last trading day of the fourth quarter of fiscal 2011 and the exercise price, multiplied by the number of in-the-money options) that would have been received by the option holders had all option holders exercised their options on December 31, 2011.

**Nonvested stock awards:** Awards of nonvested stock are granted to employees, with either performance and/or service conditions. Awards of nonvested stock are also granted to non-employee directors, with service conditions. For nonvested stock awarded in 2009 and 2008, nonvested shares participate in cash dividends during the restricted period. For nonvested stock awarded in 2011 and 2010, dividend equivalents, whether in stock or cash form, are not paid until the underlying award vests.

The fair value of nonvested stock awards is measured based on the stock price at the grant date, adjusted for non-participating dividends, as applicable, based on the current dividend rate. For nonvested stock awards to employees in 2011, 2010, 2009, and 2008, under the Company's Performance/Restricted Stock Program (PRSP), one-half of the nonvested stock ("performance shares") vests only on the attainment of an income target, measured over a cumulative three-year period. The remaining nonvested stock awarded to employees vests over a service period of five years, with accelerated vesting to three years if the performance shares' vesting criterion is attained. Expense for each of these awards is recognized based on estimates of attaining the performance criterion, including estimated forfeitures. As of December 31, 2011, the income statement metrics for the 2011 and 2010 awards were expected to be attained for the performance shares, and expense for both portions of the awards was recognized on a straight line basis based on a three-year vesting assumption. The income statement metric for the 2009 PRSP nonvested stock award comprising 547,870 shares was met as of December 31, 2011. At December 31, 2010, the three year performance metric for the 2008 PRSP nonvested stock award was not met, and 66,483 shares were forfeited. Expense for the remaining portion of 2008 PRSP award is being recognized over the five year service vesting period through February 2013.

In 2011, the Company made nonvested stock awards to certain executives under the Performance Equity Payment Program (PEPP). These stock awards have single year vesting if an income target is attained, and dividends on these nonvested shares are escrowed and paid in cash when and if the shares vest. Based on the Company's attainment of predetermined levels of earnings, 56,287 PEPP nonvested stock awards vested in 2011. On December 8, 2011, the Company announced the termination of the PEPP effective December 31, 2011, and no further awards will be made under this program.

Compensation expense related to all nonvested stock awards was \$21.0 million in 2011, \$12.9 million in 2010, and \$6.2 million in 2009. In 2011, the retirements of certain senior executives resulted in the accelerated recognition of \$3.4 million of nonvested stock compensation expense. The underlying shares for awards to employees who meet the retirement criteria retain their restrictions until the performance or service vesting conditions for the award periods are determined. Approximately \$13.7 million of unrecognized fair value compensation expense relating to nonvested stock awards is expected to be recognized through 2013 based on estimates of attaining performance vesting criteria, including estimated forfeitures. Activity under the Company's nonvested stock awards for the years ended December 31, 2011, 2010 and 2009 were as follows:

<i>(Shares in thousands, \$ in millions)</i>	2011		2010		2009	
	Number of shares	Weighted Average Grant Date Fair Value	Number of shares	Weighted Average Grant Date Fair Value	Number of shares	Weighted Average Grant Date Fair Value
Nonvested, beginning of year	976	\$ 33.3	740	\$ 26.9	281	\$ 25.7
Granted	319	19.5	400	17.0	590	13.7
Vested	(616)	(16.3)	(78)	(4.3)	(105)	(10.7)
Forfeited	(2)	(0.1)	(86)	(6.3)	(26)	(1.8)
Nonvested, end of year	677	\$ 36.4	976	\$ 33.3	740	\$ 26.9

**Total shareholder return incentive compensation program ("TSRP") awards:** Awards under the TSRP are granted at a target number of shares, and vest based on the measured return of the Company's stock price and dividend performance at the end of three-year periods as compared to the stock price and dividend performance of a group of industry peers. In 2011, the Company established a 2011-2013 TSRP, with 211,029 shares as the target award level. The actual number of shares awarded may range from a minimum of zero to a maximum of three times target. Fair values for the TSRP awards were estimated using Monte Carlo simulations of stock price correlation, projected dividend yields and other variables over three-year time horizons matching the TSRP performance periods. Compensation expense was \$26.5 million in 2011, \$14.9 million in 2010, and \$14.5 million in 2009 for the fair value of TSRP awards. The above amount includes recognition of \$5.0 million expense in 2011 that, due to continuing consulting arrangements with the Company, three former senior executives may become entitled to all TSRP shares awarded to them for the 2009-2001 and 2010-2012 TSRP awards.

The estimated fair value of each TSRP award, the projected shares to be awarded and future compensation expense to be recognized for TSRP awards, including estimated forfeitures, was as follows:

*(Shares in thousands, \$ in millions)*

TSRP Award Performance Period	TSRP Award Fair Value	December 31, 2011 Unrecognized Compensation Expense	Minimum Shares	Target Shares	Maximum Shares
2009 - 2011	\$ 20.5	-	-	400	1,200
2010 - 2012	\$ 26.1	10.4	-	228	685
2011 - 2013	\$ 20.5	14.1	-	161	482
<b>Total</b>		<b>\$ 24.5</b>	<b>-</b>	<b>789</b>	<b>2,367</b>

An award was earned for the 2009-2011 TSRP performance period based on the Company's stock price and dividend performance for the three-year period ended December 31, 2011 relative to the peer group, which resulted in the issuance of 828,970 shares of stock to participants in the 2012 first quarter.

### ***Undistributed Earnings of Investees***

Stockholders' equity includes undistributed earnings of investees accounted for under the equity method of accounting of approximately \$31 million at December 31, 2011.

### **Note 13. Income Taxes**

The income tax provision (benefit) was as follows:

<i>(in millions)</i>	2011	2010	2009
Current:			
Federal	\$ 44.8	\$ (47.3)	\$ (91.3)
State	8.1	(4.4)	(2.8)
Foreign	13.3	8.9	(1.8)
Total	66.2	(42.8)	(95.9)
Deferred:			
Federal	48.4	83.4	115.5
State	2.4	6.0	3.8
Foreign	(0.7)	0.4	3.5
Total	50.1	89.8	122.8
Income tax provision	\$ 116.3	\$ 47.0	\$ 26.9



The following is a reconciliation of income taxes computed at the statutory U.S. Federal income tax rate to the actual effective income tax provision:

<i>(in millions)</i>	<b>Income Tax Provision</b>		
	<b>2011</b>	2010	2009
Taxes computed at the federal rate	\$ 118.8	\$ 44.0	\$ 22.7
State and local income taxes, net of federal tax benefit	7.7	5.5	(0.6)
Foreign earnings taxed at different rate	(7.6)	(4.8)	(0.4)
Manufacturing deduction	(3.3)	-	-
Tax reserve adjustments	(1.7)	(6.2)	1.6
Adjustment to prior years' taxes	(0.7)	(1.9)	(3.0)
Tax law changes	-	5.8	-
Valuation allowance	1.2	1.6	5.7
Other	1.9	3.0	0.9
<b>Income tax provision</b>	<b>\$ 116.3</b>	<b>\$ 47.0</b>	<b>\$ 26.9</b>

In 2010, tax law changes included \$5.3 million associated with the Patient Protection and Affordable Care Act. Under this legislation, the tax advantage of the subsidy to encourage companies to provide retiree prescription drug coverage was eliminated. Although the elimination of this tax advantage under the new legislation does not take effect until 2013, the Company was required by U.S. generally accepted accounting principles to recognize the full accounting impact in the period in which the Act became law. Since future anticipated retiree health care liabilities and related tax subsidies were already reflected in ATI's financial statements, the change in law resulted in a reduction of the value of the Company's deferred tax asset related to the subsidy. Tax law changes due to the Small Business Jobs and Credit Act, which allows businesses of all sizes to accelerate depreciation on certain property placed into service in 2010, resulted in a taxable loss for U.S. Federal purposes in 2010, which increased the Company's ability to recover prior years' cash taxes paid, but eliminated the current year tax benefit of the manufacturing deduction.

In general, the Company is responsible for filing consolidated U.S. Federal, foreign and combined, unitary or separate state income tax returns. The Company is responsible for paying the taxes relating to such returns, including any subsequent adjustments resulting from the redetermination of such tax liability by the applicable taxing authorities. No provision has been made for U.S. Federal, state or additional foreign taxes related to approximately \$220 million of undistributed earnings of foreign subsidiaries which have been permanently re-invested. It is not practical to determine the deferred tax liability on these earnings.

Income before income taxes for the Company's U.S. and non-U.S. operations was as follows:

<i>(in millions)</i>	<b>2011</b>	2010	2009
U.S.	\$ 280.5	\$ 87.1	\$ 57.9
Non-U.S.	58.9	38.6	7.0
<b>Income before income taxes</b>	<b>\$ 339.4</b>	<b>\$ 125.7</b>	<b>\$ 64.9</b>

Income taxes paid and amounts received as refunds were as follows:

<i>(in millions)</i>	<b>2011</b>	2010	2009
Income taxes paid	\$ 49.2	\$ 28.8	\$ 45.0
Income tax refunds received	(41.0)	(20.9)	(124.3)
<b>Income taxes paid (received), net</b>	<b>\$ 8.2</b>	<b>\$ 7.9</b>	<b>\$ (79.3)</b>

Income taxes paid (received), net has benefited over the last several years from provisions under the U.S. tax code allowing companies to immediately deduct a significant portion of the cost of new capital investments placed into service.

Deferred income taxes result from temporary differences in the recognition of income and expense for financial and income tax reporting purposes, and differences between the fair value of assets acquired in business combinations accounted for as purchases for financial reporting purposes and their corresponding tax bases. Deferred income taxes represent future tax benefits or costs to be recognized when those temporary differences reverse. The categories of assets and liabilities that have resulted in differences in the timing of the recognition of income and expense at December 31, 2011 and 2010 were as follows:

<i>(in millions)</i>	2011	2010
Deferred income tax assets		
Pensions	\$ 185.2	\$ 5.6
Postretirement benefits other than pensions	184.5	177.2
State net operating loss tax carryovers	33.3	30.2
Federal and state tax credits	31.3	30.1
Deferred compensation and other benefit plans	33.7	22.1
Self insurance reserves	10.2	10.1
Other items	78.4	64.9
Gross deferred income tax assets	556.6	340.2
Valuation allowance for deferred tax assets	(22.6)	(21.4)
Total deferred income tax assets	534.0	318.8
Deferred income tax liabilities		
Bases of property, plant and equipment	398.7	305.8
Inventory valuation	83.6	57.4
Bases of amortizable intangible assets	70.4	10.3
Other items	14.6	19.5
Total deferred tax liabilities	567.3	393.0
Net deferred tax (liability) asset	\$ (33.3)	\$ (74.2)

The Company had \$22.6 million and \$21.4 million in deferred tax asset valuation allowances at December 31, 2011 and 2010, respectively, related to state deferred tax assets. The valuation allowance at December 31, 2011 includes \$10.2 million for state net operating loss tax carryforwards, \$7.7 million for state tax credits and \$4.7 million for state temporary differences, since the Company has concluded, based on current state tax laws, that it is more likely than not that these tax benefits would not be realized. For these state net operating loss tax carryforwards, expiration will generally occur in 20 years and utilization of the tax benefit is limited to \$3 million per year or 20% of apportioned income, which ever is greater.

The changes in the liability for unrecognized income tax benefits for the years ended December 31, 2011, 2010 and 2009 were as follows:

<i>(in millions)</i>	2011	2010	2009
Balance at beginning of year	\$ 17.1	\$ 37.3	\$ 34.7
Increases in prior period tax positions	1.3	1.5	1.2
Decreases in prior period tax positions	(1.3)	(15.8)	-
Increases in current period tax positions	0.1	0.3	0.7
Decreases in current period tax positions	-	-	(0.8)
Uncertain tax positions assumed in Ladish acquisition	14.5	-	-
Expiration of the statute of limitations	(1.8)	-	-
Settlements	(0.7)	(1.1)	-
Interest and penalties, net	0.5	(5.1)	1.5
Balance at end of year	\$ 29.7	\$ 17.1	\$ 37.3

In connection with the May 9, 2011 Ladish acquisition, the Company assumed \$14.5 million of uncertain income tax position liabilities, including \$2.5 million in interest and penalties. At December 31, 2011, interest and penalties included in the liability for unrecognized tax benefits were \$5.7 million.

For the year ended December 31, 2010, as a result of the settlements of uncertain income tax positions, the liability for unrecognized income tax benefits was reduced by \$18.5 million, including \$5.7 million of interest and penalties. The settlements increased deferred tax liabilities by \$12.8 million, and the interest and penalty component reduced the current year's income tax provision. Additionally, the Company's income tax provision included charges related to uncertain tax positions in the amount of \$1.8 million, and interest and penalties of \$0.6 million.

Including tax positions for which the Company determined that the tax position would not meet the more-likely-than-not recognition threshold upon examination by the tax authorities based upon the technical merits of the position, the total estimated

unrecognized tax benefit that, if recognized, would affect our effective tax rate was approximately \$23 million. At this time, the Company believes that it is reasonably possible that approximately \$3 million of the estimated unrecognized tax benefits as of December 31, 2011 will be recognized within the next twelve months based on the expiration of statutory review periods.

The Company, and/or one of its subsidiaries, files income tax returns in the U.S. Federal jurisdiction and in various state and foreign jurisdictions. A summary of tax years that remain subject to examination, by major tax jurisdiction, is as follows:

<i>Jurisdiction</i>	Earliest Year Open to Examination
U.S. Federal	2009
States:	
Alabama	2008
Illinois	2008
North Carolina	2007
Oregon	2008
Pennsylvania	2008
Foreign:	
China	2007
Germany	2006
United Kingdom	2009

#### **Note 14. Business Segments**

The Company operates in three business segments: High Performance Metals, Flat-Rolled Products and Engineered Products. The High Performance Metals segment produces, converts and distributes a wide range of high performance alloys, including titanium and titanium-based alloys, nickel- and cobalt-based alloys and superalloys, exotic alloys such as zirconium, hafnium, niobium, nickel-titanium, and their related alloys, advanced powder alloys, and other specialty metals, in long product forms such as ingot, billet, bar, shapes and rectangles, rod, wire, and seamless tubes, plus precision forgings and castings, and machined parts. The companies in this segment include ATI Allvac, ATI Allvac Ltd (U.K.), ATI Wah Chang, ATI Ladish, and ATI Powder Metals.

The Flat-Rolled Products segment produces, converts and distributes stainless steel, nickel-based alloys, specialty alloys, and titanium and titanium-based alloys in a variety of product forms, including plate, sheet, engineered strip and Precision Rolled Strip® products as well as grain-oriented electrical steel sheet. The companies in this segment include ATI Allegheny Ludlum, STAL, in which the Company has a 60% ownership interest, and ATI's 50% interest in Uniti, which is accounted for under the equity method. Sales to Uniti, which are included in ATI's consolidated statements of income, were \$149.1 million in 2011, \$98.3 million in 2010, and \$80.5 million in 2009. ATI's share of Uniti's income (loss) was \$7.4 million in 2011, \$2.5 million in 2010, and \$(2.7) million in 2009, which is included in the Flat-Rolled Products segment's operating profit, and within cost of sales in the consolidated statements of income. The remaining 50% interest in Uniti is held by VSMPO, a Russian producer of titanium, aluminum, and specialty steel products.

The Engineered Products segment's principal business produces tungsten powder, tungsten heavy alloys, tungsten carbide materials and carbide cutting tools. This segment also produces carbon alloy steel impression die forgings and large grey and ductile iron castings, and performs precision metals processing services. The companies in this segment are ATI Tungsten Materials, ATI Portland Forge, ATI Casting Service and ATI Precision Finishing.

Intersegment sales are generally recorded at full cost or market. Common services are allocated on the basis of estimated utilization.

<i>(in millions)</i>	2011	2010	2009
Total sales:			
High Performance Metals	\$ 2,061.0	\$ 1,410.5	\$ 1,357.4
Flat-Rolled Products	2,759.0	2,360.2	1,564.9
Engineered Products	545.4	411.7	268.8
Total sales	5,365.4	4,182.4	3,191.1
Intersegment sales:			
High Performance Metals	105.1	73.0	57.4
Flat-Rolled Products	33.0	21.7	48.8
Engineered Products	44.3	39.9	30.0
Total intersegment sales	182.4	134.6	136.2
Sales to external customers:			
High Performance Metals	1,955.9	1,337.5	1,300.0
Flat-Rolled Products	2,726.0	2,338.5	1,516.1
Engineered Products	501.1	371.8	238.8
Total sales to external customers	\$ 5,183.0	\$ 4,047.8	\$ 3,054.9

Total direct international sales were \$1,814.1 million in 2011, \$1,283.8 million in 2010, and \$950.4 million in 2009. Of these amounts, sales by operations in the United States to customers in other countries were \$1,356.3 million in 2011, \$950.4 million in 2010, and \$678.6 million in 2009.

<i>(in millions)</i>	2011	2010	2009
Operating profit (loss):			
High Performance Metals	\$ 364.5	\$ 257.8	\$ 234.7
Flat-Rolled Products	213.4	85.9	71.3
Engineered Products	34.1	12.8	(23.8)
Total operating profit	612.0	356.5	282.2
Corporate expenses	(92.5)	(64.1)	(53.1)
Interest expense, net	(92.3)	(62.7)	(19.3)
Other expenses, net of gains on asset sales	(9.9)	(13.9)	(13.8)
Debt extinguishment costs	-	-	(9.2)
Retirement benefit expense	(77.9)	(90.1)	(121.9)
Income before income taxes	\$ 339.4	\$ 125.7	\$ 64.9

Business segment operating profit excludes costs for restructuring charges, retirement benefit income or expense, corporate expenses, interest expenses, debt extinguishment costs, and costs associated with closed operations. These costs are excluded for segment reporting to provide a profit measure based on what management considers to be controllable costs at the segment level. Retirement benefit expense includes both pension expense and other postretirement benefit expenses. In April 2008, the Company entered into a new five-year labor agreement with United Steelworkers represented employees at the Wah Chang operation and agreed to establish a Voluntary Employee Benefit Association (VEBA) trust for certain postretirement benefits. The Company recognized \$0.2 million and \$2.2 million of expense for the years ended December 31, 2010 and 2009, respectively, for this VEBA, which is included in retirement benefit expense as reported above in business segments.

Other expenses, net of gains on asset sales, includes charges incurred in connection with closed operations, pre-tax gains and losses on the sale of surplus real estate, non-strategic investments, and other assets, and other non-operating income or expense, which are primarily included in selling and administrative expenses, and in other income (expense) in the consolidated statement of income. In 2011, the Company recorded \$9.9 million in other charges primarily related to closed companies, including \$4.9 million for environmental costs and \$5.0 million for other expenses including legal matters and foreign exchange losses. In 2010, the Company recorded \$13.9 million in other charges primarily related to closed companies, including \$2.1 million for environmental costs, \$2.8 million for real estate costs at closed companies, and \$9.0 million for other expenses including legal matters and foreign exchange losses. In 2009, the Company recorded \$13.8 million in other charges primarily related to closed companies, including \$2.8 million for environmental costs, \$3.7 million for real estate costs at closed companies, and \$7.3 million for other expenses including legal matters.

Certain additional information regarding the Company's business segments is presented below:

<i>(in millions)</i>	2011	2010	2009
Depreciation and amortization:			
High Performance Metals	\$ 110.4	\$ 77.7	\$ 65.3
Flat-Rolled Products	48.3	48.1	47.6
Engineered Products	14.5	14.3	16.1
Corporate	1.2	1.4	3.6
Total depreciation and amortization	174.4	141.5	132.6
Capital expenditures:			
High Performance Metals	83.5	113.7	298.0
Flat-Rolled Products	175.0	95.8	104.8
Engineered Products	16.0	9.1	9.6
Corporate	3.7	0.5	3.0
Total capital expenditures	278.2	219.1	415.4
Identifiable assets:			
High Performance Metals	3,659.8	2,283.4	2,106.3
Flat-Rolled Products	1,577.6	1,362.0	1,117.0
Engineered Products	315.2	295.5	259.0
Corporate:			
Prepaid pension cost	-	8.7	-
Deferred taxes	-	-	63.1
Cash and cash equivalents and other	494.3	544.0	800.6
Total assets	\$ 6,046.9	\$ 4,493.6	\$ 4,346.0

Geographic information for external sales based on country of origin, and assets, are as follows:

<i>(\$ in millions)</i>	2011	Percent of total	2010	Percent of total	2009	Percent of total
External sales:						
United States	\$ 3,368.9	65%	\$ 2,764.0	68%	\$ 2,104.4	69%
China	265.5	5%	234.5	6%	185.2	6%
Germany	258.5	5%	183.7	5%	123.2	4%
United Kingdom	257.3	5%	118.1	3%	118.5	4%
France	180.2	3%	94.3	2%	91.9	3%
Japan	169.8	3%	28.2	1%	33.1	1%
Italy	142.6	3%	175.7	4%	53.8	2%
Canada	131.8	3%	109.0	3%	114.2	4%
Mexico	64.5	1%	56.6	1%	17.6	1%
Other	343.9	7%	283.7	7%	213.0	6%
Total External Sales	\$ 5,183.0	100%	\$ 4,047.8	100%	\$ 3,054.9	100%

<i>(\$ in millions)</i>	2011	Percent of total	2010	Percent of total	2009	Percent of total
Total assets:						
United States	\$ 5,271.7	87%	\$ 3,853.9	86%	\$ 3,759.4	87%
China	266.6	5%	250.4	6%	224.0	5%
United Kingdom	233.0	4%	200.4	4%	175.4	4%
Luxembourg (a)	86.3	1%	97.3	2%	105.1	2%
Other	189.3	3%	91.6	2%	82.1	2%
Total Assets	\$ 6,046.9	100%	\$ 4,493.6	100%	\$ 4,346.0	100%

(a) Comprises assets held by the Company's European Treasury Center operation.



## Note 15. Per Share Information

The following table sets forth the computation of basic and diluted net income per common share:

*(in millions, except per share amounts)*

Years ended December 31,	2011	2010	2009
Numerator:			
Numerator for basic net income per common share -			
Net income attributable to ATI	\$ 214.3	\$ 70.7	\$ 31.7
Effect of dilutive securities:			
4.25% Convertible Notes due 2014	9.9	-	-
Numerator for diluted net income per common share -			
Net income attributable to ATI after assumed conversions	\$ 224.2	\$ 70.7	\$ 31.7
Denominator:			
Denominator for basic net income per common share - weighted average shares	102.5	97.4	97.2
Effect of dilutive securities:			
Share-based compensation	1.8	1.3	0.9
4.25% Convertible Notes due 2014	9.6	-	-
Denominator for diluted net income per common share - adjusted weighted average shares and assumed conversions	113.9	98.7	98.1
Basic net income attributable to ATI per common share	\$ 2.09	\$ 0.73	\$ 0.33
Diluted net income attributable to ATI per common share	\$ 1.97	\$ 0.72	\$ 0.32

Common stock that would be issuable upon the assumed conversion of the 2014 Convertible Notes and other option equivalents and contingently issuable shares were excluded from the computation of contingently issuable shares, and therefore, from the denominator for diluted earnings per share, if the effect of inclusion would have been anti-dilutive. Excluded shares for 2010 and 2009 were 9.6 million and 5.7 million, respectively.

The Company issued 7.3 million shares of common stock as part of the Ladish acquisition consideration completed on May 9, 2011. Weighted average shares for 2011 included 4.7 million shares as a result of the acquisition.

## Note 16. Financial Information for Subsidiary and Guarantor Parent

The payment obligations under the \$150 million 6.95% debentures due 2025 issued by Allegheny Ludlum Corporation (the "Subsidiary") are fully and unconditionally guaranteed by Allegheny Technologies Incorporated (the "Guarantor Parent"). In accordance with positions established by the Securities and Exchange Commission, the following financial information sets forth separately financial information with respect to the Subsidiary, the non-guarantor subsidiaries and the Guarantor Parent. The principal elimination entries eliminate investments in subsidiaries and certain intercompany balances and transactions. Investments in subsidiaries, which are eliminated in consolidation, are included in other assets on the balance sheets.

Allegheny Technologies is the plan sponsor for the U.S. qualified defined benefit pension plan (the "Plan") which covers certain current and former employees of the Subsidiary and the non-guarantor subsidiaries. As a result, the balance sheets presented for the Subsidiary and the non-guarantor subsidiaries do not include any Plan assets or liabilities, or the related deferred taxes. The Plan assets, liabilities and related deferred taxes and pension income or expense are recognized by the Guarantor Parent. Management and royalty fees charged to the Subsidiary and to the non-guarantor subsidiaries by the Guarantor Parent have been excluded solely for purposes of this presentation.

Cash flows related to intercompany activity between the Guarantor Parent, the Subsidiary, and the non-guarantor subsidiaries are presented as financing activities on the condensed statements of cash flows.

Allegheny Technologies Incorporated  
Financial Information for Subsidiary and Guarantor Parent  
Balance Sheets  
December 31, 2011

<i>(In millions)</i>	Guarantor		Non-guarantor		Consolidated
	Parent	Subsidiary	Subsidiaries	Eliminations	
<b>Assets:</b>					
Cash and cash equivalents	\$ 0.8	\$ 129.7	\$ 250.1	\$ -	\$ 380.6
Accounts receivable, net	0.1	220.6	488.4	-	709.1
Inventories, net	-	299.0	1,085.3	-	1,384.3
Prepaid expenses and other current assets	10.5	20.0	65.0	-	95.5
<b>Total current assets</b>	<b>11.4</b>	<b>669.3</b>	<b>1,888.8</b>	<b>-</b>	<b>2,569.5</b>
Property, plant and equipment, net	3.0	614.9	1,750.9	-	2,368.8
Cost in excess of net assets acquired	-	112.1	625.6	-	737.7
Investments in subsidiaries and other assets	5,287.3	1,579.0	996.6	(7,492.0)	370.9
<b>Total assets</b>	<b>\$ 5,301.7</b>	<b>\$ 2,975.3</b>	<b>\$ 5,261.9</b>	<b>\$ (7,492.0)</b>	<b>\$ 6,046.9</b>
<b>Liabilities and stockholders' equity:</b>					
Accounts payable	\$ 4.1	\$ 222.5	\$ 264.1	\$ -	\$ 490.7
Accrued liabilities	961.8	66.7	736.2	(1,444.4)	320.3
Deferred income taxes	23.5	-	-	-	23.5
Short-term debt and current portion of long-term debt	-	0.1	27.2	-	27.3
<b>Total current liabilities</b>	<b>989.4</b>	<b>289.3</b>	<b>1,027.5</b>	<b>(1,444.4)</b>	<b>861.8</b>
Long-term debt	1,252.5	350.7	78.8	(200.0)	1,482.0
Accrued postretirement benefits	-	215.5	272.6	-	488.1
Pension liabilities	441.6	5.7	61.6	-	508.9
Deferred income taxes	9.8	-	-	-	9.8
Other long-term liabilities	36.8	17.2	70.7	-	124.7
<b>Total liabilities</b>	<b>2,730.1</b>	<b>878.4</b>	<b>1,511.2</b>	<b>(1,644.4)</b>	<b>3,475.3</b>
<b>Total stockholders' equity</b>	<b>2,571.6</b>	<b>2,096.9</b>	<b>3,750.7</b>	<b>(5,847.6)</b>	<b>2,571.6</b>
<b>Total liabilities and stockholders' equity</b>	<b>\$ 5,301.7</b>	<b>\$ 2,975.3</b>	<b>\$ 5,261.9</b>	<b>\$ (7,492.0)</b>	<b>\$ 6,046.9</b>

Allegheny Technologies Incorporated  
Financial Information for Subsidiary and Guarantor Parent  
Statements of Operations  
For the year ended December 31, 2011

<i>(In millions)</i>	Guarantor		Non-guarantor		Eliminations	Consolidated
	Parent	Subsidiary	Subsidiaries			
Sales	\$ -	\$ 2,363.4	\$ 2,819.6	\$ -	\$ -	\$ 5,183.0
Cost of sales	27.4	2,129.2	2,213.2	-	-	4,369.8
Selling and administrative expenses	168.6	50.9	162.6	-	-	382.1
Income (loss) before interest, other income and income taxes	(196.0)	183.3	443.8	-	-	431.1
Interest expense, net	(81.6)	(10.4)	(0.3)	-	-	(92.3)
Other income (expense) including equity in income of unconsolidated subsidiaries	617.0	4.1	2.6	(623.1)	-	0.6
Income before income tax provision	339.4	177.0	446.1	(623.1)	-	339.4
Income tax provision	116.3	68.8	155.1	(223.9)	-	116.3
Net income	223.1	108.2	291.0	(399.2)	-	223.1
Less: Net income attributable to noncontrolling interest	8.8	-	8.8	(8.8)	-	8.8
Net income attributable to ATI	\$ 214.3	\$ 108.2	\$ 282.2	\$ (390.4)	\$ -	\$ 214.3

Condensed Statements of Cash Flows  
For the year ended December 31, 2011

<i>(In millions)</i>	Guarantor		Non-guarantor		Eliminations	Consolidated
	Parent	Subsidiary	Subsidiaries			
Cash flows provided by (used in) operating activities	\$ (16.2)	\$ 78.2	\$ 234.8	\$ -	\$ -	\$ 296.8
Cash flows used in investing activities	(385.1)	(160.8)	(74.3)	(4.5)	-	(624.7)
Cash flows provided by (used in) financing activities	400.2	53.2	(181.7)	4.5	-	276.2
Increase (decrease) in cash and cash equivalents	\$ (1.1)	\$ (29.4)	\$ (21.2)	\$ -	\$ -	\$ (51.7)

Allegheny Technologies Incorporated  
Financial Information for Subsidiary and Guarantor Parent  
Balance Sheets  
December 31, 2010

<i>(In millions)</i>	Guarantor		Non-guarantor		Consolidated
	Parent	Subsidiary	Subsidiaries	Eliminations	
<b>Assets:</b>					
Cash and cash equivalents	\$ 1.9	\$ 159.1	\$ 271.3	\$ -	\$ 432.3
Accounts receivable, net	0.1	233.3	312.0	-	545.4
Inventories, net	-	232.6	791.9	-	1,024.5
Prepaid expenses and other current assets	48.6	19.2	45.1	-	112.9
<b>Total current assets</b>	<b>50.6</b>	<b>644.2</b>	<b>1,420.3</b>	<b>-</b>	<b>2,115.1</b>
Property, plant and equipment, net	2.8	483.5	1,503.0	-	1,989.3
Cost in excess of net assets acquired	-	112.2	94.6	-	206.8
Investments in subsidiaries and other assets	4,249.2	1,554.2	1,001.0	(6,622.0)	182.4
<b>Total assets</b>	<b>\$ 4,302.6</b>	<b>\$ 2,794.1</b>	<b>\$ 4,018.9</b>	<b>\$ (6,622.0)</b>	<b>\$ 4,493.6</b>
<b>Liabilities and stockholders' equity:</b>					
Accounts payable	\$ 5.5	\$ 173.3	\$ 215.3	\$ -	\$ 394.1
Accrued liabilities	1,179.3	62.9	704.8	(1,697.1)	249.9
Deferred income taxes	5.6	-	-	-	5.6
Short-term debt and current portion of long-term debt	117.3	10.4	13.7	-	141.4
<b>Total current liabilities</b>	<b>1,307.7</b>	<b>246.6</b>	<b>933.8</b>	<b>(1,697.1)</b>	<b>791.0</b>
Long-term debt	752.5	350.8	18.6	(200.0)	921.9
Accrued postretirement benefits	-	236.6	187.2	-	423.8
Pension liabilities	12.9	6.2	39.2	-	58.3
Deferred income taxes	68.6	-	-	-	68.6
Other long-term liabilities	31.5	20.0	49.1	-	100.6
<b>Total liabilities</b>	<b>2,173.2</b>	<b>860.2</b>	<b>1,227.9</b>	<b>(1,897.1)</b>	<b>2,364.2</b>
<b>Total stockholders' equity</b>	<b>2,129.4</b>	<b>1,933.9</b>	<b>2,791.0</b>	<b>(4,724.9)</b>	<b>2,129.4</b>
<b>Total liabilities and stockholders' equity</b>	<b>\$ 4,302.6</b>	<b>\$ 2,794.1</b>	<b>\$ 4,018.9</b>	<b>\$ (6,622.0)</b>	<b>\$ 4,493.6</b>

Allegheny Technologies Incorporated  
Financial Information for Subsidiary and Guarantor Parent  
Statements of Operations  
For the year ended December 31, 2010

<i>(In millions)</i>	Guarantor		Non-guarantor		Eliminations	Consolidated
	Parent	Subsidiary	Subsidiaries			
Sales	\$ -	\$ 2,056.5	\$ 1,991.3	\$ -	\$ -	\$ 4,047.8
Cost of sales	44.0	1,968.4	1,545.1	-	-	3,557.5
Selling and administrative expenses	126.2	28.8	149.9	-	-	304.9
Income (loss) before interest, other income and income taxes	(170.2)	59.3	296.3	-	-	185.4
Interest income (expense), net	(52.2)	(10.2)	(0.3)	-	-	(62.7)
Other income (expense) including equity in income of unconsolidated subsidiaries	348.1	8.5	3.8	(357.4)	-	3.0
Income before income tax provision	125.7	57.6	299.8	(357.4)	-	125.7
Income tax provision	47.0	20.0	124.0	(144.0)	-	47.0
Net income	78.7	37.6	175.8	(213.4)	-	78.7
Less: Net income attributable to noncontrolling interest	8.0	-	8.0	(8.0)	-	8.0
Net income attributable to ATI	\$ 70.7	\$ 37.6	\$ 167.8	\$ (205.4)	\$ -	\$ 70.7

Condensed Statements of Cash Flows  
For the year ended December 31, 2010

<i>(In millions)</i>	Guarantor		Non-guarantor		Eliminations	Consolidated
	Parent	Subsidiary	Subsidiaries			
Cash flows provided by (used in) operating activities	\$ (23.8)	\$ (188.9)	\$ 271.2	\$ (31.4)	\$ -	\$ 27.1
Cash flows used in investing activities	(0.2)	(68.7)	(123.0)	(24.9)	-	(216.8)
Cash flows provided by (used in) financing activities	18.7	(55.5)	(106.3)	56.3	-	(86.8)
Increase (decrease) in cash and cash equivalents	\$ (5.3)	\$ (313.1)	\$ 41.9	\$ -	\$ -	\$ (276.5)



Allegheny Technologies Incorporated  
Financial Information for Subsidiary and Guarantor Parent  
Statements of Operations  
For the year ended December 31, 2009

<i>(In millions)</i>	Guarantor		Non-guarantor		Consolidated
	Parent	Subsidiary	Subsidiaries	Eliminations	
Sales	\$ -	\$ 1,380.3	\$ 1,674.6	\$ -	\$ 3,054.9
Cost of sales	68.5	1,284.2	1,293.8	-	2,646.5
Selling and administrative expenses	127.7	36.5	151.5	-	315.7
Income (loss) before interest, other income and income taxes	(196.2)	59.6	229.3	-	92.7
Interest income (expense), net	(9.5)	(9.8)	-	-	(19.3)
Debt extinguishment costs	(9.2)	-	-	-	(9.2)
Other income (expense) including equity in income of unconsolidated subsidiaries	279.8	2.6	5.7	(287.4)	0.7
Income before income tax provision	64.9	52.4	235.0	(287.4)	64.9
Income tax provision	26.9	18.8	93.6	(112.4)	26.9
Net income	38.0	33.6	141.4	(175.0)	38.0
Less: Net income attributable to noncontrolling interest	6.3	-	6.3	(6.3)	6.3
Net income attributable to ATI	\$ 31.7	\$ 33.6	\$ 135.1	\$ (168.7)	\$ 31.7

Condensed Statements of Cash Flows  
For the year ended December 31, 2009

<i>(In millions)</i>	Guarantor		Non-guarantor		Consolidated
	Parent	Subsidiary	Subsidiaries	Eliminations	
Cash flows provided by (used in) operating activities	\$ (46.2)	\$ 62.5	\$ 184.3	\$ 17.9	\$ 218.5
Cash flows used in investing activities	(132.8)	(48.1)	(334.5)	61.7	(453.7)
Cash flows provided by financing activities	182.8	176.0	194.9	(79.6)	474.1
Increase in cash and cash equivalents	\$ 3.8	\$ 190.4	\$ 44.7	\$ —	\$ 238.9

**Note 17. Commitments and Contingencies**

Rental expense under operating leases was \$21.4 million in 2011, \$21.1 million in 2010, and \$21.2 million in 2009. Future minimum rental commitments under operating leases with non-cancelable terms of more than one year at December 31, 2011, were as follows: \$17.0 million in 2012, \$13.3 million in 2013, \$12.2 million in 2014, \$10.5 million in 2015, \$5.1 million in 2016 and \$29.3 million thereafter. Commitments for expenditures on property, plant and equipment at December 31, 2011 were approximately \$529.6 million.

The Company is subject to various domestic and international environmental laws and regulations that govern the discharge of pollutants and disposal of wastes, and which may require that it investigate and remediate the effects of the release or disposal of materials at sites associated with past and present operations. The Company could incur substantial cleanup costs, fines, and civil or criminal sanctions, third party property damage or personal injury claims as a result of violations or liabilities under these laws or noncompliance with environmental permits required at its facilities. The Company is currently involved in the investigation and remediation of a number of its current and former sites, as well as third party sites.

Environmental liabilities are recorded when the Company's liability is probable and the costs are reasonably estimable. In many cases, however, the Company is not able to determine whether it is liable or, if liability is probable, to reasonably estimate the loss or range of loss. Estimates of the Company's liability remain subject to additional uncertainties, including the nature and extent of site contamination, available remediation alternatives, the extent of corrective actions that may be required, and the

number, participation, and financial condition of other potentially responsible parties (“PRPs”). The Company expects that it will adjust its accruals to reflect new information as appropriate. Future adjustments could have a material adverse effect on the Company’s results of operations in a given period, but the Company cannot reliably predict the amounts of such future adjustments.

Based on currently available information, the Company does not believe that there is a reasonable possibility that a loss exceeding the amount already accrued for any of the sites with which the Company is currently associated (either individually or in the aggregate) will be an amount that would be material to a decision to buy or sell the Company’s securities. Future developments, administrative actions or liabilities relating to environmental matters, however, could have a material adverse effect on the Company’s financial condition or results of operations.

At December 31, 2011, the Company’s reserves for environmental remediation obligations totaled approximately \$15 million, of which \$8 million was included in other current liabilities. The reserve includes estimated probable future costs of \$6 million for federal Superfund and comparable state-managed sites; \$6 million for formerly owned or operated sites for which the Company has remediation or indemnification obligations; \$2 million for owned or controlled sites at which Company operations have been discontinued; and \$1 million for sites utilized by the Company in its ongoing operations. The Company continues to evaluate whether it may be able to recover a portion of future costs for environmental liabilities from third parties.

The timing of expenditures depends on a number of factors that vary by site. The Company expects that it will expend present accruals over many years and that remediation of all sites with which it has been identified will be completed within thirty years.

A number of other lawsuits, claims and proceedings have been or may be asserted against the Company relating to the conduct of its currently and formerly owned businesses, including those pertaining to product liability, patent infringement, commercial, government contract work, employment, employee and retiree benefits, taxes, environmental, health and safety, occupational disease, and stockholder matters. While the outcome of litigation cannot be predicted with certainty, and some of these lawsuits, claims or proceedings may be determined adversely to the Company, management does not believe that the disposition of any such pending matters is likely to have a material adverse effect on the Company’s financial condition or liquidity, although the resolution in any reporting period of one or more of these matters could have a material adverse effect on the Company’s results of operations for that period.

**Note 18. Selected Quarterly Financial Data  
(Unaudited)**

<i>(In millions except share and per share amounts)</i>	<b>Quarter Ended</b>			
	<b>March 31</b>	<b>June 30</b>	<b>September 30</b>	<b>December 31</b>
<b>2011 -</b>				
Sales	\$ 1,227.4	\$ 1,351.6	\$ 1,352.6	\$ 1,251.4
Gross Profit	205.4	223.0	215.8	169.0
Net income attributable to ATI	56.3	64.0	62.3	31.7
Basic net income per common share	\$ 0.58	\$ 0.63	\$ 0.59	\$ 0.30
Diluted net income per common share	\$ 0.54	\$ 0.59	\$ 0.56	\$ 0.29
Average shares outstanding	98,767,947	103,405,003	106,341,817	106,358,868
<b>2010 -</b>				
Sales	\$ 899.4	\$ 1,052.0	\$ 1,058.8	\$ 1,037.6
Gross Profit	121.4	151.8	89.8	127.3
Net income attributable to ATI	18.2	36.4	1.0	15.1
Basic net income per common share	\$ 0.19	\$ 0.37	\$ 0.01	\$ 0.16
Diluted net income per common share	\$ 0.18	\$ 0.36	\$ 0.01	\$ 0.15
Average shares outstanding	98,317,319	98,563,774	98,576,117	98,593,745

The first quarter 2011 included a special charge of \$3.1 million, net of tax, related to the accelerated recognition of equity-based compensation expense due to previously announced executive retirements. In addition, first quarter 2011 results included a discrete tax charge of \$2.7 million primarily related to foreign income taxes.

Ladish acquisition-related expenses, net of tax, were \$12.7 million, \$8.3 million and \$1.1 million, for the second, third and fourth quarters of 2011, respectively, and were primarily related to inventory fair value adjustments and transaction costs.

Additionally, the fourth quarter 2011 results were impacted by restructuring charges of \$1.7 million, net of tax.

The first quarter 2010 included a non-recurring tax charge of \$5.3 million associated with the Patient Protection and Affordable Care Act. Under this legislation, the tax advantage of the subsidy to encourage companies to provide retiree prescription drug coverage was eliminated. Although the elimination of this tax advantage under the new legislation does not take effect until 2013, the Company was required by U.S. generally accepted accounting principles to recognize the full accounting impact in the 2010 first quarter, the period in which the Act became law. Since future anticipated retiree health care liabilities and related tax subsidies were already reflected in ATI's financial statements, the change in law resulted in a reduction of the value of the Company's deferred tax asset related to the subsidy. This 2010 first quarter tax charge was partially offset by discrete net tax benefits of \$3.7 million associated with adjustment of taxes accrued in prior years, the settlement of uncertain income tax positions, and other changes.

The third quarter 2010 included a tax charge of \$3.9 million primarily due to the Small Business Jobs and Credit Act, which allows businesses of all sizes to immediately deduct from taxable income 50% of the cost of depreciable property placed into service during 2010.

## **Item 9. Changes in and Disagreements with Accountants on Accounting and Financial Disclosure**

Not applicable.

### **Item 9A. Controls and Procedures**

#### ***Disclosure Controls and Procedures***

Our Chief Executive Officer and Chief Financial Officer have evaluated the Company's disclosure controls and procedures (as defined in Rule 13a-15(e) or Rule 15d-15(e) under the Securities Exchange Act of 1934, as amended) as of December 31, 2011, and they concluded that these controls and procedures are effective.

On May 9, 2011, we completed our acquisition of Ladish. See Note 2, "Acquisition of Business" in the notes to the consolidated financial statements in this Annual Report for a discussion of the acquisition, which was not material to ATI's historical results of operations or financial condition. While management does not expect significant changes to our financial reporting processes and related internal controls as a result of the Ladish acquisition, we are currently in the process of evaluating the internal controls and procedures of Ladish, and it will take time for us to fully complete the integration of Ladish's internal controls over financial reporting. Except with respect to our acquisition of Ladish, there was no change in our internal control over financial reporting identified in connection with the evaluation of the Company's disclosure controls and procedures (as defined in Rule 13a-15(e) or Rule 15d-15(e) under the Securities Exchange Act of 1934, as amended) as of December 31, 2011, conducted by our Chief Executive Officer and Chief Financial Officer, that occurred during the quarter ended December 31, 2011 that has materially affected, or is reasonably likely to materially affect, our internal control over financial reporting.

#### ***Management's Report on Internal Control Over Financial Reporting***

Management is responsible for establishing and maintaining adequate internal control over financial reporting for the Company. Internal control over financial reporting is defined in Rules 13a-15(f) and 15d-15(f) promulgated under the Securities Exchange Act of 1934, as amended, as a process designed by, or under the supervision of, the company's principal executive and principal financial officers and effected by the company's board of directors, management and other personnel, to provide reasonable assurance regarding the reliability of financial reporting and the preparation of financial statements for external purposes in accordance with generally accepted accounting principles and includes those policies and procedures that:

Pertain to the maintenance of records that in reasonable detail accurately and fairly reflect the transactions and dispositions of the assets of the company;

Provide reasonable assurance that transactions are recorded as necessary to permit preparation of financial statements in accordance with generally accepted accounting principles, and that receipts and expenditures of the company are being made only in accordance with authorizations of management and directors of the company; and

Provide reasonable assurance regarding prevention or timely detection of unauthorized acquisition, use or disposition of the company's assets that could have a material effect on the financial statements.

Because of its inherent limitations, internal control over financial reporting may not prevent or detect misstatements. Projections of any evaluation of effectiveness to future periods are subject to the risk that controls may become inadequate because of changes in conditions, or that the degree of compliance with the policies or procedures may deteriorate.

Internal control over financial reporting cannot provide absolute assurance of achieving financial reporting objectives because of its inherent limitations. Internal control over financial reporting is a process that involves human diligence and compliance and is subject to lapses in judgment and breakdowns resulting from human failures. Internal control over financial reporting can also be circumvented by collusion or improper management override. Because of such limitations, there is a risk that material misstatements may not be prevented or detected on a timely basis by internal control over financial reporting. However, these inherent limitations are known features of the financial reporting process. Therefore, it is possible to design into the process safeguards to reduce, though not eliminate, this risk.

The Company's management assessed the effectiveness of the Company's internal control over financial reporting as of December 31, 2011. In making this assessment, the Company's management used the criteria set forth by the Committee of Sponsoring Organizations ("COSO") of the Treadway Commission's Internal Control-Integrated Framework.

Based on our assessment, management has concluded that, as of December 31, 2011, the Company's internal control over financial reporting is effective based on those criteria.

In conducting our evaluation of the effectiveness of our internal control over financial reporting, management excluded the Company's acquisition of Ladish Co., Inc. ("Ladish"), which was completed on May 9, 2011. Ladish represented approximately 21% of our total assets as of December 31, 2011 and approximately 6% of our total revenues for the year then ended. The Company's acquisition of Ladish is discussed more fully in Note 2, "Acquisition of Business," to our consolidated financial statements in our Annual Report for our fiscal year ended December 31, 2011. Under guidelines established by the SEC, companies are allowed to exclude acquisitions from their first assessment of internal control over financial reporting following the date of the acquisition.

The Company's independent registered public accounting firm that audited the financial statements included in this Annual Report issued an attestation report on the Company's internal control over financial reporting.

### ***Management's Certifications***

The certifications of the Company's Chief Executive Officer and Chief Financial Officer required by the Sarbanes-Oxley Act are included as Exhibits 31 and 32 to this Annual Report on Form 10-K. In addition, in 2011 the Company's Chief Executive Officer provided to the New York Stock Exchange the annual CEO certification pursuant to Section 303A regarding the Company's compliance with the New York Stock Exchange's corporate governance listing standards.

## ***Report of Independent Registered Public Accounting Firm***

### **The Board of Directors and Stockholders of Allegheny Technologies Incorporated**

We have audited Allegheny Technologies Incorporated and Subsidiaries' internal control over financial reporting as of December 31, 2011, based on criteria established in Internal Control—Integrated Framework issued by the Committee of Sponsoring Organizations of the Treadway Commission (the COSO criteria). Allegheny Technologies Incorporated and Subsidiaries' management is responsible for maintaining effective internal control over financial reporting, and for its assessment of the effectiveness of internal control over financial reporting included in the accompanying Management's Report on Internal Control Over Financial Reporting. Our responsibility is to express an opinion on the company's internal control over financial reporting based on our audit.

We conducted our audit in accordance with the standards of the Public Company Accounting Oversight Board (United States). Those standards require that we plan and perform the audit to obtain reasonable assurance about whether effective internal control over financial reporting was maintained in all material respects. Our audit included obtaining an understanding of internal control over financial reporting, assessing the risk that a material weakness exists, testing and evaluating the design and operating effectiveness of internal control based on the assessed risk, and performing such other procedures as we considered necessary in the circumstances. We believe that our audit provides a reasonable basis for our opinion.

A company's internal control over financial reporting is a process designed to provide reasonable assurance regarding the reliability of financial reporting and the preparation of financial statements for external purposes in accordance with generally accepted accounting principles. A company's internal control over financial reporting includes those policies and procedures that (1) pertain to the maintenance of records that, in reasonable detail, accurately and fairly reflect the transactions and dispositions of the assets of the company; (2) provide reasonable assurance that transactions are recorded as necessary to permit preparation of financial statements in accordance with generally accepted accounting principles, and that receipts and expenditures of the company are being made only in accordance with authorizations of management and directors of the company; and (3) provide reasonable assurance regarding prevention or timely detection of unauthorized acquisition, use or disposition of the company's assets that could have a material effect on the financial statements.

Because of its inherent limitations, internal control over financial reporting may not prevent or detect misstatements. Also, projections of any evaluation of effectiveness to future periods are subject to the risk that controls may become inadequate because of changes in conditions, or that the degree of compliance with the policies or procedures may deteriorate.

In our opinion, Allegheny Technologies Incorporated and Subsidiaries maintained, in all material respects, effective internal control over financial reporting as of December 31, 2011, based on the COSO criteria.

As indicated in the accompanying Management's Report on Internal Control Over Financial Reporting, management's assessment of and conclusion on the effectiveness of internal control over financial reporting did not include the internal controls of the acquired Ladish Co., Inc. ("Ladish) business, which is included in the 2011 consolidated financial statements of Allegheny Technologies Incorporated and Subsidiaries and constituted approximately 21% of total assets as of December 31, 2011 and approximately 6% of total revenues for the period then ended. Our audit of internal control over financial reporting of Allegheny Technologies Incorporated and Subsidiaries also did not include an evaluation of the internal control over financial reporting of Ladish.

We also have audited, in accordance with the standards of the Public Company Accounting Oversight Board (United States), the consolidated balance sheets of Allegheny Technologies Incorporated and Subsidiaries as of December 31, 2011 and 2010 and the related consolidated statements of income, cash flows, and changes in equity for each of the three years in the period ended December 31, 2011 of Allegheny Technologies Incorporated and Subsidiaries and our report dated February 27, 2012 expressed an unqualified opinion thereon.

/s/ Ernst & Young LLP

Pittsburgh, Pennsylvania  
February 27, 2012



## Item 9B. Other Information

Not applicable.

## PART III

### Item 10. Directors and Executive Officers of the Registrant

In addition to the information set forth under the caption “Executive Management, including Executive Officers under the Federal Securities Laws” in Part I of this report, the information concerning our directors required by this item is incorporated and made part hereof by reference to the material appearing under the heading “Our Corporate Governance” and “Election of Directors” in Allegheny Technologies’ Proxy Statement for the 2012 Annual Meeting of Stockholders (the “2012 Proxy Statement”), which will be filed with the Securities and Exchange Commission, pursuant to Regulation 14A, not later than 120 days after the end of the fiscal year. Information concerning the Audit Committee and its financial expert required by this item is incorporated and made part hereof by reference to the material appearing under the heading “Committees of the Board of Directors – Audit Committee” in the 2012 Proxy Statement. Information required by this item regarding compliance with Section 16(a) of the Exchange Act is incorporated and made a part hereof by reference to the material appearing under the heading “Section 16(a) Beneficial Ownership Reporting Compliance” in the 2012 Proxy Statement. Information concerning the executive officers of Allegheny Technologies is contained in Part I of this Form 10-K under the caption “Executive Management, including Executive Officers under the Federal Securities Laws.”

Allegheny Technologies has adopted Corporate Guidelines for Business Conduct and Ethics that apply to all employees including its principal executive officer, principal financial officer, principal accounting officer or controller, or persons performing similar functions. Allegheny Technologies will provide a copy free of charge. To obtain a copy, contact the Corporate Secretary, Allegheny Technologies Incorporated, 1000 Six PPG Place, Pittsburgh, Pennsylvania 15222-5479 (telephone: 412-394-2800). The *Corporate Guidelines for Business Conduct and Ethics* as well as the charters for the Company’s Audit, Finance, Nominating and Governance, Personnel and Compensation and Technology Committees, as well as periodic and current reports filed with the SEC, are available through the Company’s web site at <http://www.atimetals.com> and are available in print to any shareholder upon request. The Company intends to post on its web site any waiver from or amendment to the guidelines that apply to the officers named that relate to elements of the code of ethics identified by the Securities and Exchange Commission.

### Item 11. Executive Compensation

Information required by this item is incorporated by reference to “Director Compensation,” “Executive Compensation” and “Compensation Committee Interlocks and Insider Participation” as set forth in the 2012 Proxy Statement.

### Item 12. Security Ownership of Certain Beneficial Owners and Management and Related Stockholder Matters

Information relating to the ownership of equity securities by certain beneficial owners and management is incorporated by reference to “Stock Ownership Information” as set forth in the 2012 Proxy Statement.

#### Equity Compensation Plan Information

Information about our equity compensation plans at December 31, 2011 was as follows:

	<u>(a)</u>		
<i>(in thousands, except per share amounts)</i>	Number of Shares to be Issued Upon Exercise of Outstanding Options	Weighted Average Exercise Price of Outstanding Options	Number of Shares Remaining Available for Future Issuance Under Equity Compensation Plans (1) (excluding securities reflected in column (a))
Equity Compensation Plans Approved by Shareholders	427	\$ 7.51	1,002
Equity Compensation Plans Not Approved by Shareholders	-	-	-
<b>Total</b>	<b>427</b>	<b>\$ 7.51</b>	<b>1,002</b>

(1) Represents shares available for issuance under the 2007 Incentive Plan, which was amended and restated in 2010 (which provides for the issuance of stock options and stock appreciation rights, restricted shares, performance and other-stock-based awards). Of the total number of shares authorized under the Incentive Plan, a maximum of 1.35 million shares have been

reserved for issuance for award periods under the Total Shareholder Return Incentive Compensation Program. See Note 12. Stockholders' Equity for a discussion of the Company's stock-based compensation plans.

### **Item 13. Certain Relationships and Related Transactions, and Director Independence**

Information required by this item is incorporated by reference to "Certain Transactions" and "Number and Independence of Directors" as set forth in the 2012 Proxy Statement.

### **Item 14. Principal Accountant Fees and Services**

Information required by this item is incorporated by reference to "Ratification of Selection of Independent Auditors" including "Audit Committee Pre-Approval Policy" and "Independent Auditor: Services and Fees," as set forth in the 2012 Proxy Statement.

## ***PART IV***

### **Item 15. Exhibits, Financial Statements and Financial Statement Schedules**

#### ***(a) Financial Statements, Financial Statement Schedules and Exhibits:***

##### ***(1) Financial Statements***

The following consolidated financial statements and report are filed as part of this report under Item 8 – "Financial Statements and Supplementary Data":

Report of Ernst & Young LLP, Independent Registered Public Accounting Firm

Consolidated Statements of Income — Years Ended December 31, 2011, 2010, and 2009

Consolidated Balance Sheets at December 31, 2011 and 2010

Consolidated Statements of Cash Flows — Years Ended December 31, 2011, 2010, and 2009

Statements of Changes in Consolidated Equity — Years Ended December 31, 2011, 2010, and 2009

Notes to Consolidated Financial Statements

##### ***(2) Financial Statement Schedules***

All schedules set forth in the applicable accounting regulations of the Securities and Exchange Commission either are not required under the related instructions or are not applicable and, therefore, have been omitted.

### (3) Exhibits

Exhibits required to be filed by Item 601 of Regulation S-K are listed below. Documents not designated as being incorporated herein by reference are filed herewith. The paragraph numbers correspond to the exhibit numbers designated in Item 601 of Regulation S-K.

<b>Exhibit No.</b>	<b>Description</b>
2.1	Agreement and Plan of Merger, dated as of November 16, 2010, by and among Allegheny Technologies Incorporated, LPAD Co., PADL LLC and Ladish Co., Inc. (incorporated by reference to Exhibit 2.1 to the Registrant's Current Report on Form 8-K dated November 17, 2010 (File No. 1-12001)).
3.1	Certificate of Incorporation of Allegheny Technologies Incorporated, as amended (incorporated by reference to Exhibit 3.1 to the Registrant's Annual Report on Form 10-K for the year ended December 31, 1999 (File No. 1-12001)).
3.2	Amended and Restated Bylaws of Allegheny Technologies Incorporated (incorporated by reference to Exhibit 3.2 to the Registrant's Annual Report on Form 10-K for the year ended December 31, 1998 (File No. 1-12001)).
4.1	Indenture dated as of December 18, 2001 between Allegheny Technologies Incorporated and The Bank of New York, as trustee, relating to Allegheny Technologies Incorporated's 8.375% Notes due 2011 (incorporated by reference to Exhibit 4.2 to the Registrant's Annual Report on Form 10-K for the year ended December 31, 2001 (File No. 1-12001)).
4.2	Form of 8.375% Notes due 2011 (included as part of Exhibit 4.1).
4.3	Indenture dated as of December 15, 1995 between Allegheny Ludlum Corporation and The Chase Manhattan Bank (National Association), as trustee, relating to Allegheny Ludlum Corporation's 6.95% Debentures due 2025 (incorporated by reference to Exhibit 4(a) to Allegheny Ludlum Corporation's Report on Form 10-K for the year ended December 31, 1995 (File No. 1-9498)), and First Supplemental Indenture by and among Allegheny Technologies Incorporated, Allegheny Ludlum Corporation and The Chase Manhattan Bank (National Association), as Trustee, dated as of August 15, 1996 (incorporated by reference to Exhibit 4.1 to Registrant's Current Report on Form 8-K dated August 15, 1996 (File No. 1-12001)).
4.4	Supplemental Indenture, dated as of December 22, 2011, among Allegheny Ludlum Corporation, ALC Merger, LLC, and The Bank of New York Mellon (as successor to The Chase Manhattan Bank (National Association)), as trustee (filed herewith).
4.5	Indenture, dated June 1, 2009, between Allegheny Technologies Incorporated and The Bank of New York Mellon, as Trustee (incorporated by reference to Exhibit 4.1 to the Registrant's Current Report on Form 8-K dated June 3, 2009 (File No. 1-12001)).
4.6	First Supplemental Indenture, dated June 1, 2009, between Allegheny Technologies Incorporated and The Bank of New York Mellon, as Trustee, relating to Allegheny Technologies Incorporated's 9.375% Senior Notes due 2019 (incorporated by reference to Exhibit 4.2 to the Registrant's Current Report on Form 8-K dated June 3, 2009 (File No. 1-12001)).
4.7	Second Supplemental Indenture, dated June 2, 2009, between Allegheny Technologies Incorporated and The Bank of New York Mellon, as Trustee, relating to Allegheny Technologies Incorporated's 4.25% Convertible Senior Notes due 2014 (incorporated by reference to Exhibit 4.3 to the Registrant's Current Report on Form 8-K dated June 3, 2009 (File No. 1-12001)).
4.8	Form of 9.375% Senior Note due 2019 (incorporated by reference to Exhibit 4.4 to the Registrant's Current Report on Form 8-K dated June 3, 2009 (File No. 1-12001)).
4.9	Form of 4.25% Convertible Senior Note due 2014 (incorporated by reference to Exhibit 4.5 to the Registrant's Current Report on Form 8-K dated June 3, 2009 (File No. 1-12001)).
4.10	Third Supplemental Indenture, dated January 7, 2011, between Allegheny Technologies Incorporated and The Bank of New York Mellon, as Trustee, relating to Allegheny Technologies Incorporated's 5.950% Senior Notes due 2021 (incorporated by reference to Exhibit 4.1 to the Registrant's Current Report on Form 8-K dated January 7, 2011 (File No. 1-12001)).

- 4.11 Form of 5.950% Senior Note due 2021 (incorporated by reference to Exhibit 4.2 to the Registrant's Current Report on Form 8-K dated January 7, 2011 (File No. 1-12001)).
- 4.12 Note Purchase Agreement, dated as of July 20, 2001, by and between Ladish Co., Inc. and the purchasers listed therein (incorporated by reference to Exhibit 10.(E) to the Annual Report on Form 10-K of Ladish Co., Inc. for the year ended December 31, 2001 (File No. 0-23539)).
- 4.13 First Amendment to Note Purchase Agreement, dated as of May 16, 2006, by and between Ladish Co., Inc. and the purchasers listed therein (incorporated by reference to Exhibit 10(b) to the Current Report on Form 8-K filed by Ladish Co., Inc. on May 18, 2006 (File No. 0-23539)).
- 4.14 Series B Terms Agreement to Note Purchase Agreement, dated as of May 16, 2006, by and between Ladish Co., Inc. and the purchasers listed therein (incorporated by reference to Exhibit 10(a) to the Current Report on Form 8-K filed by Ladish Co., Inc. on May 18, 2006 (File No. 0-23539)).
- 4.15 Second Amendment to Note Purchase Agreement, dated as of September 2, 2008, by and between Ladish Co., Inc. and the purchasers listed therein (incorporated by reference to Exhibit 99.C to the Current Report on Form 8-K filed by Ladish Co., Inc. on September 2, 2008 (File No. 0-23539)).
- 4.16 Series C Terms Agreement to Note Purchase Agreement, dated as of September 2, 2008, by and between Ladish Co., Inc. and the purchasers listed therein (incorporated by reference to Exhibit 99.B to the Current Report on Form 8-K filed by Ladish Co., Inc. on September 2, 2008 (File No. 0-23539)).
- 4.17 Third Amendment to Note Purchase Agreement, dated as of December 21, 2009, by and between Ladish Co., Inc. and the purchasers listed therein (incorporated by reference to Exhibit 10(Q) to the Annual Report on Form 10-K of Ladish Co., Inc. for the year ended December 31, 2009 (File No. 0-23539)).
- 10.1 Allegheny Technologies Incorporated 1996 Incentive Plan (incorporated by reference to Exhibit 10.1 to the Registrant's Annual Report on Form 10-K for the year ended December 31, 1997 (File No. 1-12001)).\*
- 10.2 Allegheny Technologies Incorporated 1996 Non-Employee Director Stock Compensation Plan, as amended December 17, 1998 (incorporated by reference to Exhibit 10.4 to the Registrant's Annual Report on Form 10-K for the year ended December 31, 1998 (File No. 1-12001)).\*
- 10.3 Allegheny Technologies Incorporated Fee Continuation Plan for Non-Employee Directors, as amended (incorporated by reference to Exhibit 10.3 to the Registrant's Annual Report on Form 10-K for the year ended December 31, 2004 (File No. 1-12001)).\*
- 10.4 Supplemental Pension Plan for Certain Key Employees of Allegheny Technologies Incorporated and its subsidiaries (formerly known as the Allegheny Ludlum Corporation Key Man Salary Continuation Plan) (incorporated by reference to Exhibit 10.7 to the Company's Annual Report on Form 10-K for the year ended December 31, 1997 (File No. 1-12001)).\*
- 10.5 Allegheny Technologies Incorporated Benefit Restoration Plan, as amended (incorporated by reference to Exhibit 10.8 to the Registrant's Annual Report on Form 10-K for the year ended December 31, 1999 (File No. 1-12001)).\*
- 10.6 Allegheny Technologies Incorporated 2000 Incentive Plan, as amended (incorporated by reference to Exhibit 10.9 to the Registrant's Annual Report on Form 10-K for the year ended December 31, 2005 (File No. 1-12001)).\*
- 10.7 Amendment to the Allegheny Technologies Incorporated Pension Plan effective January 1, 2003 (incorporated by reference to Exhibit 10.20 to the Registrant's Annual Report on Form 10-K for the year ended December 31, 2003 (File No. 1-12001)).\*
- 10.8 Credit Agreement, dated July 31, 2007, by and among the Company, the guarantors party thereto, the lenders party thereto, PNC Bank, National Association, as Administrative Agent, and PNC Capital Markets LLC, as Lead Arranger (incorporated by reference to Exhibit 10.6 to the Registrant's Quarterly Report on Form 10-Q for the quarter ended March 31, 2010 (File No. 1-12001)).
- 10.9 Form of Amended and Restated Change in Control Severance Agreement, dated as of December 31, 2008 (incorporated by reference to Exhibit 10.10 to the Registrant's Annual Report on Form 10-K for the year ended December 31, 2008 (File No. 12001)).\*
- 10.10 Summary of Non-Employee Director Compensation Program (incorporated by reference to Exhibit 99.1 to the Registrant's Current Report on Form 8-K dated August 5, 2008 (File No. 1-12001)).

- 10.11 Administrative Rules for the Non-Employee Director Restricted Stock Program, effective as of May 2, 2007, as amended through May 7, 2010 (incorporated by reference to Exhibit 10.5 to the Registrant's Quarterly Report on Form 10-Q for the quarter ended March 31, 2010 (File No. 1-12001)).\*
- 10.12 Form of Performance/Restricted Stock Agreement dated February 21, 2008 (incorporated by reference to Exhibit 10.3 to the Registrant's Quarterly Report on Form 10-Q for the quarter ended March 31, 2008 (File No. 1-12001)).\*
- 10.13 First Amendment to Credit Agreement, dated May 29, 2009, by and among ATI Funding Corporation, TDY Holdings, LLC, the guarantors party thereto, the lenders party thereto and PNC Bank, National Association, as administrative agent for the lenders (incorporated by reference to Exhibit 10.7 to the Registrant's Quarterly Report on Form 10-Q dated March 31, 2010 (File No. 1-12001)).
- 10.14 Form of Key Executive Performance Plan Agreement dated February 18, 2009, including Key Executive Performance Plan, as amended February 18, 2009 (incorporated by reference to Exhibit 10.1 to the Registrant's Quarterly Report on Form 10-Q for the quarter ended March 31, 2009 (File No.1-12001)).\*
- 10.15 Form of Total Shareholder Return Incentive Compensation Program Award Agreement effective as of January 1, 2009 (incorporated by reference to Exhibit 10.2 to the Registrant's Quarterly Report on Form 10-Q for the quarter ended March 31, 2009 (File No.1-12001)).\*
- 10.16 Form of Performance/Restricted Stock Agreement dated February 18, 2009 (incorporated by reference to Exhibit 10.3 to the Registrant's Quarterly Report on Form 10-Q for the quarter ended March 31, 2009 (File No.1-12001)).\*
- 10.17 Administrative Rules for the Performance Equity Payment Program, effective as of January 1, 2010 (incorporated by reference to Exhibit 10.23 to the Registrant's Annual Report on Form 10-K for the year ended December 31, 2009 (File No. 1-12001)).\*
- 10.18 Form of Key Executive Performance Plan Agreement dated February 24, 2010, including Key Executive Performance Plan, as amended February 24, 2010 (incorporated by reference to Exhibit 10.1 to the Registrant's Quarterly Report on Form 10-Q for the quarter ended March 31, 2010 (File No.1-12001)).\*
- 10.19 Form of Total Shareholder Return Incentive Compensation Program Award Agreement effective as of January 1, 2010 (incorporated by reference to Exhibit 10.2 to the Registrant's Quarterly Report on Form 10-Q for the quarter ended March 31, 2010 (File No.1-12001)).\*
- 10.20 Form of Performance/Restricted Stock Agreement dated February 24, 2010 (incorporated by reference to Exhibit 10.3 to the Registrant's Quarterly Report on Form 10-Q for the quarter ended March 31, 2010 (File No.1-12001)).\*
- 10.21 Allegheny Technologies Incorporated 2007 Incentive Plan As Amended and Restated, effective May 7, 2010 (incorporated by reference to Exhibit 99.1 to the Registrant's Registration Statement on Form S-8 dated May 7, 2010 (File No 333-166628)).\*
- 10.22 Second Amendment to Credit Agreement, dated December 22, 2010, by and among ATI Funding Corporation, TDY Holdings, LLC, the guarantors party thereto, the lenders party thereto and PNC Bank, National Association, as Administrative Agent for the lenders (incorporated by reference to Exhibit 10.1 to the Registrant's Current Report on Form 8-K dated December 29, 2010 (File No. 1-12001)).
- 10.23 Consulting and Noncompetition Agreement between Allegheny Technologies Incorporated and Lynn D. Davis, effective as of February 2, 2011 (incorporated by reference to Exhibit 10.30 to the Registrant's Annual Report on Form 10-K for the year ended December 31, 2010 (File No. 1-12001)).\*
- 10.24 Form of Performance Equity Payment Program Deferred Salary Agreement dated January 3, 2011 (incorporated by reference to Exhibit 10.31 to the Registrant's Annual Report on Form 10-K for the year ended December 31, 2010 (File No. 1-12001)).\*
- 10.25 Form of Performance Equity Payment Program Restricted Stock Agreement dated January 3, 2011 (incorporated by reference to Exhibit 10.32 to the Registrant's Annual Report on Form 10-K for the year ended December 31, 2010 (File No. 1-12001)).\*
- 10.26 2011 Annual Incentive Plan (incorporated by reference to Exhibit 10.1 to the Registrant's Quarterly Report on Form 10-Q for the quarter ended March 31, 2011 (file No. 1-12001)).\*
- 10.27 Form of Performance/Restricted Stock Agreement dated February 24, 2011 (incorporated by reference to Exhibit 10.2 to the Registrant's Quarterly Report on Form 10-Q for the quarter ended March 31, 2011 (file No. 1-12001)).\*



- 10.28 Form of Total Shareholder Return Incentive Compensation Program Award Agreement effective as of January 1, 2011 (incorporated by reference to Exhibit 10.3 to the Registrant's Quarterly Report on Form 10-Q for the quarter ended March 31, 2011 (file No. 1-12001)).\*
- 10.29 Form of Key Executive Performance Plan Agreement dated February 24, 2011, including Key Executive Performance Plan, as amended February 24, 2011 (incorporated by reference to Exhibit 10.4 to the Registrant's Quarterly Report on Form 10-Q for the quarter ended March 31, 2011 (file No. 1-12001)).\*
- 10.30 Third Amendment to Credit Agreement, dated March 11, 2011, by and among ATI Funding Corporation, TDY Holdings, LLC, the guarantors party thereto, the lenders party thereto and PNC Bank, National Association, as Administrative Agent for the lenders (incorporated by reference to Exhibit 10.5 to the Registrant's Quarterly Report on Form 10-Q for the quarter ended March 31, 2011 (file No. 1-12001)).
- 10.31 Consulting and Noncompetition Agreement between Allegheny Technologies Incorporated and L. Patrick Hassey, dated as of May 1, 2011 (incorporated by reference to Exhibit 10.6 to the Registrant's Quarterly Report on Form 10-Q for the quarter ended March 31, 2011 (file No. 1-12001)).\*
- 10.32 Consulting and Noncompetition Agreement between Allegheny Technologies Incorporated and Jon D. Walton, dated as of May 1, 2011 (incorporated by reference to Exhibit 10.7 to the Registrant's Quarterly Report on Form 10-Q for the quarter ended March 31, 2011 (file No. 1-12001)).\*
- 10.33 Fourth Amendment to Credit Agreement, dated November 9, 2011, by and among ATI Funding Corporation, TDY Holdings, LLC, the guarantors party thereto, the lenders party thereto and PNC Bank, National Association, as Administrative Agent for the lenders (filed herewith).
- 10.34 Aircraft Time Sharing Agreement, effective as of January 1, 2012, by and between Allegheny Technologies Incorporated and Richard J. Harshman (filed herewith).
- 12.1 Computation of Ratio of Earnings to Fixed Charges (filed herewith).
- 21.1 Subsidiaries of the Registrant (filed herewith).
- 23.1 Consent of Ernst & Young LLP (filed herewith).
- 31.1 Certification of Chief Executive Officer required by Securities and Exchange Commission Rule 13a-14(a) or 15d-14(a) (filed herewith).
- 31.2 Certification of Chief Financial Officer required by Securities and Exchange Commission Rule 13a-14(a) or 15d-14(a) (filed herewith).
- 32.1 Certification pursuant to 18 U.S.C. Section 1350 (filed herewith).
- 101.INS XBRL Instance Document
- 101.SCH XBRL Taxonomy Extension Schema Document
- 101.CAL XBRL Taxonomy Extension Calculation Linkbase Document
- 101.DEF XBRL Taxonomy Extension Definition Linkbase Document
- 101.LAB XBRL Taxonomy Extension Label Linkbase Document
- 101.PRE XBRL Taxonomy Extension Presentation Linkbase Document

---

\* *Management contract or compensatory plan or arrangement required to be filed as an Exhibit to this Report.*

Certain instruments defining the rights of holders of long-term debt of the Company and its subsidiaries have been omitted from the Exhibits in accordance with Item 601(b)(4)(iii) of Regulation S-K. A copy of any omitted document will be furnished to the Commission upon request.

## SIGNATURES

Pursuant to the requirements of Section 13 or 15(d) of the Securities Exchange Act of 1934, the Registrant has duly caused this Report to be signed on its behalf by the undersigned, thereunto duly authorized.

ALLEGHENY TECHNOLOGIES INCORPORATED

Date: February 27, 2012

By                   /s/ Richard J. Harshman                    
Richard J. Harshman  
*Chairman, President and Chief Executive Officer*

Pursuant to the requirements of the Securities Exchange Act of 1934, this report has been signed below by the following persons on behalf of the Registrant and in the capacities and as of the 27th day of February, 2012.

<u>                  /s/ Richard J. Harshman                  </u> Richard J. Harshman <i>Chairman, President and Chief Executive Officer and Director</i>	<u>                  /s/ Dale G. Reid                  </u> Dale G. Reid <i>Executive Vice President, Finance and Chief Financial Officer (Principal Financial Officer)</i>
	<u>                  /s/ Karl D. Schwartz                  </u> Karl D. Schwartz <i>Controller and Chief Accounting Officer (Principal Accounting Officer)</i>
<u>                  /s/ Diane C. Creel                  </u> Diane C. Creel <i>Director</i>	<u>                  /s/ John R. Pipski                  </u> John R. Pipski <i>Director</i>
<u>                  /s/ James C. Diggs                  </u> James C. Diggs <i>Director</i>	<u>                  /s/ James E. Rohr                  </u> James E. Rohr <i>Director</i>
<u>                  /s/ J. Brett Harvey                  </u> J. Brett Harvey <i>Director</i>	<u>                  /s/ Louis J. Thomas                  </u> Louis J. Thomas <i>Director</i>
<u>                  /s/ Barbara S. Jeremiah                  </u> Barbara S. Jeremiah <i>Director</i>	<u>                  /s/ John D. Turner                  </u> John D. Turner <i>Director</i>
<u>                  /s/ Michael J. Joyce                  </u> Michael J. Joyce <i>Director</i>	



## ATI Corporate Executive Management

### Richard J. Harshman

*Chairman, President and Chief Executive Officer*

### Dale G. Reid

*Executive Vice President, Finance and Chief Financial Officer*

### Elliot S. Davis

*Senior Vice President, General Counsel, Chief Compliance Officer and Corporate Secretary*

### Carl R. Moulton

*Senior Vice President, International*

## ATI Segments and Business Units

### Hunter R. Dalton

*Executive Vice President Long Products, and President, ATI Allvac*

### Terry L. Dunlap

*Executive Vice President, Flat-Rolled Products, and President, ATI Allegheny Ludlum*

### David M. Hogan

*Executive Vice President, Engineered Products Segment*

#### Michael L. Cleppe

*President, Engineered Products Group*

- ATI Portland Forge
- ATI Precision Finishing
- ATI Casting Service
- ATI Fabricated Components

#### Robert S. Wetherbee

*President, ATI Tungsten Materials*

### John D. Sims

*Executive Vice President, Primary Metals and Exotic Alloys and President, ATI Wah Chang*

### Gary J. Vroman

*Executive Vice President, High Performance Forgings and Castings and President, ATI Ladish*

## ATI Corporate Management



### Dan L. Greenfield

*Vice President, Investor Relations and Corporate Communications*



### Rose Marie Manley

*Treasurer*



### Lauren S. McAndrews

*Vice President, Labor Relations and Assistant General Counsel*



### Mary Beth Moore

*Vice President, Human Resources*



### Karl D. Schwartz

*Controller and Chief Accounting Officer*

*ATI, ATI 425, ATI 2003, ATI 2102, 718Plus, SuperTough, Datalloy 2, AL-6XN, AM 350, ATI 500-MIL, Precision Rolled Strip, OmegaBond, Densalloy, Starburst logo, "Mission Critical Metallics" and "Building the World's Best Specialty Metals Company" are registered trademarks of ATI Properties, Inc.*

*Zeron is a registered trademark of Rolled Alloys UK Ltd.*

*PurePower and Waspalloy are registered trademarks of Pratt & Whitney.*



**Richard J. Harshman**



**Diane C. Creel**



**James C. Diggs**

**Richard J. Harshman**

*Chairman, President and Chief Executive Officer of Allegheny Technologies Incorporated*

**Diane C. Creel\***

*Retired Chairman, Chief Executive Officer and President of Ecovation, Inc., a waste stream technology company using patented technologies 2, 3, 4*

**James C. Diggs**

*Retired Senior Vice President and General Counsel of PPG Industries, Inc., a producer of coatings, glass and chemicals 1, 2, 3*



**J. Brett Harvey**



**Barbara S. Jeremiah**



**Michael J. Joyce**

**J. Brett Harvey**

*Chairman and Chief Executive Officer of CONSOL Energy, Inc., a leading diversified fuel producer in the Eastern United States 3, 4*

**Barbara S. Jeremiah**

*Retired Executive Vice President and Chairman's Counsel of Alcoa, Inc., a leading aluminum producer 1, 5*

**Michael J. Joyce**

*Retired New England Managing Partner of Deloitte & Touche USA LLP, a public accounting firm 1, 2*



**John R. Pipski**



**James E. Rohr**

**John R. Pipski**

*Retired tax partner of Ernst & Young LLP, a public accounting firm 1, 5*

**James E. Rohr**

*Chairman and Chief Executive Officer of The PNC Financial Services Group, Inc., a diversified financial services organization 4*



**Louis J. Thomas**



**John D. Turner**

**Louis J. Thomas**

*Retired Director, District 4, United Steelworkers 1, 5*

**John D. Turner**

*Retired Chairman and Chief Executive Officer of Copperweld Corporation, a manufacturer of tubular and bimetallic wire products 1, 2, 5*

*\*Lead Independent Director*

**Standing Committees of the Board of Directors:**

- 1 Audit Committee
- 2 Finance Committee
- 3 Nominating and Governance Committee
- 4 Personnel and Compensation Committee
- 5 Technology Committee

**Corporate Headquarters**

1000 Six PPG Place  
Pittsburgh, PA 15222-5479  
412-394-2800

**Annual Meeting**

The Annual Meeting of Stockholders will be held on May 11, 2012 at 11:00 a.m. Grand Ballroom, 17th Floor Omni William Penn Hotel 530 William Penn Place, Pittsburgh, PA 15219

**Transfer Agent and Registrar**

Computershare (formerly BNY Mellon)  
P.O. Box 358015  
Pittsburgh, PA 15252-8015  
or  
480 Washington Boulevard  
Jersey City, NJ 07310-1900  
1-800-406-4850  
[www.bnymellon.com/shareowner/equityaccess](http://www.bnymellon.com/shareowner/equityaccess)  
(Information about dividend checks, dividend tax information, and stock certificates, including lost or unexchanged certificates)

**Investor Services Program**

Computershare (formerly BNY Mellon) offers an Investor Services Program for current stockholders and interested investors which includes:

- Voluntary purchases of Allegheny Technologies common stock for new investors and current stockholders
- Dividend reinvestment
- Direct deposit of dividends into your personal checking, savings or other account
- Safekeeping of stock certificates at no charge

To request Program information and enrollment forms, call: 1-866-353-7849

To ask about the Program or your Program account, contact:

Computershare (formerly BNY Mellon)  
P.O. Box 358035  
Pittsburgh, PA 15252-8035  
1-800-406-4850

**Stockholder Publications**

Annual reports and proxy statements are mailed to all stockholders of record. These publications and Reports on Form 10-K and Form 10-Q and other information may also be obtained through the Company's website [www.ATImetals.com](http://www.ATImetals.com).

For additional information contact:  
Investor Relations and Corporate Communications at corporate headquarters, or by calling 412-394-3004.

**Independent Auditors**

Ernst & Young LLP  
Pittsburgh, PA

**Form 10-K**

The Company submits an annual report to the Securities and Exchange Commission (SEC) on Form 10-K. Copies of the Form 10-K are available upon written request to the Corporate Secretary at the corporate headquarters.

**Stock Exchange Listing**

The common stock of Allegheny Technologies Incorporated is traded on the New York Stock Exchange (symbol ATI). Options on the Company's stock are traded on the American Stock Exchange, the Chicago Board of Options Exchange, the Pacific Exchange, and on the Philadelphia Stock Exchange.

**Internet Home Page**

Allegheny Technologies' Internet home page can be found at [www.ATImetals.com](http://www.ATImetals.com).

Please visit our website for more information on the Company, our products and operations. On this site you can find our news releases and SEC filings, and obtain instructions on how to transfer ownership of your stock, sign-up for the Investor Services Program, directly deposit your dividend check, change your dividend payment information and locate tax reporting information.





Corporate Headquarters  
1000 Six PPG Place  
Pittsburgh, PA 15222-5479  
U.S.A.  
412-394-2800  
[ATImetals.com](http://ATImetals.com)

© 2012 ATI