



Wacker Chemie AG

WACKER

Annual Report 2008
Paths to Globality

WACKER at a Glance

		2008	2007	Change in %
Results/Return				
Sales	€ million	4,298.1	3,781.3	13.7
EBITDA	€ million	1,055.2	1,001.5	5.4
EBIT	€ million	647.9	649.6	-0.3
Net income	€ million	438.3	422.2	3.8
Earnings per share	€	8.84	8.49	4.1
ROCE	%	25.7	25.3	
Balance Sheet/Cash Flow				
Total assets	€ million	4,625.1	3,918.1	18.0
Equity	€ million	2,082.8	1,865.6	11.6
Equity ratio	%	45.0	47.6	
Capital expenditures (including financial assets)	€ million	916.3	699.3	31.0
Depreciation (including financial assets)	€ million	407.3	351.9	15.7
Net cash flow	€ million	21.7	643.7	-96.6
Research and Development				
Research and development expenses	€ million	163.2	152.5	7.0
Employees				
Personnel expenses	€ million	1,086.0	1,014.9	7.0
Employees (December 31)	Number	15,922	15,044	5.8

Mission

WACKER is a leader in the chemical and semiconductor sectors, pushing ahead with technical innovations and the development of new products for the world's key industries. In this way, the company helps improve people's lives. WACKER is organized as a group of independently operating units with extensive responsibility under one strong roof – this provides the necessary flexibility and resolve. Everything we do is conducive to global networking and cultural integration.

Vision

The chemical industry makes a vital, long-term contribution to global progress and sustainable development. Future social and economic success will rest more than ever on worldwide collaboration and interconnected competencies. Thus, the best way of mastering today's and tomorrow's challenges is through flexible and specialized units that can also profit from the opportunities.



Crystal-Clear Visibility

...// Leak-tight, skin-compatible and stable, a crystal-clear ELASTOSIL® silicone rubber grade in swimming goggles ensures good visibility for underwater fun. This is just one of many product applications from WACKER SILICONES, a world-leading silicone manufacturer.

Dear Shareholders,

On May 8, 2008, I became President and CEO of Wacker Chemie AG's Executive Board. So, this is the first time I am writing to you in this capacity. Although 2008 posed additional challenges, we forged ahead seamlessly, after a successful 2007. WACKER was able to post new sales and earnings records. As a result, we met the goals we set at the start of 2008. This would not have been possible without WACKER's employees and customers. So, I would like to extend my sincere thanks to all of them.

Compared with the previous year, sales rose to €4.3 billion, up 14%. EBITDA climbed to €1.06 billion, though earnings were impacted by high energy and raw material costs, not to mention exchange rate fluctuations. A key aspect of our growth strategy is production capacity expansion. In particular, we profit from the solar sector's rising polysilicon demand. Our "Expansion Stage 7" polysilicon production facility went on stream six months earlier than planned, which meant it could supply its first large quantities to customers early. The project spotlights our excellent engineering expertise – which we have built up over several decades. Despite the complex nature of WACKER plants, our expertise has repeatedly allowed us to meet or even outperform our ambitious schedules. We are also making good progress with our projects to establish Chinese facilities in Nanjing and Zhangjiagang. Pyrogenic silica production has been on stream in Zhangjiagang since November 2008.

2008 saw us concluding integration of the dispersion business previously operated by Air Products – our former long-time partner. When our Nanjing production site comes on stream in 2009, we will be the only company on the market to offer a complete supply chain for dispersions and polymer powders in Asia, Europe, and the Americas.

Due to our expansion program and the dispersion acquisition, our investment volume rose strongly once more compared with the previous year. For the first time in WACKER's history, investments passed the €1 billion mark. We funded these investments entirely out of our own cash flow. In spite of high investment levels in 2008, the Group is soundly financed and has an excellent equity base. Cash and cash equivalents exceed current and noncurrent financial liabilities. WACKER is, thus, almost free of debt – an increasingly important factor in light of the financial crisis.

Of course, we will certainly have our shareholders participate appropriately in last year's success. In times of financial crisis, however, it is equally important to bolster WACKER's internal financial strength and take account of 2009's general economic challenges. This is why we are proposing a dividend of €1.80 per share at the Annual Shareholders' Meeting in May 2009. Relative to net income, 2008's payout ratio is 20.4 %.

Turning to our goals for 2008, we can be satisfied with our overall performance. Nonetheless, 2008 had two sides to it. In the first half, the growth pattern of previous years continued. The trend in the second half, though, was exactly the opposite. Q4, in particular, saw almost every industry worldwide being affected by plummeting demand and sales. WACKER was not immune to the consequences.

The severity of the downturn took everyone by surprise. Given the scope of the current trend, I would like to answer a few questions that have been raised not only by WACKER shareholders such as yourselves, but also by our employees, customers, suppliers, and the Executive Board itself. What impact will the global economic crisis have on WACKER's business? Will we stick to our growth strategy?

WACKER may not be immune to the global slump. However, we are in a position to influence its impact on us. This is why we took action back in 2008 and approved crisis-alleviating measures, such as short-time work, temporary plant shutdowns, budget cuts, investment plan modifications, and especially sound operational financing. Other positive effects are likely from raw material and energy costs, which we expect to be lower than in 2008.

Based on current economic developments, we expect to see sales and operating result decline in 2009, although it is still hard to say by how much. Bearing this in mind, a reliable forecast is not yet possible. We will discuss 2009 more specifically as part of our quarterly reporting. Despite the difficult economic situation, there is still growth potential in our WACKER POLYSILICON and WACKER FINE CHEMICALS divisions.

Once the global economy has come out of recession, WACKER will vigorously resume its growth path. After all, WACKER does not have a general structural problem. What we are facing is primarily a severe, cyclical drop in demand.

Although 2009 will not be an easy year, we will continue our long-term growth strategy. We will maintain our high level of investments so that we can tap into growth potential, especially in the solar sector. Our approach is underscored not only by the decision to build another polysilicon plant in Nünchritz (Germany), but also by our announcement in late February 2009 to set up a new integrated polysilicon production site in the USA.

As you can see, we are optimistic about WACKER's future. The major megatrends from which we profit remain unchanged. We have a unique product portfolio for energy conservation and sustainable energy generation. The same

goes for WACKER's myriad of cutting-edge products that help to both raise the standard of living in emerging economies and keep it high in industrialized countries. Thus, we make a key contribution to global progress and sustainable development. For years, sustainability has been an integral part of our production and business processes. In 2008, for example, we received the Federation of German Industry's Environmental Award for our biotech-engineered production of cysteine (an amino acid).

We have an excellent global position and outstanding production and plant expertise. Our customer relations are first-rate and go back many years. These are all strengths that will continue to play a vital role in maintaining WACKER's long-term success. My Executive Board colleagues and I will be doing everything we can to achieve this goal.

Dr. Rudolf Staudigl

A handwritten signature in black ink, appearing to read 'R. Staudigl', written in a cursive style.

President & CEO of Wacker Chemie AG

Executive Board

Dr. Rudolf Staudigl
President & CEO

WACKER SILICONES

Executive Personnel, Corporate Development, Corporate Communications, Investor Relations,
Corporate Auditing, Legal & Insurance, Corporate R&D, Intellectual Property

Dr. Joachim Rauhut

WACKER POLYSILICON

Corporate Accounting, Corporate Controlling, Corporate Finance, Information Technology
Raw Materials Procurement, Technical Procurement & Logistics, Tax
Regions: Europe, NAFTA

Dr. Wilhelm Sittenthaler

(from May 8, 2008)

SILTRONIC

Human Resources (Personnel Director)
Region: Asia/Pacific

Auguste Willems

WACKER POLYMERS, WACKER FINE CHEMICALS

Corporate Engineering, Sales & Distribution, Site Management, Corporate Security
Regions: Middle East, India, South America



[Dr. Joachim Rauhut]

[Auguste Willems]

[Dr. Rudolf Staudigl]

[Dr. Wilhelm Sittenthaler]

Paths to Globality

WACKER generates nearly 80% of its sales outside Germany and is thus already today a globally-oriented enterprise. Our products are sold worldwide. We work to the same standards of sustainability, environmental protection and occupational safety throughout the world.

When it comes to individual markets, products or customers, we think locally. Our philosophy is that the focus of responsibility for day-to-day business lies within the region – with the people who know their customers. The better our understanding of markets, customers and cultures, the better we are able to recognize and meet their requirements. We are convinced that businesses which operate according to this principle will enjoy long-term success.

This annual report takes four examples to illustrate WACKER's global orientation, the routes we have taken along the way and the understanding with which we are meeting an increasingly globalized world.

WACKER Worldwide Sites

2 The Americas

01 USA

Adrian / Michigan ██████████
 Allentown / Pennsylvania ██████████
 Austin / Texas ██████████
 Calvert City / Kentucky ██████████
 Chino / California ██████████
 Duncan / South Carolina ██████████
 Eddyville / Iowa ██████████
 North Canton / Ohio ██████████
 Portland / Oregon ██████████
 San José / California ██████████
 South Brunswick / New Jersey ██████████

02 Mexico

Mexico City ██████████

03 Brazil

Jandira / São Paulo ██████████



Europe

04 Sweden

Solna ██████████

05 Great Britain

Chertsey ██████████

06 Netherlands

Krommenie ██████████

07 Russia

Moscow ██████████

08 Poland

Warsaw ██████████

09 Czech Republic

Plzeň ██████████

Prague ██████████

10 France

Lyon ██████████

11 Spain

Barcelona ██████████

12 Hungary

Budapest ██████████

13 Italy

Milan ██████████

14 Ukraine

Kiev ██████████

15 Turkey

Istanbul ██████████

16 Greece

Athens ██████████

17 Germany

Alzenau ██████████

Burghausen ██████████

Cologne ██████████

Freiberg / Saxony ██████████

Jena ██████████

Kempton ██████████

Munich ██████████

Nünchritz ██████████

Stetten ██████████

Stuttgart ██████████

Paths to Globality When Wacker-Chemie GmbH was founded in October 1914, it didn't immediately venture out into the world. The initial focus was on building up process expertise at the WACKER plant in Burghausen and on emerging from its humble beginnings to become a market force. Over 40 years passed before WACKER's first foreign subsidiary – Milan-based Società Chimica Ravenna S.p.A. – was founded in 1958. By then, WACKER had established its credentials as a producer of specialty chemicals, with strong roots in its native Bavaria. At that time, foreign sales accounted for €12 million or 10.7% of total sales worth €113 million. WACKER's international network continued to expand, particularly throughout the 1970s and 1980s. Today, WACKER is at home anywhere in the world. Our global production, sales and service network covers all key regions, as is clear from the map.

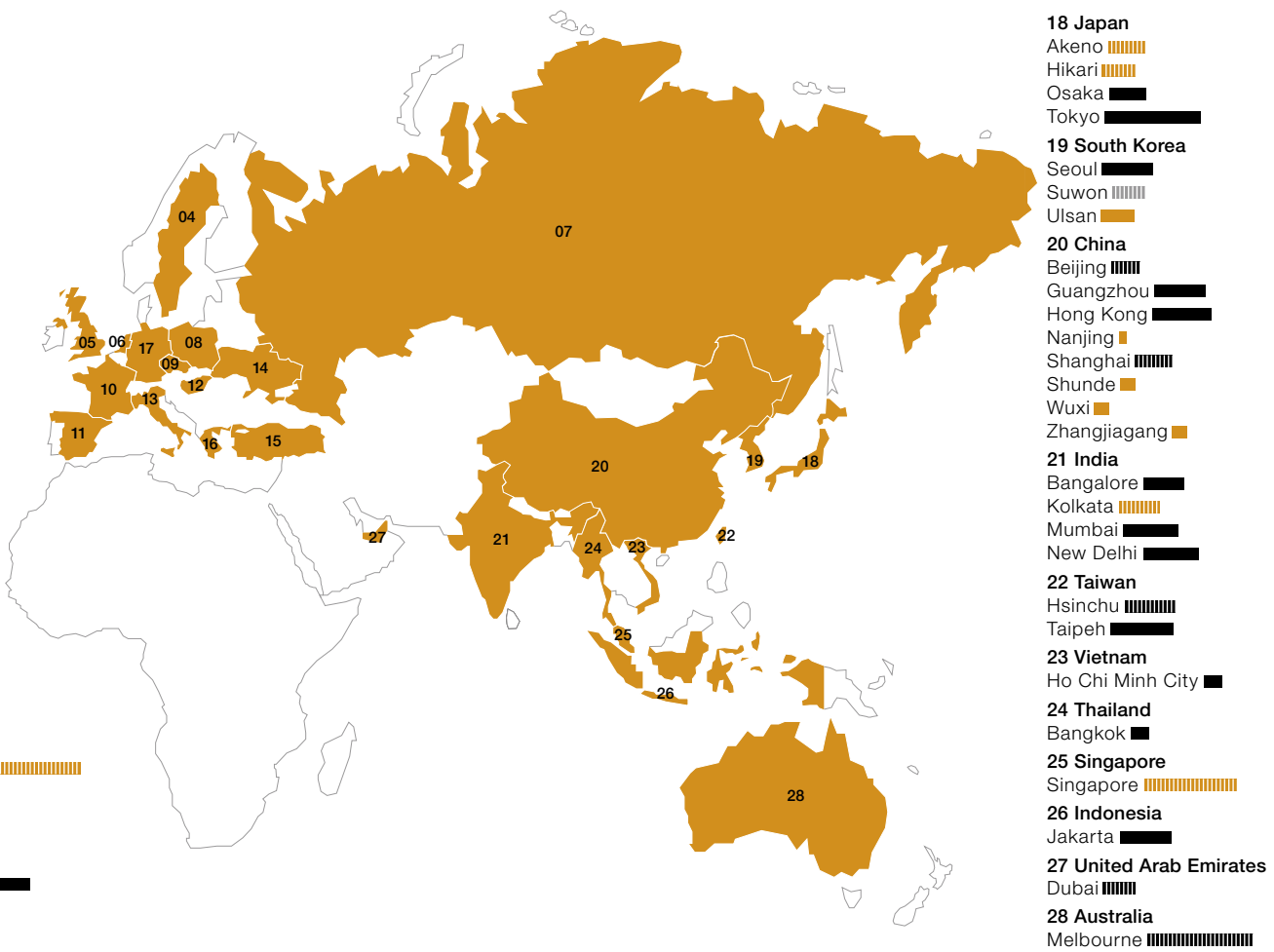

■■■■■ Production sites with technical center
 ■■■■■ Non-production sites with technical center
 ■■■■■ Technical center

■ Production sites
 ■ Non-production sites

0 50 Years of Operation

4 7:15 a.m. ...

01

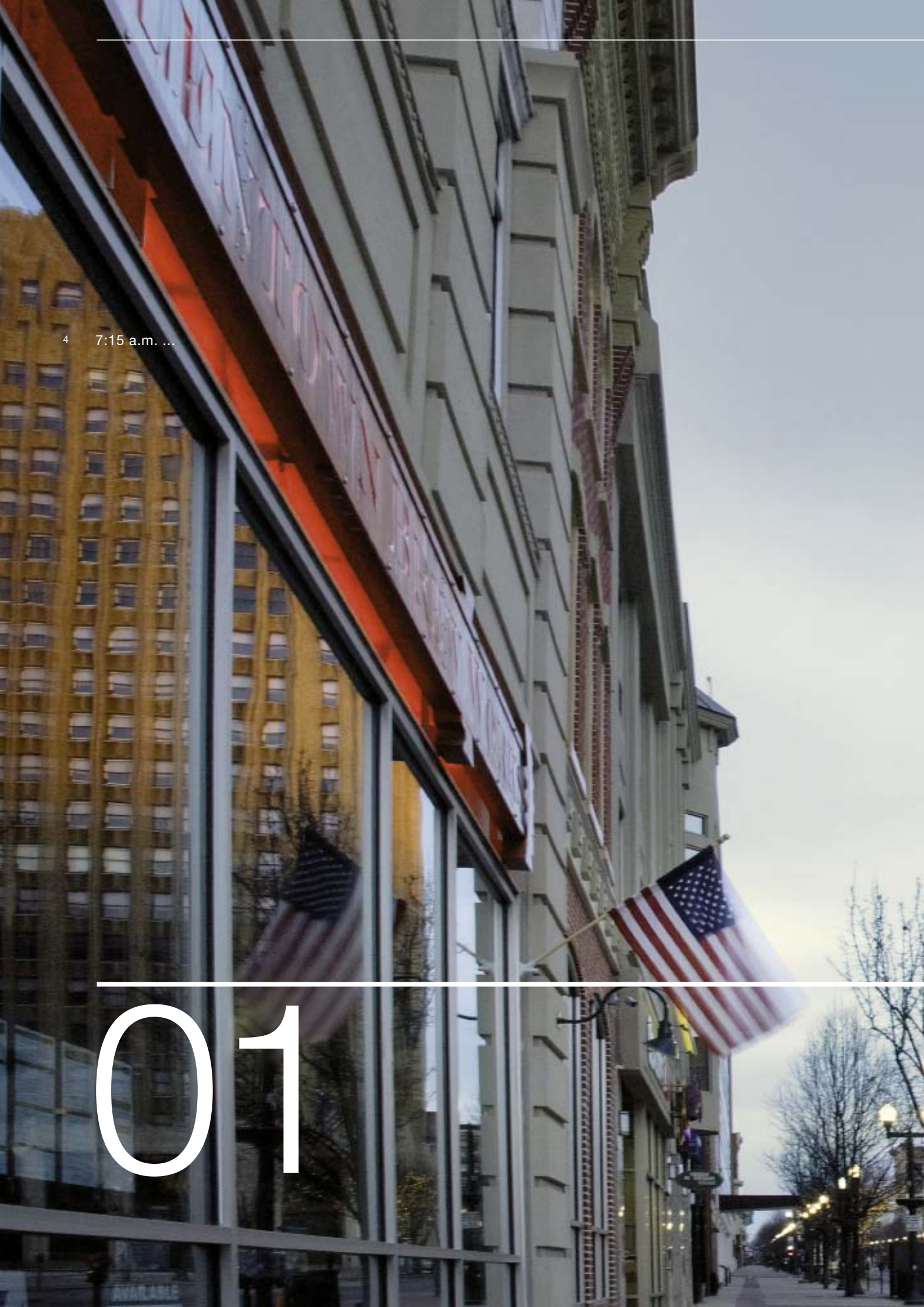



Allentown/Pennsylvania, USA 5

Sleepless in Allentown. WACKER's Global Dispersions Business Has Found a New Home in a Mid-Size American City.

The residents of Allentown like to say that “This place is in balance.” The Lehigh River meanders through the tranquil city, the third largest in the state of Pennsylvania; the woods and mountains are just a stone’s throw away. Allentown isn’t small, but it’s not big either. It’s not frenetic, but neither is it quiet, and it’s little more than an hour and a half’s drive to vibrant Manhattan. To its 100,000 residents, the city is a great place to live and work – a view shared by WACKER. Since early 2008, the future headquarters for WACKER POLYMERS in the America region has been under construction in Allentown. As a one-stop supplier, the WACKER Group now provides customers with polymer dispersions and dispersible polymer powders on three continents.

Although he’s 100% American, WACKER manager John Tacca greets us with the southern German greeting “Grüß Gott.” His accent adds an extra dose of charm to the affable reception. He sips his coffee and places his cup gently back on his desk, right next to a photograph of his wife and four sons. It’s 8 a.m. in Allentown, and he’s just out of a teleconference with his colleagues in Asia. Tacca, a chemical engineer by training, seems wide awake, though it would be understandable if he were a little tired right now.

The 48-year-old clocked up well over 300,000 air miles in 2008, helping to organize the buyout of the stake held by Air Products and Chemicals (APCI) in two companies which had been run for almost ten years as joint ventures between APCI and WACKER. Much has changed. WACKER’s entire global dispersions business has been consolidated into a new business unit, headquartered in Allentown. John Tacca, who has lived here with his family

[Sector] The Dispersions business unit is part of the WACKER POLYMERS business division, a global leader in polymer binders and additives. In 2008, WACKER POLYMERS employed 1,579 people world-wide and posted sales of €867.9 million and an EBITDA of €108.9 million.

01. 1 It's rare for John Tacca to be working at his desk – much of the time he's away on business.

7



[The Raw Material] Ethylene is a colorless, slightly sweet-smelling, flammable gas. It is one of the most important raw materials for organic chemistry and is the starting point for about 30% of all petrochemicals. Ethylene is used in the manufacture of plastics such as polyethylene, polyvinyl acetate, cellulose acetate and polyvinyl chloride.



since 1982, is head of the global dispersions business. In addition to his role as global BU head for dispersions, he is also responsible for WACKER's polymer operations in North America, where the company now offers a complete portfolio for end products such as exterior insulation and finish systems, paints, adhesives and coatings – similar to the setup in South Korea and Europe.

The “one-stop supplier” strategy is aimed at bringing WACKER POLYMERS closer to its customers and increasing the level of value-added support. Product development, especially development of dispersible polymer powders, will be strengthened, and the skills and capabilities obtained through the complete takeover of the joint ventures will create enhanced opportunities for tailoring development to prevailing market conditions. John Tacca is convinced that “We are closer than ever to our customers.” Nevertheless, every takeover has its uncertainties, not least for the workforce, and this acquisition has been no exception, involving a new structure and organizational changes. The takeover has been particularly radical for the production facilities in South Brunswick, New Jersey, as WACKER is consolidating the whole of its North American manufacturing in Calvert City, Kentucky. John Tacca is, however, sure of one thing: “It's the best, most efficient solution.” Even so, around 40 staff members will not be making the journey from New Jersey to Kentucky. WACKER is supporting them through retraining and helping them find new jobs.

Little Things Have a Big Effect. For the 100-plus staff in Allentown, there is plenty of reason to be optimistic. “WACKER has a great reputation,” says Tacca, adding that, “The company is known around here for strong, sustainable growth and a commitment to long-term success.” Taking things one step at a time, WACKER has, over the last twelve months, been showing its employees that the company respects their skills and capabilities. As John Tacca recalls, it's been the little things that have sometimes had the greatest effect on staff – Dr. Peter-Alexander Wacker traveling to Allentown in person to announce the impending acquisition in late 2007, for instance. There have also been a number of subsequent visits from WACKER's Executive Board members. “That makes an impression,” notes Tacca, “Down-to-earth, communicative senior management is highly welcomed in America.”

[One-Stop Supplier] For ten years, Air Products Polymers and Wacker Polymer Systems were run as joint ventures between WACKER and US-based Air Products and Chemicals. On February 1, 2008, WACKER acquired Air Products and Chemicals' stake in their joint vinyl acetate ethylene activities, and now offers polymer dispersions and dispersible polymer powders on three continents as a one-stop supplier.



01. 3 – 4 New products for the dispersions business are created in the Allentown labs.

9

There's also been a well-structured approach to integrating staff and business processes. The IT department is a good example of this. More than 100 different IT systems had to be combined and adapted to enable collaboration. Worldwide, a total of 18 project teams were involved, with the project successfully concluding in August 2008. Pretty extraordinary given that a lot of takeovers fail as a result of IT-related factors. "Our most important weapon was communication," explains John Tacca, "by means of regular, well-planned teleconferences, for example." All team members then knew exactly what was expected of them and what they had to do. Problems were tackled as and when they emerged. The result has been that, from the customer's point of view, the transition period – from ordering to delivery and invoicing – passed without a hitch.

The Gateway to the Big, Wide World. The mood among staff is excellent, too, explains John Tacca, who doesn't, however, play down the difficulties involved in the integration process, "People who have been working for another company for many years aren't going to feel part of WACKER overnight." WACKER will take a key step toward helping them feel part of the company in the near future, with the creation of a new headquarters in Allentown between now and fall 2009. At the same time, the site will, as the lynchpin of WACKER's reorganized dispersions business, be a key component of the global business. "Integration into WACKER and the creation of a new business unit raises the international profile of our activities," says John Tacca. Germany, South Korea and China are just as important to the new business unit as the US. This presents the team with both new challenges and new career opportunities. This will become clear for all to see if, for example, a US employee takes up the post of laboratory head as part of a new project in China, explains John Tacca, who himself spent several years working in Cologne. "International guests from every corner of the world will visit Allentown," says Tacca, adding with a smile, "Sounds good, doesn't it? Allentown: Gateway to the World!"

[Products] Polymer dispersions and dispersible polymer powders are based on vinyl acetate ethylene compounds or vinyl chloride ethylene compounds. WACKER supplies dispersions and dispersible powders for use in construction, binders, coatings, engineered fabrics and other industrial applications.

10 12 noon ...

02



Singapore's Melting Pot. Silicon Wafers for the Global Market from Southeast Asia, Manufactured by an Extraordinary Multinational Team.

Almost 4.8 million people live in the vibrant metropolis of Singapore, 1.2 million of them foreign workers from around the world. It takes just an hour to cross the island by car, but, despite being crowded, the Southeast Asian island nation is a place of harmony. This is where, in an industrial zone, WACKER subsidiary Siltronic and the Samsung Group have set up a 300 mm silicon wafer fab. Singapore's multicultural melting pot is the perfect location for this multinational enterprise. Here in Singapore, WACKER is showing just how top-notch global collaboration ought to work. German-Korean subsidiary Siltronic Samsung Wafer (SSW) is headed by an American, two Koreans and a Japanese. Singapore offers optimal access to the growing Asian market, in particular to major customers in Taiwan, China, South Korea, Singapore and Japan. Three quarters of global 300 mm wafer production is used in Asia.

A last piece of bright orange, ripe papaya, a sip of chilled cola and David Wilhoit has finished his lunch. The 41-year-old leans back and looks around the room. The air is filled with the smell of curry, soy sauce and fresh fruit. Wilhoit exchanges a few words with a Chinese staff member, rises and picks up his tray. The American executive walks past Koreans, Germans, Austrians, Chinese, Japanese, Indians and Malaysians seated at long tables, to the end of the canteen, where he pauses for a moment. Signs saying "halal" and "non-halal" hang above the tray racks – the Muslim faith not only forbids the consumption of pork, but also the use of plates or trays on which pork has been served. A visit to the canteen at Siltronic Samsung Wafer (SSW) illustrates what it is that makes the Singapore-based German-Korean joint venture so unusual – its colorful mix of religions, nationalities

[Sector] Siltronic is a subsidiary of Wacker Chemie AG and a leading global supplier of silicon wafers to nearly all the major chip manufacturers. Siltronic has 5,469 employees worldwide and posted sales of €1.36 billion in 2008. Its EBITDA was €357.3 million.

02. 1 David Wilhoit makes good use of the taxi ride to work.

13



[Expatriate Strategy] The company dispatches existing staff for many overseas management positions, enabling them to gain greater familiarity with markets and subsequently to make use of their experiences in other positions at WACKER. The current crop of around 50 expats is contributing to improving intercultural understanding within the WACKER Group.



and cultures. David Wilhoit is CEO of a business which, in the final expansion phase, will employ 800 staff to manufacture around 300,000 of the latest generation of 300 mm wafers per month. Managing an enterprise with 13 nationalities, six religions, and over ten languages and dialects requires intercultural understanding, skill and tact in dealing with people, and a willingness to reach mutual agreement, explains Wilhoit. The only decorations in his spartan office are some photographs in a display cabinet of his wife and two daughters and a mirror-smooth ball of silicon. Wilhoit is the right man for this job – he has worked for WACKER in the US, Singapore and Japan for 18 years. When two successful companies come together, international experience is essential. “The process doesn’t just take care of itself,” notes Wilhoit, who prepared himself for Korean business culture with an intercultural training course – where he learned a great deal.

Trust Matters. Wilhoit reports, for example, that when it comes to working together with Koreans, it is essential to establish a close relationship before getting down to actual negotiations. “There were lots of informal meetings between marketing, finance and technology managers, which were all about building trust.” The entire senior management team still goes for a game of mini golf together or organizes a golf tournament in which different departments are mixed to compete against each other. “A lot of minor issues can be handled quickly and easily at an informal level,” says Wilhoit, who co-heads the enterprise together with a Japanese colleague from Siltronic and two Koreans from Samsung.

First Listen, then Decide. What sounds like a recipe for gridlock at the senior management level is, in Wilhoit’s view, an advantage in helping to bridge the gap between the two corporate cultures, “The division of responsibility forces us to work together closely and not make decisions over each other’s heads.” This requires good listening and communication skills, explains the seasoned executive. This approach is generally pretty straightforward, primarily because the two equal partners enjoy plenty of benefits from the arrangement. Despite the fluctuations in the semiconductor industry, SSW is, even during slower periods, able to make adequate use of fab capacity, keep costs to a mini-

[Market] Production capacity for silicon wafers is falling in the USA and Europe, as local markets are shrinking. By contrast, Singapore is the right location for Siltronic Samsung Wafer’s investment. The Asian market is growing, with companies there processing 75% of global 300 mm wafers.



02. 3 – 4 Modernity and tradition are characteristic of life in Singapore.

15

mum and work efficiently, explains Wilhoit, adding, “We’re also sufficiently flexible and agile to be able to maximize output during the stronger periods.” WACKER and Siltronic ensure a reliable supply of raw materials and provide wafer technology; Samsung purchases a large portion of the output. This is the first time a wafer manufacturer and a semiconductor manufacturer have worked so closely together.

Learning from One Another. SSW sells the remainder of its output to other customers, including some of Samsung’s competitors. “Only having one customer tends to give you tunnel vision,” asserts Wilhoit. A wider range of customers lets you keep a better eye on the market and predict market developments. The flip side is that specific precautions need to be taken, “We have to conform to strict confidentiality regulations to ensure that Samsung’s and our other wafer customers’ proprietary information remains confidential.” Fab design is another area where Samsung and Siltronic have learned from each other. The basic design makes use of WACKER subsidiary Siltronic’s substantial experience in this area. “On the other hand, Samsung, as our partner and major customer, has contributed its production expertise,” says David Wilhoit. Factory automation using overhead hoist transport and FDC (fault detection and classification) methodology, for example, are new to Siltronic. Our customers expect high-quality products – something which is definitely not up for negotiation. Quality of staff is also crucial to SSW’s success and was a key factor in deciding on a location for the fab. “Engineers in Singapore are very well trained,” says Wilhoit, adding that the success of Singapore’s business policy also has a downside. Because the economy is growing so strongly, there’s a real fight for talented people, “We work hard to retain people once we’ve got them.” His approach includes meeting new staff in person on their first day, outlining corporate philosophy, and making sure they get to know him and the company. With a smile, the SSW president recalls one particular introduction. Shortly after he joined, the company rented a cinema for the staff. “The film we watched was ‘Meet Dave’ with Eddie Murphy,” explains David Wilhoit. “No one seemed to believe me that it was just pure coincidence.”

[Product] The 300 mm wafers which Siltronic Samsung Wafer manufactures are currently the largest and most advanced wafers manufactured for use in commercial semiconductor production. Semiconductor manufacturers use them to produce transistors, rectifiers, microprocessors and memory modules for products such as cellphones, game consoles and computers.

16 3 p.m. ...

03

OLA

Training for a Big Country. Russia Is Big, the Climate Extreme, and Its Customers Demanding. The Only Solution Is to Learn, Learn and Then Learn Some More.

With 15 million inhabitants, Moscow plays a key role in the Russian economy. 20% of Russian GDP is created in the capital. Five years ago, WACKER set up a technical center in Moscow to develop and test product formulations for the construction industry under local climatic conditions. Since late 2008, the range of services WACKER provides in Europe's largest city has been supplemented by the VINNAPAS® ACADEMY, our training center for the crucial Russian market, where WACKER customers can acquire theoretical and practical knowledge of the use of polymers in the construction industry.

Dmitrij Firsaev's office is in the second story of an office building at an old paint factory. VINNAPAS® ACADEMY's training manager in Moscow took a degree at the capital's Russian University for Chemical Technology, started work with WACKER at its Moscow technical center and has worked in the laboratory and on site for customers throughout the region. In this interview, the 25-year-old manager talks about plans for the new training center, located just 15 minutes by subway from the Kremlin.

[Sector] WACKER is the world's largest manufacturer of dispersible polymer powders. With 1,579 employees, the WACKER POLYMERS business division has been producing polymer powders and dispersions for the construction industry for more than 50 years. In 2008, WACKER POLYMERS generated sales of €867.9 million and an EBITDA of €108.9 million.

03. 1 The VINNAPAS® ACADEMY is just a few minutes by subway from Red Square.

19

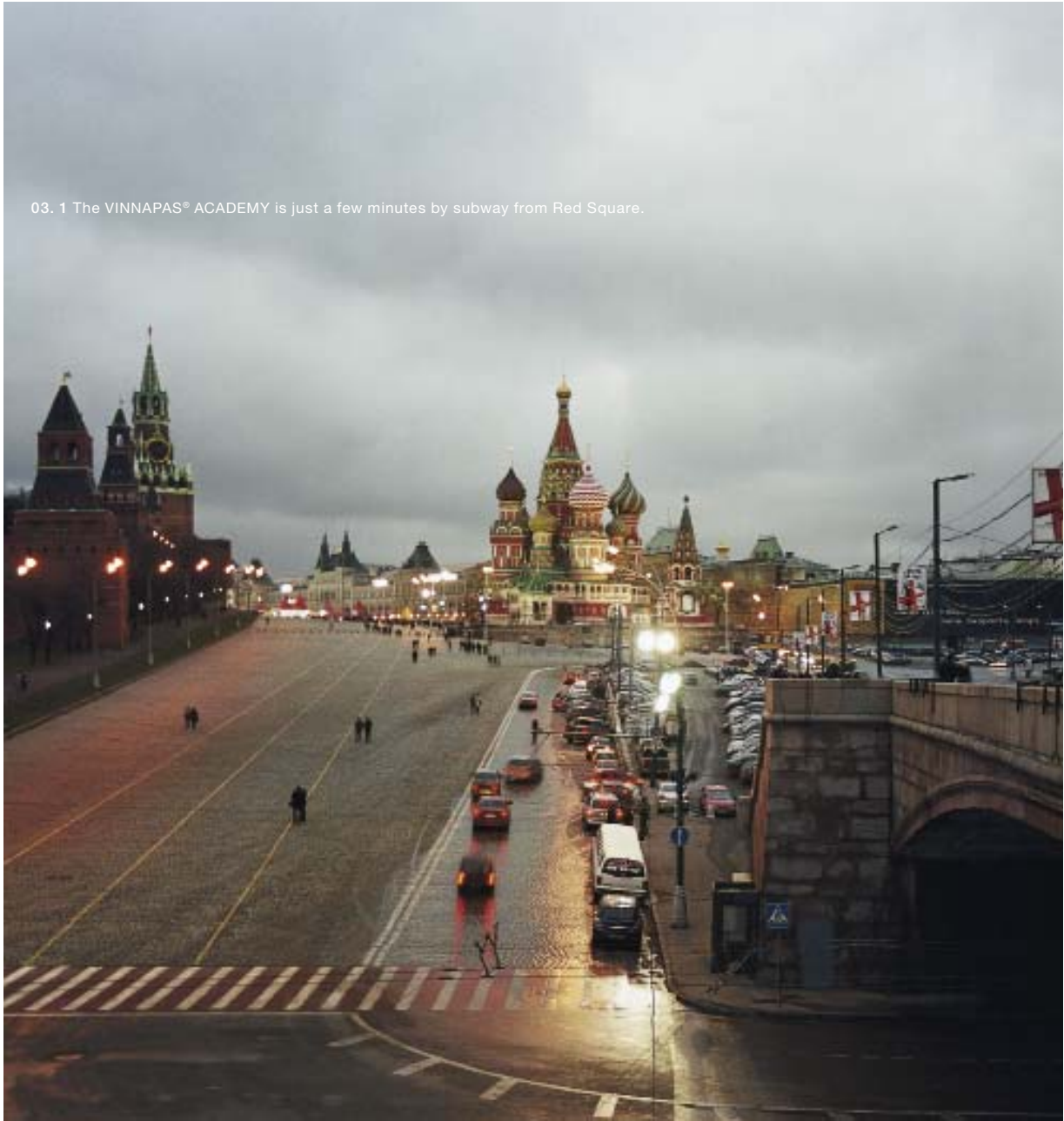

[Market] The market served by WACKER POLYMERS in Russia emerged just 20 years ago with the opening up of the then Soviet Union. Today it's about a quarter to a third the size of the German market, but is growing very fast – at a rate of about 10% per year. There is strong demand for exterior insulation and finish systems, with many buildings having gone up in the 1960s and 1970s with very poor insulation.



Mr. FirsaeV, what factors does a company need to consider if it wants to do business in Russia?

Russians like to conduct business face to face. This is the traditional way. Talking on the telephone tends to lead to complications. Building up a personal relationship is important. As a consequence – with the country and consequently our market being so large – our sales force is on the road pretty much the whole time. As well as Russia, our sales area takes in Belarus, Ukraine and Kazakhstan. Our main customer base is in the dry-mortar sector, which encompasses around 150 large companies that between them own about 200 factories.

What do Russian customers want?

A few years ago, many Russians felt that foreign goods and materials were better than their Russian equivalents. We imported everything. That's now changed. We have much more self-confidence and faith in our own products, to which huge improvements have been made. Foreign companies have grasped this fact and are now locating their factories here – not just in the dry-mortar sector, but also in the auto industry, for example.

Russia is a huge country. How big is the Russian market?

The market served by WACKER POLYMERS emerged just 20 years ago with the opening up of the then Soviet Union. Today, it's about a quarter to a third the size of the German market but is growing at a rate of about 15% per year. There is strong demand for exterior insulation and finish systems, with many buildings having gone up in the 1960s and 1970s with very poor insulation. Otherwise, the Russian market is becoming more like the German one. The quantity of high-quality products is constantly rising, but whereas in Germany the proportion of such products is around 80%, in Russia it's just 20%. I think in 10 to 15 years, though, we'll be at the same level.

[VINNAPAS® ACADEMY] The first VINNAPAS® ACADEMY was founded in Burghausen in 2006, initially with the aim of offering in-house training. One year later, the first customer seminar was scheduled and the VINNAPAS® ACADEMY in Beijing was opened. This was followed in 2008 by the Moscow academy. Further training centers are in the pipeline, including one in Dubai.



03. 3 Kazan Cathedral at the Northern end of Red Square.

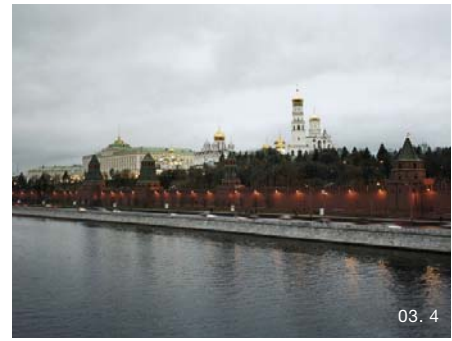

03. 4 The Kremlin from across the Moskva River.

How can the VINNAPAS® ACADEMY contribute to this growth?

We meet the growing demand for theoretical and practical knowledge of our products. In the technical center, we were only able to touch on the practical side. Conversations were generally one to one, which is not especially efficient. Now, we're able to standardize training sessions and hold them on our own premises. Having become more professional and more efficient, our training activities are starting to gain a reputation in themselves.

Why is having a VINNAPAS® ACADEMY in Moscow particularly important?

The initial idea for the academies arose in parallel with the idea for the technical centers, which WACKER planned around the turn of the millennium and implemented several years ago. Since then, the company has become increasingly globalized. As WACKER has become active in ever more markets, local needs and local conditions have become increasingly apparent. In Russia, for example, the climate is very difficult. We have a long winter, from November to March, and the products have to be adapted to this fact. We have two test walls and a climate chamber in Moscow, which enable us to simulate a broad range of climatic conditions, ranging from tropical humidity to extreme permafrost.

Apart from variations in climate, are there other regional differences in Russia?

Sure, there are very big differences. Moscow is relatively prosperous, and our customers in the Moscow area produce dry mortars with a large proportion of value-adding additives. In contrast, companies outside Moscow want much cheaper products, as the non-Moscow market doesn't offer the same returns. We still have to offer these customers high-quality products, however. Many smaller businesses – especially businesses outside Moscow – don't have a travel budget. With these companies, we prefer to hold seminars on site.

[Technical Centers] WACKER operates eleven technical centers in Adrian/Michigan, Allentown/Pennsylvania, Burghausen, Dubai, Melbourne, Moscow, Beijing, São Paulo, Shanghai, Singapore and Suwon. Equipped with state-of-the-art technology, the centers are home to WACKER specialists who, in conjunction with our customers, adapt products to local conditions.



Which, presumably, requires some coordination between the technical center and the academy?

Yes. The VINNAPAS® ACADEMY is linked to the technical center, and customers attending training sessions can use the facilities of both. This proximity is also important for facilitating communication. It allows us to get customers together with the relevant technical and training managers over dinner, say. Sharing information at a personal level consolidates the relationship with our customers and is a huge help in resolving everyday business problems.

Give an example – what exactly are customers interested in at the academy?

Since our customers are primarily from the dry-mortar sector, they're often interested in chemical additives for dry mortars. How do additives react with other components? How do they work? What quantities should be used and how should they be used? We offer seminars for the engineers who develop dry-mix mortars. One reason this is important is because Russian university courses have only started to deal with dry mortars in the last ten years. Prior to that, it was always exclusively about cement and concrete. We're also going to be holding seminars for our own sales staff and distributors who are involved in selling outside Russia, especially in Ukraine, where managers tend to ask a lot of in-depth questions that our sales staff can't answer.

What benefits does the academy offer WACKER?

Internally, all our staff worldwide can attain the same level of knowledge. Externally, it creates a new platform on which WACKER can get together with its customers without having to talk sales. WACKER also gains valuable additional input for product development. It allows us to reach out to new target groups – visitors to the technical center tend to be primarily technical staff, whereas at the academy we're able to play host to the entire company. Lastly, it also helps build contacts with strategic partners such as stand-

[Running to a Different Schedule] The extreme climate largely prevents customers in Russia from being able to continuously improve their products, explains Dmitriy Firsae. Construction companies have to complete their work in spring, summer and fall. It's only during the winter months, when very little outdoor work is carried out, that they have the time to devote to product innovation.



03. 6 – 7 Concentration in the new seminar rooms.

23

ards institutions, ministries and universities. The academy is supported by our supervisory board, whose members include professors from specialist construction and architecture universities in Moscow and St. Petersburg. They help us improve the quality of our program.

Are there any major challenges for which WACKER needs to be prepared?

With our very strong market presence, we have, in recent years, invested large sums in developing the dispersible powders market. This was necessary to establish WACKER as a market leader, but our competitors have also benefited, in that they are faced with a prepared market without having incurred the costs of preparing it. The VINNAPAS® ACADEMY allows us to offer something extra, in that we can support our customers with dispersible powders know-how to help them stand out from their competitors.

Mr. Firsaeu, what makes you a good training manager?

I learned a lot about customers when I worked in the technical center. I know exactly where the problems are and where customers need help and advice. Most of our customers want to know as much as possible. Maybe this is an especially Russian quality, something shared by the Germans, who also like to have everything explained very precisely.

Thank you for talking to us.

[Product] VINNAPAS® dispersible polymer powders are primarily based on vinyl acetate and ethylene. These thermoplastic, plasticizer-free polymers are added to tile adhesives and joint fillers, mineral plasters, exterior insulation and finish systems, sealing slurries, gypsum, repair mortars, self-leveling flooring compounds, and powder paints.



24 8:45 p.m. ...



04



Growing Where Demand Is Growing. The World's Largest Integrated Production Facility Is Being Constructed in the Growth Market of China.

If WACKER wants to be accepted in a major market as crucial as China, the company really needs to develop its own production capacities. WACKER's philosophy is that if you want to do business globally, you've got to put down roots in local markets. "We work to global environmental protection and occupational health and safety standards, but if we want to satisfy our customers, we have to be unequivocally local in our thinking," explains WACKER President and CEO Dr. Rudolf Staudigl.

That WACKER has beaten an unorthodox path to this goal is no surprise – it shows the breadth of possibilities offered by globalization. What has already proved a success in the semiconductor field with its Korean partner Samsung in Singapore is here being repeated with American rival Dow Corning. The two companies are jointly constructing an integrated chemical site in the world's most important growth market for silicones. When the Zhangjiagang plant reaches full capacity in late 2010, it will produce around 210,000 metric tons of siloxanes and pyrogenic silica annually.

[Sector] WACKER SILICONES supplies more than 3,000 silicone products and is a leading global producer of silanes and silicones. The division employs 3,927 staff worldwide. In 2008, WACKER SILICONES posted €1.40 billion in sales and an EBITDA of €167.9 million.



04. 1 Denny Klein and Dr. Udo Horns (right) enjoying an evening conversation in the park.

[Market] China is the second largest consumer of silicones in Asia. The market is growing rapidly, as disposable incomes increase over the next few years and ever more people are able to purchase higher quality goods, with a higher silicone content. WACKER expects annual demand for siloxanes in China to reach 0.5 million metric tons within a few years.

There is one sunny day in the fall of 2003 that Dr. Udo Horns remembers very well. He was standing in the midst of overgrown grass and peanut plants, dressed in a white shirt and dark tie, on a huge expanse of waste land in an industrial park in Zhangjiagang, China. A few hundred meters behind him, a dike held back the mighty kilometer-wide Yangtze River. Horns lifted a stick and pointed to the west. In his mind's eye, the 53-year-old could already see a new industrial facility rising up out of the earth. "We'll build the pipe bridges here, the warehouse and administrative center over there, the grinding plant and furnaces will go here. I could visualize the plant, like a man building a house, standing on his lot saying, 'We'll have the lounge here, we'll put the kitchen over there,'" recalls Horns, a chemist by training.

Today, Udo Horns' vision is reality. Horns, who has worked for WACKER for ten years, was responsible for making the joint venture with US company Dow Corning in Zhangjiagang happen. The result: the two companies were able to bring the first phase of the new pyrogenic silica and siloxane plant on line in November 2008. Total investment on the one million square meter site is US\$1.2 billion. With this investment, WACKER is showing its commitment to the key Chinese growth market not merely with sales and marketing, but with its own production facilities. In Horns' opinion, this is money well-invested, "If Chinese society continues to develop as rapidly as it is at present, it's not hard to imagine the scale of the opportunities China offers for our products." The rising per capita income in China means that increasing volumes of high-quality goods containing a higher quantity of silicones are being purchased. Horns does a quick back-of-an-envelope calculation; in the US, annual siloxane consumption for cosmetics, care products, auto construction or household goods is two kilograms, in Germany it is 1.2 kilograms – in China it is just ten grams.

Efficient Utilization. Although WACKER and Dow Corning are competitors both in China and elsewhere, they are working together on a unique project to produce raw materials for use in downstream processes within China. When it gets to the point of manufacturing products from these raw materials, the two companies go their separate ways. The primary

[Production] In Zhangjiagang, silicones, special silicones, and pyrogenic silica are manufactured in a series of stages from raw silicon, methyl chloride, and water. The process results in the production of hydrogen chloride, which is either reused in the initial process or reacted with silicon, alcohol, and finally with water.

04. 2 A Chinese worker taking a break.



04. 3 The new WACKER site in Zhangjiagang.



benefit for WACKER is that the sheer size of the plant reduces production and infrastructure costs. Dow Corning in turn benefits from WACKER's vast experience with the pyrogenic silica production process. Pyrogenic silica is produced from the waste from siloxane production. This results in a cycle which utilizes 90% of all by-products, which would otherwise require disposal.

Dinner as a Problem-Solving Tool. The entire project has been coordinated by a steering committee and various working groups. The groups, which met up to four times a year, drew up investment budgets and clarified questions relating to taxation and regulations. A particularly important issue in China, says Horns, is that "out here you need to have a special team to maintain contacts with the regulatory authorities and state officials." Taxes and land prices are negotiable, and customs duties and fire prevention regulations are also much discussed. It is common to get together to discuss such issues over food, which has great cultural significance in China, he explains. "I must have sat talking about the plant with different groups of people at two or three dinners a week."

[Unfamiliar Structures] Self-employment has a long tradition in China. Many Chinese people would like to run their own company or at least be head of a team. WACKER has responded to this by modifying the structure of the business in China to encompass a larger number of levels of hierarchy, explains Dr. Udo Horns. "To us, globality means diversification."



Horns is convinced that it is not enough to merely accept the laws and regulations of a country in which you wish to sell your products. Globalization only works where businesses build on the foundations of the culture and traditions of the country in which they are operating.

In Zhangjiagang, this has, he is convinced, been a great success. “We have created the best integrated production system I could possibly imagine,” he says, standing in the middle of the plant, at approximately the spot where, five years earlier, he found himself pointing in the direction of bushes and bare earth. Horns plans to return now and again in a few years time, once production is at full strength. “When you develop something like this, you can’t help but get attached to it; you want to know what happens to it down the line,” he says.

[Products] Siloxane is one of the raw materials for producing silicones, which are used in areas such as the construction, chemicals, cosmetics, textiles, auto, paper and electronics industries. Pyrogenic silica is used as a raw material for further chemical processes or in printing inks, adhesives, and polyester resins, as well as in the cosmetics, pharmaceuticals and food industries.

The world is growing ever smaller. In the future, our enterprise and our operations will become even more global. What will remain the same is that markets, customers and cultures will continue to differ. We will continue to do all we can to meet our customers' expectations, whatever corner of the world they call home. Through high-quality products, outstanding on-site service and our concept of the right way to carry out global collaboration – through partnership and with trust. A sound basis for going forward into the future.

Paths to Globality

CH1 ...// WACKER Stock

35

WACKER Stock

CH2 ...// Management Report ...// Business Environment

43

Business Environment

51

Corporate Decision-Making, Targets and Strategy

CH3 ...// Management Report ...// Business Development

59

Overview of Business Development

65

Profitability

68

Assets

71

Financial Position

76

Segments

82

Regions

83

Further Information

99

Risk Management Report

106

Supplementary Report

CH1

CH4 ...// Management Report ...// Opportunities and Outlook

109Opportunities
and Outlook

CH5 ...// Financial Statements

121Income
Statement

122

Balance Sheet

124Cash Flow
Statement

125Statement of
Comprehensive
Income

126Statement
of Changes
in Equity

127Reconciliation
of Other Equity
Items

128Segment
Information
by Division

130Segment
Information
by Region

131

Notes

192Supervisory
Board

194

Executive Board

195Report of the
Supervisory
Board

200Corporate
Governance

202Compensation
Report

205Declaration by
the Executive
Board

206Auditor's
Report

208

Glossary

211Index
A – Z

WACKER FINE CHEMICALS ...//



Active Cell Protection

...// Lycopene is considered a free-radical scavenger and strengthens the immune system's defenses more effectively than vitamin C. Contained in high concentrations in tomatoes, this natural cell protection is also available as a tablet supplement. To function effectively, however, the antioxidant needs protection. CAVAMAX® γ -cyclodextrins encapsulate the lycopene, thereby stabilizing its special properties. WACKER FINE CHEMICALS is the world's sole manufacturer of all three natural cyclodextrins – α , β and γ .

In 2008, WACKER stock was clearly not immune to the broad downtrend impacting stock exchanges. Following 2007's 100% gain, which made WACKER one of Germany's top capital-market performers, our share price fell last year. The decline was triggered by the international financial crisis, which spread to the real economy in the second half of 2008. Share prices, including WACKER's, visibly suffered from the impact. After averaging €142.42 in Q1, WACKER stock lost ground as the year progressed, finishing at €74.71 on December 31, 2008. The MDAX fell 43% and the DAX 40% over the same period.

Capital-Market Turbulence – WACKER's Share-Price Trend

Our Group's solid progress was not rewarded by capital markets due to the international financial crisis and the poor outlook for the chemical and semiconductor industries.

From a peak of €197.70 on January 1, 2008, WACKER's share price dropped to €114.81 in March 2008. The decline chiefly stemmed from two factors. First, market expectations for semiconductors were revised downward. Second, analysts curbed their upbeat forecasts for solar-sector companies. Soon, their opinions about continued solar growth turned negative as Germany and Spain (two key markets) lowered their feed-in payments for solar power. WACKER – a major manufacturer in both markets – was unable to fend off the pressure.

After publication of record 2007 figures on March 18, 2008, WACKER stock recovered slightly, peaking in May at almost €170. June's Capital Markets Day in London also fueled the share price, before a firm downtrend ensued in August.

With mid-September's bankruptcy of the Lehman Brothers investment bank, the financial crisis took a dramatic turn for the worse. In Q4 2008, it hit the real economy, as many market analysts had predicted. Several of WACKER's markets were affected, including semiconductors, construction and the automotive sector. As for the solar market, it was impacted by profit warnings from numerous Chinese companies and dim forecasts from German solar-module makers.

In our Q4 conference call, we reconfirmed our forecast for 2008. WACKER's share price, however, only made a brief recovery. It closed the year at €74.71 after two highly volatile months in November and December.

In all, WACKER stock lost 62 % of its value during 2008. Its high for the year was €197.70 and low €62.23.

Facts & Figures for Wacker Chemie AG's Stock

High for the year (on January 1, 2008)	€	197.70
Low for the year (on October 27, 2008)	€	62.23
Starting price	€	197.70
Year-end closing price	€	74.71
Performance for the year (without dividend)	%	-62
Year-end market capitalization (shares outstanding; 2007: 9.8)	€ billion	3.7
Average daily trading volume (2007: 29.6)	€ million	28.4
Earnings per share	€	8.84
Dividend per share (proposal)	€	1.80
Dividend yield	%	1.5

All share-related data based on XETRA trading.

Earnings per Share of €8.84

Earnings per share (EPS) is calculated by dividing net income allocable to Wacker Chemie AG shareholders by the weighted average of all shares in circulation during the year. In 2008, the number of shares in circulation was 49,677,983. On this basis, the EPS is €8.84.

Earnings Per Share
Rises to €8.84

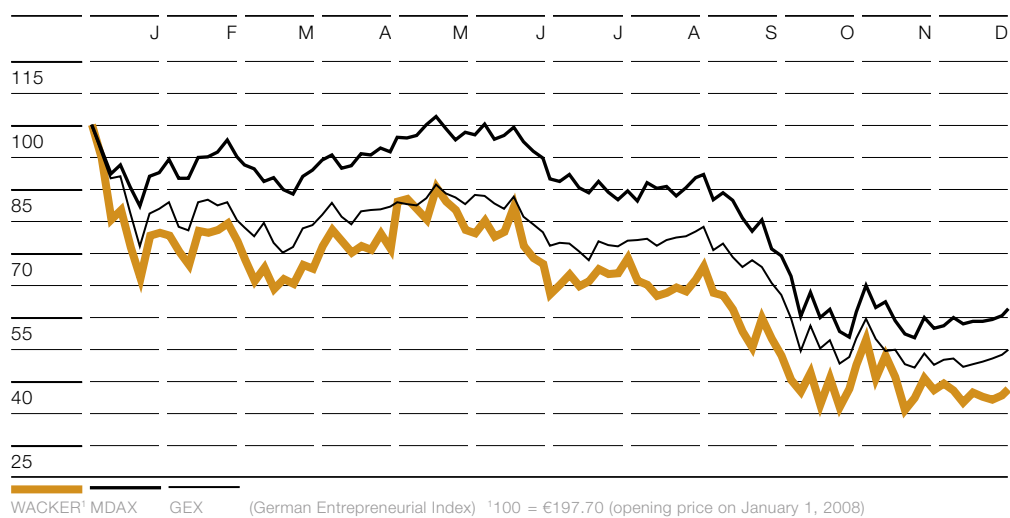
WACKER Share Performance (Indexed to 100)¹**Facts & Figures on WACKER Stock**

ISIN	DE000WCH8881
Ticker, security identification number (WKN)	WCH888
Frankfurt Stock Exchange	WCH
Bloomberg	CHM/WCK.GR
Reuters	CHE/WCHG.DE
Capital stock	€260,763,000
Number of shares (as of December 31, 2008)	52,152,600

Dividend Payment of €3.00 per Share

At the Annual Shareholders' Meeting of May 8, 2008, it was decided to pay shareholders a €2.25 dividend per share and €0.75 special bonus from 2007's profits. The dividends and special bonuses were distributed to shareholders on May 9, 2008. WACKER paid a total dividend sum of €149.1 million (€124.2 million paid out in 2007 for 2006). At a volume-weighted average share price of €151.64 in 2007, this produced a dividend yield of 2.0%. Based on the net Group income allocable to Wacker Chemie AG shareholders, the dividend yield was 35%.

Increase in Analysts' Coverage

Last year, the average daily trading volume for WACKER stock was some 230,000 shares (XETRA) – a marked increase against the 2007 figure of around 200,000 shares (XETRA). The number of analysts regularly monitoring and assessing the company grew significantly. At the beginning of 2008, 23 analysts covered WACKER. By the end of the year, there were 29. During the fiscal year, the analysts consensus price target fell substantially, reflecting the general trend. Whereas the average Q1 estimate had WACKER's share price at €160.62 (11 estimates)¹, the fair-value price target was down to €118.71 (19 estimates)¹ by year-end.

The following banks and investment firms monitor and assess WACKER:

B. Metzler seel. Sohn & Co.	HSBC Trinkaus
Bankhaus Lampe	JP Morgan
Bayerische Landesbank	Kepler Capital Markets
BHF-Bank	Landesbank Baden-Württemberg
CA Cheuvreux	MainFirst Bank
Citigroup	M.M. Warburg & Co
Commerzbank	Merrill Lynch
Credit Suisse	Morgan Stanley
Deutsche Bank	Norddeutsche Landesbank Girozentrale
Dresdner Kleinwort	Soleil Securities
DZ Bank	Sal. Oppenheim
equinet	UBS
Exane BNP Paribas	UniCredit
fairesearch GmbH & Co.	WestLB
Friedman, Billings, Ramsey & Co	

¹Consensus figures: VARA

On our website, we regularly report on the consensus of analysts' expectations for the current year. Moreover, our website offers extensive information on WACKER stock. In addition to financial reports, presentations and publications (viewable online or downloadable), you'll find all our key financial-market data, as well as contact information. You can also view videos of our annual press conference, analysts' conference and other events or listen to an audio stream. With the publication of our 2008 Annual Report, we have enhanced the service offered to analysts and investors. Our new easy-to-navigate online version of the report facilitates information access. Interactive options – such as key-indicator comparisons and a toolbox – enable readers to work with the figures. → www.wacker.com

Our New Online
Annual Report
Improves the
Service We Offer
to Shareholders

Sharp Drop in Market Capitalization and MDAX/GEX Weightings (as per December 30, 2008)

The performance of WACKER stock reduced its market capitalization to €3.7 billion by year-end (total stock without treasury shares). WACKER's MDAX market capitalization is €1.30 billion and determined exclusively according to the free float, including treasury shares. Thus, WACKER had an MDAX weighting of 3.04% and ranked seventh among the 50 companies listed there. WACKER's GEX weighting was 9.66%. Deutsche Börse's GEX midcap index (introduced in January 2005) comprises owner-dominated companies listed on the Frankfurt Stock Exchange (Prime Standard) for no more than ten years. In 2008, WACKER ranked third in that index, after heading it a year earlier.

Investor Relations Work Enhanced

Our company's strategic focus on growth and sustainably high margins is reinforced by continual and open communications with institutional/private investors and analysts. In 2008, we increasingly approached national and international investors and analysts to explain our business strategy, key financial indicators and future outlook. On many occasions, Executive Board members attended in person to answer questions from capital-market participants. Our event calendar included 22 roadshows in Germany, other European countries and the USA. We also held about 220 one-on-one meetings and participated in various international conferences. WACKER gave presentations at, for example, the HSBC Small/Mid Cap SRI Conference in Frankfurt, the Kepler Alternative Energy Conference in Paris, Deutsche Bank: German and Austrian Corporate Conference in Frankfurt, the EPIA PV Conference in Valencia, Credit Suisse Technology Day in Frankfurt and the Merrill Lynch European Chemicals Conference in London.

In 2008, we held our second WACKER Capital Market Day in London. The event was a success. Over 50 analysts and investors took part, either in person or – for the first time – via a webcast. They were able to gain an up-to-date overview of our company, technologies, innovations, and much more. This event was the first time that Dr. Rudolf Staudigl met analysts and investors in his new role as president and CEO.

In 2008, Wacker Chemie AG also engaged in ongoing dialog with private investors, presenting the Group and its markets at various forums. For example, we attended the Hamburg Exchange Convention, the shareholder forums organized by the DSW (German association of small investors) in Munich and Frankfurt, and the corporate presentations held by the SdK shareholder association in cooperation with Karlsruhe's Sparkasse savings bank.

Shareholder Numbers Grow Strongly in Europe – 20% Decline in the USA

An analysis of our shareholder structure in Q3 showed that the number of US-based shareholders had dropped sharply. Whereas some 60% of our shares had been owned by Americans in September 2007, the figure fell to just over 40% a year later. The decline was chiefly due to the subprime crisis in the USA and the ensuing global financial crisis. In contrast, the number of Swiss shareholders rose to 14% (2007: 3%).

Wacker Chemie AG's largest shareholder is still Dr. Alexander Wacker Familiengesellschaft mbH, Munich. It holds over 50% of the voting shares in Wacker Chemie AG (2007: over 50%).

In 2008, Blue Elephant Holding GmbH (Pöcking, Germany) once again did not have any voting-share changes to report, which means it still holds over 10% (2007: over 10%) of Wacker Chemie AG.

Artisan Partners Limited Partnership, Milwaukee (Wisconsin, USA) owns over 5% of the voting shares in Wacker Chemie AG (2007: over 5%).

CH2 ...// Management Report ...// Business Environment

In 2008, WACKER forged ahead, building on its prior-year successes, with new sales and earnings records. You'll find detailed information in our Management Report.

43

Business
Environment

51

Corporate
Decision-Making,
Targets and
Strategy

CH2

WACKER POLYSILICON ...//



Hyperpure Silicon for a Sunny Outlook

...// Polycrystalline silicon solar cells directly transform sunlight into electricity. This is how photovoltaics convert the sun's natural energy into an environmentally-compatible and economical power source. Solar modules do not require fossil fuels for operation, nor do they produce emissions. WACKER POLYSILICON is one of the world's leading suppliers of hyperpure polycrystalline silicon – a vital starting material for challenging solar and photovoltaic applications.

Group Structure and Operations

WACKER is a globally active company with over 3,500 products serving more than 3,500 customers in over 100 countries. Our portfolio includes highly-developed specialty chemicals. Found in countless everyday items and ranging from hairsprays to solar cells, these products are used, for example, as starting materials for non-naturally occurring actives. They also permit new production processes or make existing ones more environmentally sound and cost-effective. Moreover WACKER products are often additives that, even in trace amounts, impart novel or improved properties to well-known materials.

Most of these products are based on inorganic starting materials. Silicon-based and ethylene-related products comprise 80% and 20%, respectively, of WACKER sales. Our customers include the consumer goods, food, pharmaceutical, textile, solar, electrical/electronic and basic chemical material sectors, as well as medical technology, biotech and mechanical engineering. As a producer of silicones and polymers, WACKER is particularly well represented in the automotive and construction sectors. Moreover, we are a key supplier of silicon wafers to the semiconductor industry.

At WACKER, global is normal. Many WACKER customers have a worldwide footing. We ensure customer proximity by operating on all five continents and consistently expanding our presence in growth regions. Our network of over 100 subsidiaries and sales offices is tailored to our customers' needs and logistics. This dense network is enhanced by our 17 technical centers across the globe. In fiscal 2008, WACKER opened a further center in Moscow.

Our production structure is just as globally oriented as our sales and service network. With a total of 27 production sites in Europe (9), the Americas (9) and Asia (9), we have a presence in all key regions.

WACKER Products
Contribute to
the Quality of Life

The WACKER
Group Is at Home
Worldwide
and Close to its
Customers

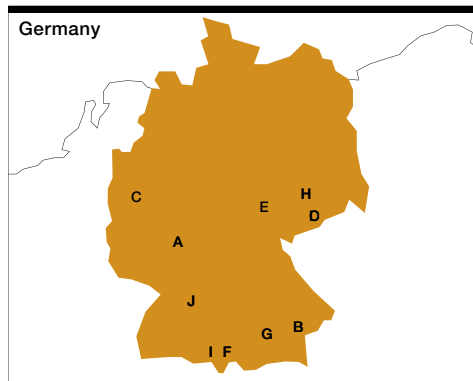
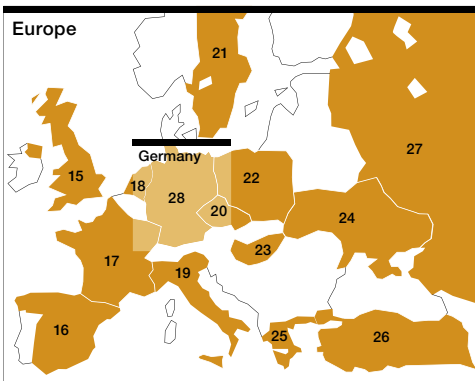
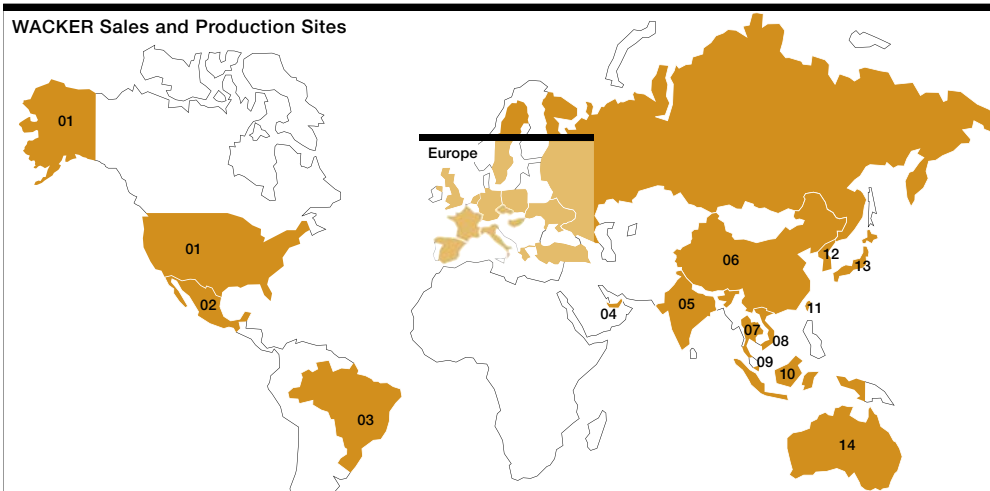

The Americas

- 01 USA**
Adrian /Michigan
Allentown/Pennsylvania
Austin/Texas
Calvert City/Kentucky
Chino/California
Duncan/South Carolina
Eddyville/Iowa
North Canton/Ohio
Portland/Oregon
San José/California
South Brunswick /
New Jersey
- 02 Mexico**
Mexico City
- 03 Brazil**
Jandira/São Paulo

Asia/Australia

- 04 United Arab Emirates**
Dubai
- 05 India**
Bangalore
Kolkata
Mumbai
New Delhi
- 06 China**
Beijing
Guangzhou
Hong Kong
Nanjing
Shanghai
Shunde
Wuxi
Zhangjiagang
- 07 Thailand**
Bangkok
- 08 Vietnam**
Ho Chi Minh City

- 09 Singapore**
Singapore
- 10 Indonesia**
Jakarta
- 11 Taiwan**
Hsinchu
Taipeh
- 12 South Korea**
Seoul
Ulsan
- 13 Japan**
Akeno
Hikari
Osaka
Tokyo
- 14 Australia**
Melbourne

Europe

- 15 Great Britain**
Chertsey
- 16 Spain**
Barcelona
- 17 France**
Lyon
- 18 Netherlands**
Krommenie
- 19 Italy**
Milan
- 20 Czech Republic**
Plzeň
Prague
- 21 Sweden**
Solna
- 22 Poland**
Warsaw
- 23 Hungary**
Budapest
- 24 Ukraine**
Kiev
- 25 Greece**
Athens
- 26 Turkey**
Istanbul
- 27 Russia**
Moscow
- 28 Germany**
A Alzenau
B Burghausen
C Cologne
D Freiberg/Saxony
E Jena
F Kempten
G Munich
H Nünchritz
I Stetten
J Stuttgart

WACKER has five business divisions offering a broad range of innovative and highly-developed products and services. The WACKER Group has a matrix organization with clearly defined business responsibilities. The five divisions have global responsibility for their own products, production facilities, markets, customers and business results. Regional organizations are responsible for all business in their region or country. Aside from its divisions, the Group has corporate departments that primarily provide groupwide services, though some are also involved in production-related functions.

Wacker Chemie AG's Structure

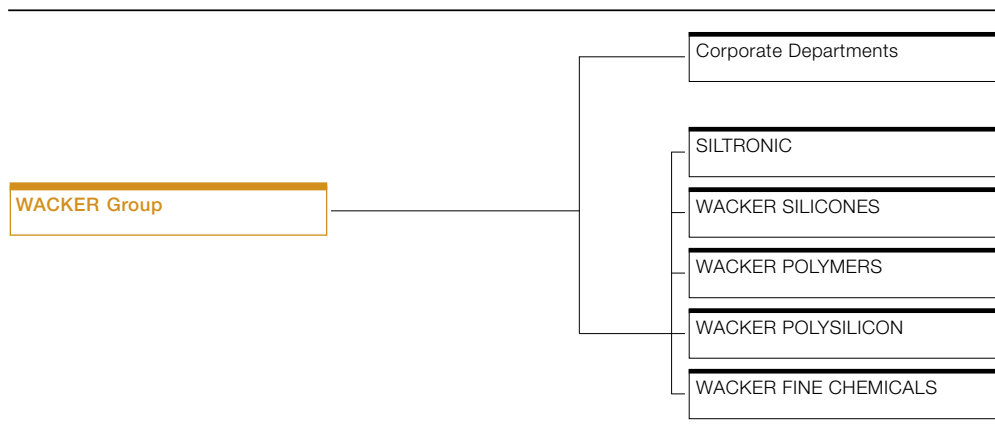

Management and Supervision

In compliance with the German Stock Corporation Act (AktG), Wacker Chemie AG has a dual management system, comprising the Executive Board – in charge of running the company – and the Supervisory Board – which oversees the Executive Board. Wacker Chemie AG's Executive Board consists of four members. Assisted by WACKER's corporate departments, the Executive Board coordinates strategies, resources, and the Group's infrastructure and organization. Wacker Chemie AG is the parent company, responsible for corporate strategy and overall management, resource allocation, funding, and communicating with WACKER's major target groups, especially the capital market and shareholders.

A new CEO took charge in 2008. Former CEO Dr. Peter-Alexander Wacker left WACKER's Executive Board on May 8, 2008. Following the annual shareholder meeting that same day, the reconstituted Supervisory Board appointed him as the company's new Supervisory Board chairman. His successor as CEO is Dr. Rudolf Staudigl, who has been a member of WACKER's Executive Board since 1995. Likewise effective May 8, 2008, Dr. Wilhelm Sittenthaler joined WACKER's Executive Board. Dr. Joachim Rauhut and Auguste Willems remain as the other two Executive Board members. The Executive Board's new composition made it necessary to reallocate the responsibilities of individual board members.

Leadership
Changes at the
Executive and
Supervisory
Boards

Executive Board Responsibilities

	from May 8, 2008	until May 8, 2008
Dr. Rudolf Staudigl	President & CEO WACKER SILICONES Executive Personnel, Corporate Development, Corporate Communications, Investor Relations, Corporate Auditing, Legal & Insurance, Corporate R&D, Intellectual Property	WACKER SILICONES Human Resources (Personnel Director), Site Management, Environment, Chemicals, Safety, Corporate R&D, Intellectual Property Region: Asia
Dr. Joachim Rauhut	WACKER POLYSILICON Corporate Accounting, Corporate Controlling, Corporate Finance, Information Technology, Raw Materials Procurement, Technical Procurement & Logistics, Tax Regions: Europe, NAFTA	Corporate Accounting, Corporate Controlling, Corporate Finance, Information Technology, Tax, Procurement and Logistics Region: Europe
Auguste Willems	WACKER POLYMERS WACKER FINE CHEMICALS Corporate Engineering, Sales & Distribution, Site Management, Corporate Security Regions: Middle East, India, South America	WACKER POLYMERS WACKER FINE CHEMICALS Corporate Engineering, Sales & Distribution Region: The Americas
Dr. Wilhelm Sittenthaler	SILTRONIC Human Resources (Personnel Director) Region: Asia/Pacific	
Dr. Peter-Alexander Wacker		President & CEO SILTRONIC WACKER POLYSILICON Executive Personnel, Corporate Development, Corporate Communications, Corporate Auditing, Legal Affairs, Investor Relations

Dr. Peter-Alexander Wacker is Wacker Chemie AG's new Supervisory Board chairman. He succeeds Dr. Karl Heinz Weiss, who was a Supervisory Board member for 37 years. WACKER's Supervisory Board comprises 16 members, of whom eight are employee representatives. → See further details on Wacker Chemie AG's governing bodies, Group management and supervisory structures on page 192, as well as the Compensation Report on page 202.

Legal Structure of the WACKER Group

In November 2005, WACKER became a stock corporation (AG) under German law headquartered in Munich. Wacker Chemie AG holds a direct or indirect stake in 64 companies belonging to the WACKER Group. The consolidated financial statements cover 57 fully consolidated companies. A further seven companies accounted for using the equity method are included.

Accounting

WACKER prepares its consolidated financial statements in accordance with International Financial Reporting Standards (IFRS) valid on the reporting date, and interpretations of the International Financial Reporting Interpretations Committee (IFRIC), as used in the European Union, as well as with supplementary rulings of Section 315a, Subsection 1 of the German Commercial Code (HGB). → See further details on page 140

Key Products, Services and Business Processes

WACKER's Siltronic division produces silicon wafers for leading semiconductor manufacturers. These wafers form the fundamental basis for virtually all semiconductor products. Silicon wafers are used to make discrete semiconductor components (e.g. transistors and rectifiers) and microchips (e.g. microprocessors and memory chips).

The WACKER SILICONES division offers customers our broadest product range with over 3,000 products. These span from silicone-based fluids, emulsions, resins, elastomers, sealants and silanes through to pyrogenic silica. We manufacture specialty products individually tailored to meet customers' needs, as well as standard products primarily used as starting materials in the production of silicones.

The WACKER POLYMERS division focuses on manufacturing state-of-the-art binders and polymer additives such as dispersible polymer powders and dispersions. These are used in diverse industrial applications or as base chemicals in the automotive, construction-chemical, paper and adhesive sectors, as well as in the production of coatings and printing inks. The construction industry is the main customer for polymer binders – used as an additive in tile adhesives, exterior insulation and finish systems (EIFS), dry-mix mortars and self-leveling flooring compounds.

For over 50 years, the WACKER POLYSILICON division has been producing hyperpure polysilicon for the semiconductor and electronics industries at its site in Burghausen, Germany. In recent years, it has increasingly supplied the solar industry, too. High demand for its polysilicon has helped make WACKER POLYSILICON the Group's fastest-growing division. Much of this polysilicon is sent to external customers. Internally, we supply Siltronic with polysilicon to make semiconductor wafers. Other internal customers are our joint ventures – WACKER SCHOTT Solar and Siltronic Samsung Wafer.

The WACKER FINE CHEMICALS division supplies customized biotech and catalog products. These include pharmaceutical proteins, cyclodextrins and cysteine, as well as organic intermediates and acetylacetone. This division focuses on customer-specific solutions for growth areas including pharmaceutical actives, cosmetics and food additives.

Major Markets and Competitive Positions

All five divisions generate the majority of their sales in markets where WACKER ranks among the world's top three suppliers. And we are the global market leader in some products. WACKER's key sales regions are currently Europe, the Americas and Asia. Over the past years, we have massively expanded our presence in Asia – particularly in China.

WACKER's Competitive Position

	Number 1	Number 2	Number 3
SILTRONIC	Shin-Etsu	Sumco	SILTRONIC
WACKER SILICONES	Dow Corning	Momentive	WACKER
WACKER POLYMERS	WACKER	Elotex (polymer powders)/ Celanese (dispersions)	Dairen (polymer powders)/ Dairen (dispersions)
WACKER POLYSILICON	Hemlock	WACKER	REC Solar

What Market Positions Do WACKER's Individual Divisions Command?

Siltronic is the third-largest global manufacturer of silicon wafers and other products for the semiconductor industry. Its customers include all major semiconductor companies worldwide, who account for over 80% of this division's sales.

In the silicones market, WACKER SILICONES is also Number 3 – plus, it is the global market leader in silicones for masonry protection. WACKER enjoys a leading position in Europe, where over half of our silicones sales were generated in fiscal 2008. Silicone products are used in a large number of industries. The market is therefore characterized by great product diversity and has experienced steadily rising demand over the past years. As is the case with WACKER's other divisions, WACKER SILICONES fastest-growing market is Asia. Today, Asia is already the most important market for silicone products. To match our success in other markets, WACKER is investing heavily in Asian market expansion – with a particular focus on China.

Leading Positions
in Attractive
Markets

With WACKER's acquisition of all shares in our two former partner companies with American-based Air Products, WACKER POLYMERS is now the world's largest producer of dispersions and dispersible polymer powders on a vinyl acetate/ethylene basis. Since fiscal 2008, we have been the only company in that market to offer a complete supply chain for dispersions and powders in Europe, the Americas and Asia. WACKER mainly supplies these products to the construction and textile sectors, as well as to producers of adhesives, paints and surface coatings. The largest growth potential lies in Asia – especially China.

In the year under review, WACKER POLYSILICON strengthened its position as the world's second-largest manufacturer of hyperpure polycrystalline silicon for electronic and solar applications. Production output rose by 3,800 metric tons to 11,900 metric tons in 2008. Growing demand for polysilicon is primarily driven by the solar industry. Naturally, the semiconductor sector has remained another important customer.

WACKER FINE CHEMICALS manufactures fine chemicals and pharmaceutical proteins, giving it a diversified customer portfolio. WACKER is the global leader in certain fine chemicals such as cyclodextrins and bio-engineered cysteine. We enjoy a promising market position in the production of pharmaceutical proteins, too.

WACKER's competitive edge is not restricted to the product front. Thanks to our integrated production system, we also preside over key manufacturing advantages, which cut costs via the recycling of process-related by-products and co-products in other process stages.

WACKER's R&D focus and innovative strength have resulted in cutting-edge products in numerous areas. Many of these offer customers significant advantages.

WACKER boasts a high degree of technological expertise. It is also characterized by high manufacturing productivity, close collaboration with customers when they develop new products, and major investments in high-volume production facilities. New competitors are thus confronted with high market-entry barriers. As a result, WACKER usually faces few competitors in virtually all its business fields.

Legislative and Economic Factors

WACKER, like most companies, is affected by general economic trends. Due to our product portfolio, we are able to cushion the cyclical movements of individual sectors to an extent. Our customer structure is so diverse that WACKER is not dependent on any one major customer. In fiscal 2008, attention firmly focused on euro exchange rates and further movements of raw material and energy prices. We attempt to dampen negative exchange-rate effects via hedging and expansion of our supply chain outside the eurozone. Rising raw material and energy costs prompted us to raise prices for many of our products in the year under review. Raw-material costs and the euro rose yet again during the first half of 2008, impacting sales and earnings.

The EU-wide REACH legislation came into force in June 2007. It governs the registration, evaluation, authorization and restriction of chemicals within member states. REACH imposes new regulations on manufacturers, importers and users of chemical products. Over the next few years, all substances on the European market must be registered and classified according to their properties if annual quantities exceed one metric ton.

WACKER Is
Well-Prepared
for REACH –
the New EU
Chemical Policy

In accordance with REACH deadlines, phase-in substances were preregistered in the second half of 2008. This chiefly included substances already listed in the European Inventory of Existing Commercial Chemical Substances (EINECS) and substances that had been manufactured at least once in the last 15 years before REACH came into force, but had never been placed on the market. We preregistered over 6,000 substances with the European Chemicals Agency (ECHA) and therefore met the deadline for completing the first step of REACH implementation.

WACKER also submitted the first batch of registration dossiers. This part of REACH will occupy us for the next ten years right up to the extended registration deadline. Even after this deadline, REACH will require us to register new substances.

In late 2008, moreover, the European Regulation on Classification, Labeling and Packaging of Substances and Mixtures (CLP) was published. The EU Commission's aim is to introduce the UN's new Globally Harmonized System of Classification and Labeling of Chemicals (GHS) to Europe. → See further details on page 97

The general legislative framework for Wacker Chemie AG did not change substantially in 2008. As a result, no additional conditions were imposed on our business operations.

WACKER's business policies focus on sustainably increasing the company's value in the long term.

Performance Indicators

The Executive Board charts the company's course on the basis of various financial parameters. Under the "EAGLE" acronym (Eye At Growing a Longterm Enterprise), WACKER has been consolidating value-based management groupwide since 2002. We view value-based management as an integral part of strategic planning. For this reason, the strategic positioning of a business entity and its contribution to boosting the company's value must be coordinated. This coordination is done as part of annual planning and comprises fundamental decisions on investments, innovation plans, new markets and a variety of other projects.

At WACKER, key performance indicators in assessing the corporate value trend are BVC (Business Value Contribution), EBITDA (Earnings Before Interest, Taxes, Depreciation and Amortization), cash flow and ROCE (Return on Capital Employed). The cost of capital employed is calculated as a weighted cost average of equity and debt. The various business segments are evaluated differently, depending on their specific risks. The company's ROCE shows us whether we have employed our capital successfully. CE (Capital Employed) is set in relation to EBIT. If CE generates a higher interest return than the cost of capital employed, that means WACKER has a positive BVC. BVC is a company-specific financial indicator, in which EBIT (adjusted for special factors) is set in relation to CE.

ROCE rose from 25.3 in 2007 to 25.7 in 2008. The minimum target of 14%, corresponding to the cost of capital, has thus been clearly exceeded.

WACKER Prioritizes
Value-Oriented
Management

Cost of Capital

	2008	2007
Riskless interest rate	5.0 %	4.0 %
Market premium	3.0 %	4.0 %
Beta coefficient	1.5	1.2
Post-tax cost of equity	9.5 %	8.8 %
Tax rate	35.0 %	37.0 %
Pre-tax cost of equity	14.6 %	14.0 %
Pre-tax borrowing costs	5.0 %	5.0 %
Tax shield (35 and 37 %, respectively)	1.7 %	1.8 %
Borrowing costs after taxes	3.3 %	3.2 %
Share of equity capital	90.0 %	80.0 %
Share of borrowed capital	10.0 %	20.0 %
Post-tax cost of capital	8.9 %	7.7 %
Pre-tax cost of capital	13.7 %	12.2 %

Strategic planning shows how value-related and corporate goals can be met. It is divided into two steps. First, divisions identify their market and competitive positions, as well as their value-related strength. The results are integrated into a proposal for each division's strategic positioning and planned measures. This information – which includes innovation and investment plans – is then consolidated on a Group level. The strategy-planning stage ends with a strategy conference, where plans are passed on the basis of their underlying target values.

Strategic planning decisions are then included in operational planning, which takes place in the second half of the year. The Executive and Supervisory Boards jointly approve the annual plan. We check on our success level via monthly reporting, which compares planned and actual figures. The reporting system also forms the basis for our monthly rolling forecasts. Our four-year medium-term planning provides a general framework for operational planning.

Financial Strategy

At WACKER, corporate financing is a core responsibility. In terms of capital requirements and cover, the need to balance conflicting demands such as profitability, liquidity, security and independence is at the heart of WACKER's financial strategy. The assets employed must yield a competitive return over long periods and earn their cost of capital. WACKER strives to finance corporate growth without outside help to the greatest possible extent. Sustaining a positive net cash flow is as important as generating a positive contribution to earnings. → See further details starting on page 71

The company's solvency is ensured by liquidity planning and adequate credit lines guaranteed in writing. WACKER's cash and cash equivalents and financing are constantly analyzed and adjusted on a rolling basis and according to multi-year plans. Generally, financing requirements are calculated and funding granted on a groupwide basis. Project-specific or regional funding is available, too, in special cases.

WACKER's financial strategy requires the setting aside of sufficient cash and cash equivalents, as well as credit lines. Most of our funding comes in the form of €805 million in unused credit lines (as per December 31, 2008) that can mainly be tapped as syndicated loans with multi-currency/multi-user facilities. Further examples include bilateral, special-institution and subsidiaries' local-working-capital credit lines. WACKER finances itself externally through private and public financial institutions (such as banks and special institutions) and publicly-traded, global money and capital markets. Currently, no other financial instruments, such as issuing corporate bonds, are in use. We aim to maintain our corporate financial structures such that our credit rating remains – at a minimum – in the upper investment grade range.

WACKER Has
Sufficient Liquidity
and Credit Lines

WACKER's business dealings with banks are based on long-term partnerships. The company collaborates with a number of banks (core-bank principle) to ensure optimum advice on all financial topics. To avoid cluster risks, a bank's stake in the credit lines promised to WACKER must not exceed 20%. Preferred banking partners are centrally-organized institutions with an impeccable credit rating.

Operational Control Instruments

WACKER controls its operational processes using an integrated management system (IMS). The company's IMS regulates our workflows and responsibilities, taking account of productivity, quality and environment, health & safety. It is based on legal provisions, as well as national and international standards. WACKER's voluntary commitments regarding the Responsible Care® and Global Compact initiatives go beyond what is set as a minimum by legislation and management standards. The main aspects of WACKER's IMS comprise several management systems certified to ISO 9001 (quality), ISO 14001 (environmental protection) and, in some instances, to OHRIS/OHSAS (occupational health & safety and plant safety), ISO/TS 16949 (quality) and HACCP (food hygiene).

An Integrated
Management
System Controls
Operational
Processes

All our processes are designed to give customers complete satisfaction, fulfill our social responsibilities, and ensure WACKER's competitiveness via sustainable and efficient business practices. Each of our sites achieves these goals in different ways. For example, Siltronic Portland's very effective "Quality and Value Improvement System" uses various control mechanisms such as balanced scorecards and instruments for developing, prioritizing and tracking action plans. Employed at all our business divisions as an overarching program, the "Wacker Operating System" (WOS) helps continuously improve plant and process productivity.

Growth Strategy

WACKER has set its sights on a clear goal – to maintain profitable growth.

How Do We Intend to Achieve this Goal?

WACKER concentrates on products and regions with above-average growth. Top priority is given to expanding our presence in dynamic regions and gaining new customers. WACKER wants most of its growth to be organic. However, we do look into the possibility of acquisitions that offer us opportunities for further commercial success. We make sure that any potential acquisition will support WACKER's long-term strategy.

This strategy is based on the Group's existing technological and entrepreneurial strengths. Our advanced products directly add value for our customers. We consider it important that most of our business fields command leading competitive positions. Our aim is to ensure that WACKER products and services are the preferred choice of customers in many areas of application.

WACKER's products are ideally served by key megatrends. These concern energy, urbanization/construction, digitization, and increased prosperity in newly industrialized countries.

We profit from the energy megatrend in a variety of ways. A key producer of solar-grade polysilicon, WACKER also manufactures numerous thermal-insulation and energy-conservation products. We are convinced that energy will become even more important in the years to come. Falling costs for photovoltaic systems in particular are making solar power increasingly competitive with conventional energy sources. Based on our own estimates, we expect many regions to be able to generate solar power more cheaply than traditional fuels by the next decade. This should finally help solar energy achieve its market breakthrough and become available in higher quantities.

Sustained construction activity (especially in Asia), advancing urbanization and infra-structural expansion all positively impact the demand for construction-sector polymers and silicones.

WACKER's
Strategy Aims for
Profitable Growth

The world is becoming ever more digital. WACKER uses the digitization megatrend by manufacturing silicon wafers for the semiconductor industry. Increasing product digitization and ever greater silicon demand in the consumer-electronics sector are driving volume growth. Additionally, this development is being fueled by Asian growth that would be impossible without digitization and infrastructural expansion.

The growing prosperity of newly industrialized countries boosts demand for our products – particularly in sectors such as electronics, consumer goods, cosmetics, pharmaceuticals, textiles and medical technology. Rising incomes in these countries enable the consumption of higher-quality products, which benefits WACKER.

Divisional Strategies

Siltronic AG (a wholly-owned WACKER subsidiary) places strategic importance on remaining a technology leader. This is why we continue investing in product developments and quality-boosting measures that uphold the division's high standards. Siltronic's wafer production focuses on the 300 mm segment, where it is in a strong position, thanks to its new Singapore-based 300 mm wafer fab – a Siltronic/Samsung joint venture – and expansion of 300 mm production in Germany. Another strategic aim at Siltronic is to continue reducing and adjusting fixed costs so as to respond even more effectively to semiconductor-sector demand fluctuations.

Thanks to diverse application prospects, we see further growth opportunities for WACKER SILICONES. Silicon chemistry is still relatively recent and has huge development potential. There is still plenty of scope for incorporating fascinating property profiles into our end products. Moreover, considerable development potential lies in combining silicon and carbon chemistries, whose properties can form a perfect complement. A strategy focus is to further bolster the division's position as a solution provider – not just by marketing products and materials, but also tailoring those product solutions to each customer's needs. A further strategic aim is to expand WACKER's integrated production system in key markets. The Zhangjiagang production site in China – our most promising market – is expected to be fully commissioned in 2010.

Having successfully acquired Air Products Polymers' business in 2008, WACKER POLYMERS met a major strategic goal. In fiscal 2009, we will be the only company to offer a complete supply chain in the dispersions and dispersible-polymer-powder markets of Europe, the Americas and Asia. WACKER intends to strengthen its position in the attractive vinyl acetate/ethylene copolymer segment, where it aims to be a key supplier. We plan to boost our market share of construction-sector dispersible polymer powders and provide greater added value for customers via specific product properties. To do so, we are expanding our network of technical centers worldwide.

WACKER POLYSILICON focuses on rapidly expanding production capacities for the electronic and solar industries. In October 2008, WACKER therefore decided to build a new polysilicon production plant with an annual nominal capacity of 10,000 metric tons in Nünchritz (Germany). Thanks to its Nünchritz expansion program, we can reach a total annual nominal capacity of 35,500 metric tons by year-end 2011, thereby further strengthening WACKER's market position. As in our other divisions, WACKER POLYSILICON pursues a policy of boosting its supply chain. By founding a joint venture with SCHOTT Solar, we achieved vertical integration within the solar industry. We are therefore not only a pure polysilicon supplier, but also a manufacturer of ingots and multicrystalline solar wafers.

Having restructured its product portfolio, WACKER FINE CHEMICALS now concentrates on the pharmaceutical and food sectors. In coming years, WACKER intends to press ahead with expansion into white biotechnology (industrial production) and its red counterpart (pharmaceuticals), aiming at annual double-digit growth. With its two bioengineered product groups – cyclodextrins and cysteine (white biotechnology) – WACKER, according to in-house research, already enjoys a large market share. Further investments aim to spur growth in these markets. Thanks to our unique, *E.coli*-based protein secretion technology, contract manufacturing of pharmaceutical proteins (red biotechnology) got off to a good start. We are striving for annual double-digit growth in this field, too.

59

Overview
of Business
Development

65

Profitability

68

Assets

71

Financial
Position

76

Segments

82

Regions

83

Further
Information

99

Risk Manage-
ment Report

106

Supplementary
Report

CH3

WACKER POLYMERS ...//



Environmentally-Compatible Packaging Adhesives with Superior Cost/Benefit Ratio

...// In adhesives, VINNAPAS® polymer dispersions enable reliable and robust packaging. The correct polymer dispersion is essential for optimal adhesion, high thermal stability and outstanding processability – thereby providing reliable protection against damp and dirt. Always at the cutting edge, water-based VINNAPAS® dispersions couple cost efficiency with climate protection. These dispersions are thus a time-tested and successful product from WACKER POLYMERS – a global leader in polymer additives and dispersions.

Economic Trends

The global financial crisis, triggered by the US housing slump, impacted world economic growth in 2008. Without massive government intervention, the entire financial system would probably have collapsed. The second half of 2008, in particular, saw a significant slowdown in the global economy. Leading economic research institutes consequently revised their growth forecasts for 2008. The downturn spread worldwide and will continue in 2009. According to International Monetary Fund (IMF) estimates, the global economy grew just 3.4% in 2008 (2007: 5.0%).

Global Economic
Downturn since
the Second Half
of 2008

In the USA, economic growth weakened yet again compared to the prior year. According to the IMF, GDP rose 1.1% (2007: 2.0%). For years, the US economy had been driven largely by debt-fueled consumer spending. Unemployment, the stock-market crisis and housing slump all persuaded countless consumers to cut spending. This adversely impacted such key industrial sectors as the auto industry, and accelerated the downturn.

Economic growth remained strong in Asia, although it, too, felt the first signs of a slowdown during 2008. The Asian Development Bank (ADB) expects the region's economy to grow 7.5% (2007: 9.0%). Chinese growth was even stronger, due to the continued, high investment level and increased consumer spending. According to ADB figures, Chinese GDP is set to grow 9.5% (2007: 11.9%). In contrast, Japan's economy stalled. The IMF expects the Japanese economy to shrink 0.3% in 2008 (2007: +2.1%).

After four years of healthy growth, Europe did not escape the effects of the slowdown. The IMF predicts growth of 1.0% (2007: 2.6%). While exports continued to provide momentum, consumer spending dropped. Some European countries, notably Spain and the UK, experienced a radical correction of housing prices.

The German economy weakened, too. Based on official federal statistics, German GDP grew 1.3% (2007: 2.5%). As in previous years, the rise was due to the high level of German exports. However, since December 2007, German industry has seen orders falling with each passing month, and a drop is to be expected in 2009.

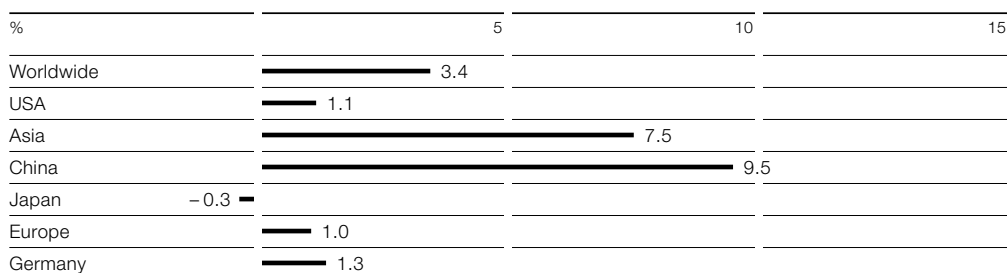
GDP Trends in 2008

Sources: worldwide: IMF, USA: IMF, Asia: ADB, China: ADB, Japan: IMF, Europe: IMF, Germany: Federal Statistics Office

General Sector-Specific Conditions

WACKER makes products for a wide range of industrial sectors. Its main customers are the semiconductor, solar, chemical, construction, energy, electronics and textile industries.

The semiconductor market did not grow in 2008. According to Gartner, the market research institute, sales dropped 16.3% in the year under review. As a result, the global silicon-wafer market was unable to make gains either. Overcapacities and weakened demand depressed prices for both wafers and semiconductor chips.

The photovoltaic (PV) market continued its positive trend in 2008. According to a sustainability study commissioned by Sarasin, a Swiss bank, about 4 gigawatt (GW) of new capacity was installed worldwide (2007: 2.3 GW). When it comes to the installation of solar capacity, Germany, Spain, Japan and the USA lead the way (source: European Photovoltaic Industry Association – EPIA). Around 3.2 GW of the total was installed in Europe alone. The market was driven by state subsidies and the high costs of conventional fuels. Crystalline polysilicon remains the principal raw material for photovoltaic modules. This benefits WACKER, too. In 2008, our nominal capacity rose by 4,500 metric tons. Year-end nominal capacity was up 50% to 15,000 tons.

Installation of New PV Capacity in 2007 and 2008

	Installation of New PV Capacity (MW)		CAGR' 07-08 %
	2008	2007	
Germany	1,703	1,135	50.0
Spain	1,050	512	105.1
Other European countries	434	133	226.3
USA	341	207	64.7
Asia	434	314	38.2
Other regions	118	56	110.7
Total	4,080	2,357	73.1

Source: Sarasin Bank, November 2008; 'CAGR: compound annual growth rate

Global chemical production weakened in 2008. Demand for chemicals was particularly slow in the second half of 2008. The German Chemical Industry Association (VCI) estimates that worldwide chemical production rose just 2.2% in 2008. Chemicals worth €2.4 trillion were produced worldwide. 2008 saw Germany's chemical industry stagnate, mainly due to lower automotive and construction-sector demand. It was only through price increases that year-on-year sales rose 3.0% to €178.8 billion.

Based on calculations presented by the Global Insight market research institute, global construction activity grew 2.5% in 2008, generating sales of over €4.4 trillion. Asia was the main growth engine. Construction activities in the US suffered from the financial and housing crisis, while Europe remained at the prior-year level. The construction-sector slow-down intensified in the second half of 2008, as reflected, for example, in WACKER's sales trend. Only in Asia did our construction business grow from June to December 2008.

The world's electrical and electronic goods markets suffered from sluggish demand in the year under review, having generated sales of some €2.5 trillion in 2007. Yet they remain the biggest market. The second half of 2008 in particular saw a drop in sales. They rose in the investments goods sector, such as automation and power engineering, but fell sharply in IT and communications technology.

Key Events Affecting Business Performance

Acquisitions

Our 2007 annual report already looked in detail at WACKER's acquisition of the shares previously held by Air Products and Chemicals Inc. in our two former partner companies – Air Products Polymers (APP) and Wacker Polymer Systems (WPS). The full consolidation of these APP activities within the WACKER Group took effect on February 1, 2008. Since then, their sales, expenditures, earnings and resultant payment flows have been included in our income and cash flow statements. Moreover, the assets and debts that were acquired have impacted our figures. APP were fully integrated into WACKER by year-end.

Integration of Air Products' Business Completed

Divestitures

Effective September 30, 2008, WACKER sold its PIOLOFORM® polymer binder specifications to Kuraray, a Japanese polymer manufacturer. Until their divestiture, PIOLOFORM® products generated sales in the lower double-digit million range for WACKER POLYMERS. The divestiture was motivated by limited industrial growth opportunities for polyvinyl butyrals.

Investment Decisions

In October, WACKER decided to further expand its polysilicon production capacity. With a nominal capacity of 10,000 metric tons, "Expansion Stage 9" is to be built at our Nünchritz site. Capital expenditures will amount to about €760 million. Burghausen's "Expansion Stage 8" – currently under construction – is to be extended from 7,000 to 10,000 tons. WACKER is investing around €100 million here.

Comparing Actual with Forecast Performance

Wacker Chemie AG looks back on a successful 2008. The Group has set new sales and EBITDA records.

At the start of 2008, WACKER predicted that sales would grow by well over 10%. We were on target, thanks to a 13.7% increase to €4.30 billion (2007: €3.78 billion). We did not quite meet our target of increasing WACKER POLYMERS' sales to about €1 billion. The construction-sector downturn led to a sharp decline in demand for dispersible polymer powders and dispersions. Sales therefore amounted to €867.9 million. At WACKER POLYSILICON, sales rose by a greater than expected amount, as initial quantities from "Expansion Stage 7" were sold ahead of schedule.

WACKER Reached its 2008 Sales and EBITDA Goals

Comparing Actual with Forecast Performance

	Result 2007	March 2008 Forecast	Result 2008
Sales revenue	€3.8 billion	well over 10 % sales growth	€4.30 billion (13.7 %)
EBITDA	€1.0 billion	> €1.0 billion	€1.06 billion
CAPEX	€699.3 million	€1.0 billion	€1.09 billion
Investments (asset additions)			€916.3 million
Acquisition of Air Products' shares			€171.2 million

We predicted that EBITDA would exceed €1 billion. Indeed, year-end EBITDA of €1.06 billion met expectations.

The 2008 dividend to be proposed by the Executive and Supervisory Boards at the Annual Shareholder Meeting is €1.80 per share. This means that 20.4 % of net income is to be distributed to shareholders. → See further details on dividends on page 73

WACKER had earmarked some €1 billion for capital expenditures in 2008. Spending totaled €916.3 million – excluding acquisition of Air Products' shares in our two former partner companies, APP and WPS. Additionally, we invested €171.2 million in the full-share acquisition of APP and WPS – two former joint ventures.

Employee numbers rose by 878 to 15,922 in 2008. The main reason for this increase was the integration of former APP employees.

At €163.2 million, R&D spending was slightly higher than the prior-year level.

In 2008, the general economic trend was much tougher than expected. The acquisition of APP and its subsequent integration into WACKER POLYMERS gave us an above-average sales boost in the USA. WACKER also experienced further sales gains in Germany and Asia – our core markets. Sales in the rest of Europe remained at prior-year levels.

Weak construction-sector performance was the main factor hampering our business. Our semiconductor segment had to cope with lower demand for electronic consumer goods and price pressure, particularly on 300 mm wafers. To compensate for this, we sold mono-crystals and other silicon by-products to the solar industry. Since demand for solar-grade hyperpure polycrystalline silicon remained high, we again made sales and earnings gains.

Management Review of Business Development

2008 was the most successful year in WACKER's history. Sales and EBITDA reached new Group peaks. In spite of our high investment level, WACKER is solidly financed and continues to have a stable equity base. We met all our key targets for 2008. By acquiring APP's operations, we have become the only market player to offer a complete supply chain in the Americas, Asia and Europe. WACKER POLYSILICON's "Expansion Stage 7" went on stream six months earlier than planned. Further production-capacity expansion enables us to benefit from rising solar-sector demand for polysilicon. → [See further details](#)

on page 79

WACKER managed to continue its positive business trend in 2008, posting new sales gains. Sales amounted to €4.30 billion (2007: €3.78 billion) – up 13.7%. The increase is due to several factors: the consolidation of Air Products' dispersion business, volume gains, higher prices for our products and strong customer demand in several target markets. WACKER POLYSILICON generated the biggest sales increase, up 81.2% to €828.1 million. At WACKER POLYMERS, too, sales rose, climbing 37.2% to €867.9 million (2007: €632.8 million). The main growth driver was the consolidation of the sales of Air Products' business which we had acquired. Sales also rose slightly at our largest division, WACKER SILICONES, up 3.5% to €1.41 billion (2007: €1.36 billion). Lower semiconductor-wafer demand caused Siltronic's sales to drop 6.3% to €1.36 billion (2007: €1.45 billion). Similarly, sales at our smallest division, WACKER FINE CHEMICALS, were 13.1% below the prior-year level – as expected due to plans to discontinue certain products. The following table shows external sales (without inter-divisional sales).

Sales Crossed the
€4 Billion Mark

External Sales by Division

€ million	2008	2007	2006	2005	2004
SILTRONIC	1,356.2	1,445.1	1,257.6	912.5	812.5
WACKER SILICONES	1,363.5	1,313.6	1,243.9	1,081.8	1,008.9
WACKER POLYMERS	860.4	623.7	548.9	473.0	424.1
WACKER POLYSILICON	567.0	243.8	132.7	132.5	109.1
WACKER FINE CHEMICALS	92.0	100.6	101.4	104.1	94.5
Other	59.0	54.5	52.4	51.8	55.2
Group	4,298.1	3,781.3	3,336.9	2,755.7	2,504.3

WACKER generated 77.9% or €3.35 billion of Group sales abroad. During the year under review, business in the Americas rose to €852.9 million, up 32.7%. The consolidation of Air Products' polymer operations was a contributory factor. Sales in Europe amounted to €1.01 billion. In Asia, sales continued to grow. At €1.36 billion, they were up 7.6% on the prior year. Amounting to 22.1% or €948.6 million (2007: €723.5 million), domestic sales rose 31.1% year on year.

Domestic and International Sales (By Customer Location)

€ million	2008	2007	2006	2005	2004
External sales	4,298.1	3,781.3	3,336.9	2,755.7	2,504.3
Thereof domestic	948.6	723.5	657.6	572.3	566.6
Thereof international	3,349.5	3,057.8	2,679.3	2,183.4	1,937.7

Earnings before interest, depreciation, taxes and amortization (EBITDA) did not grow quite as strongly as sales. At €1.06 billion (2007: €1.00 billion), EBITDA rose 5.4%. Volume growth, price increases and productivity boosts had a positive impact. In contrast, earnings were impacted by increased energy and raw material costs, and negative effects on sales due to exchange rates. The EBITDA margin was 24.6%, slightly down on 2007's 26.5%.

At €647.9 million (2007: €649.6 million), earnings before interest and taxes (EBIT) remained at the prior-year level. Whereas gross profit rose €36.0 million to €1.19 billion, investment income fell €31.8 million to €-33.4 million.

With sales climbing 13.7% selling, administrative and R&D expenses only rose a relatively low 10.5% to €530.3 million (2007: €480.1 million). Selling costs grew the fastest – up €24.1 million to €257.6 million (2007: €233.5 million). R&D and administrative costs rose slightly, with the former amounting to €163.2 million (2007: €152.5 million) and the latter totaling €109.5 million (2007: €94.1 million).

In 2008, the balance of other operating income and expenses totaled €23.6 million, up on 2007's €-20.7 million. This is due to exchange-rate effects and to income relating to the APP takeover and income from the disposal of assets. The balance of currency gains and losses increased compared to the previous year from €10.2 million to €23.5 million. In contrast, impairments for property, plant and equipment increased other operating expenses.

The year-on-year interest result was positive. This was due to operational cash flow surpluses and customer prepayments received at WACKER POLYSILICON, which we subsequently invested. The interest result was €5.7 million (2007: €-1.0 million).

Year-on-year investment income – the total income from investments in joint ventures and associates and other income from participations – is distinctly down, amounting to €–33.4 million (2007: €–1.6 million). This was due to start-up losses stemming from investments in joint ventures and associates. WACKER bears a share of these losses, which affect the following minority interests: Siltronic Samsung Wafer and the Zhangjiagang-based WACKER/Dow Corning joint venture (siloxane production plant). At the same time, investment income no longer includes the positive net results from WACKER's two former partner companies with Air Products, because these have been fully acquired by WACKER.

Tax expenses declined slightly to €203.5 million in fiscal 2008 (2007: €209.9 million). The tax rate was thus 32% (2007: 33%).

In total, net income rose €16.1 million to €438.3 – up 3.8%.

Summarized Income Statement

€ million	2008	2007
Sales	4,298.1	3,781.3
Gross profit from sales	1,188.0	1,152.0
Selling, R&D and general administrative expenses	– 530.3	–480.1
Other operating income and expenses	23.6	–20.7
Operating result	681.3	651.2
Income from participations (including investments in joint ventures and associates)	– 33.4	–1.6
EBIT (earnings before interest and taxes)	647.9	649.6
Financial result	– 6.1	–17.5
Income before taxes	641.8	632.1
Income taxes	– 203.5	–209.9
Net income before minority interests	438.3	422.2
Thereof attributable to Wacker Chemie AG shareholders (net income)	439.4	422.0
Thereof attributable to other minority interests	– 1.1	0.2
Earnings per share	€ 8.84	8.49
EBITDA	1,055.2	1,001.5
ROCE	% 25.7	25.3

Balance-Sheet Trend: Assets

Effective December 31, 2008, the WACKER Group's balance-sheet total made clear gains, up €707.0 million – or 18% – to €4.63 billion (2007: €3.92 billion). This growth resulted from higher business volumes and is made particularly apparent by the increase in noncurrent assets. The rise in current assets was only slight, primarily due to higher inventories. Current assets rose 3% to €1.46 billion (2007: €1.43 billion).

The WACKER
Group's Balance-
Sheet Total Made
Clear Gains

Among the noncurrent assets, property, plant and equipment showed the strongest growth. This was due to the further rise in capital expenditures, particularly at WACKER POLYSILICON, and the addition represented by our acquisition of Air Products' dispersion business. The carrying amount of property, plant and equipment climbed to €2.66 billion (2007: €2.12 billion). Compared to the prior-year figure, this represents a €536.2 million or 25% gain.

The carrying amounts of the minority interests accounted for using the equity method and of the noncurrent financial assets remained almost unchanged. On the reporting date, they were €263.8 million (2007: €266.9 million), down €3.1 million or 1%. The decline is essentially due both to the disposal from noncurrent financial assets of our stakes in the APP companies amounting to €63.1 million and to the pro rata net income stemming from investments in joint ventures and associates. A €60.3 million shareholder loan to our Siltronic Samsung Wafer joint venture and a capital contribution to our siloxane-production joint venture with Dow Corning had the opposite effect. Other noncurrent assets made significant gains, up €105.1 million to €164.2 million (2007: €59.1 million). This is due to prepayments paid by WACKER SCHOTT Solar Vertriebs GmbH (our sales joint venture) to WACKER SCHOTT Solar Produktion (a production joint venture).

As for current assets, the main increase affected inventories, up 25% to €504.9 million (2007: €403.5 million). In contrast, cash and cash equivalents fell €61.2 million to €305.3 million. WACKER's cash and cash equivalents as per December 31, 2008 included for the first time securities in the form of German government securities (Bundeswertpapiere). For reasons of risk diversification, surplus cash and cash equivalents were invested in this current asset. Much higher sales saw trade receivables climbing only €6.2 million to €466.8 million (2007: €460.6 million). Similarly, other assets, including tax receivables, fell slightly, dropping €9.8 million to €187.1 million (2007: €196.9 million). The decline was mainly due to lower receivables stemming from investment subsidies.

Balance-Sheet Trend: Liabilities

Primarily due to the high net profit, the Group's equity on the reporting date rose €217.2 million to €2.08 billion (2007: €1.87 billion) – an increase of 12%. The balance-sheet total caused a slight drop in our equity ratio, which is now 45.0% (2007: 47.6%). WACKER distributed dividends in 2008 amounting to €149.4 million. Changes due to currency translation of foreign subsidiaries' financial statements and to currency-hedging measures on balance increased equity by €7.4 million.

Noncurrent and current financial liabilities rose by €54.6 million year on year. The increase results from financing measures needed for investments made by Group companies in China. Provisions for pensions, in contrast, hardly changed at all. As per December 31, 2008, financial liabilities amounted to €272.4 million (2007: €217.8 million). This amount included €56.3 million (2007: €67.4 million) in liabilities stemming from financial leasing €158.7 million (2007: €164.2 million) were noncurrent and €113.7 million (2007: €53.6 million) were current financial liabilities. Net financial liabilities (the balance of financial liabilities and cash and cash equivalents) dropped year on year. On the reporting date, cash and cash equivalents exceeded financial liabilities by €32.9 million.

Altogether, noncurrent liabilities rose 17% to €1.70 billion (2007: €1.46 billion). Prepayments received for future polysilicon deliveries are the main reason for the increase in other noncurrent liabilities, up €246.1 million.

Corporate Acquisitions and the Sale of Corporate Entities

In 2008, we concluded our acquisition of Air Products' shares in APP and WPS, formerly joint ventures. The companies, which had not been fully consolidated until now, have a major impact on our assets. When these companies were first consolidated on February 1, 2008, their assets amounted to €231.0 million, with debts at €55.8 million.

In fiscal 2008, WACKER did not sell any major corporate entities that would have significantly impacted assets.

Off-Balance-Sheet Assets

A major asset that does not appear on the balance sheet is the value of the WACKER brand and other Group trademarks. We consider the high profile and reputation of our trademarks to be a key influencing factor in the acceptance of our products and solutions by customers. However, there are other intangible assets that are vital for success and positively impact our business. These include long-standing relationships with customers and their trust in our product and solution-related expertise. Just as important are factors such as profound know-how and the experience of our employees, as well as our many years of expertise in R&D, production/business-process structures and project management.

Summarized Balance Sheet as per December 31

€ million	2008	2007
Assets		
Intangible assets/property, plant and equipment	2,687.9	2,135.0
Investments in joint ventures and associates	191.8	196.2
Other noncurrent assets	281.3	159.4
Noncurrent assets	3,161.0	2,490.6
Inventories	504.9	403.5
Trade receivables	466.8	460.6
Other current assets	492.4	563.4
Current assets	1,464.1	1,427.5
Total assets	4,625.1	3,918.1
Liabilities		
Equity	2,082.8	1,865.6
Minority shares in limited partnership capital	–	32.6
Noncurrent provisions	637.1	614.2
Financial liabilities	158.7	164.2
Other noncurrent liabilities	907.1	649.9
Thereof customer prepayments	836.2	604.7
Noncurrent liabilities	1,702.9	1,460.9
Financial liabilities	113.7	53.6
Trade payables	296.7	241.8
Other noncurrent provisions and liabilities	429.0	296.2
Current liabilities	839.4	591.6
Liabilities	2,542.3	2,052.5
Total equity and liabilities	4,625.1	3,918.1
Capital employed	2,520.6	2,566.9

The primary aim of our financial policies is to bolster WACKER's financial strength. The focal task is to sufficiently cover the financial needs of our operational business and investment projects. Organized centrally, the Group's financial management experts are responsible for cash management and financing, as well as hedging against currency and interest-rate risks. A groupwide financial regulation sets out tasks and responsibilities.

→ See further details on page 52

Financial Analysis

Effective December 31, 2008, financial liabilities rose €54.6 million. Net financial liabilities, however, showed a credit balance of €32.9 million on the reporting date. This takes account of €305.3 in cash and cash equivalents. Aside from the financial liabilities posted in the report on assets, WACKER has sufficient unused credit lines available to secure the financing of additional future investments. The Group does not use off-balance-sheet financial instruments.

Net Financial Liabilities Showed a Positive Credit Balance

Cash Flow

WACKER's internal financial strength weakened somewhat in 2008. Cash flow from operating activities amounted to €1.01 billion (2007: €1.32 billion), falling 24.0%. This is due to the fact that customer prepayments for future polysilicon shipments did not match prior-year levels. Cash inflows from prepayments were €197.7 million (2007: €413.2 million). In contrast, the inflow from net income rose to €438.3 million (2007: €422.2 million). HR provisions and depreciation likewise increased. Depreciation rose €55.4 million to €407.3 million. Trade receivables positively impacted our cash inflow. This is due to our rigorous receivables management. Adjusted for exchange-rate effects, trade receivables fell €25.7 million, whereas there had been an increase of €4.0 million in 2007.

Cash Flow from Operating Activities (Gross Cash Flow)

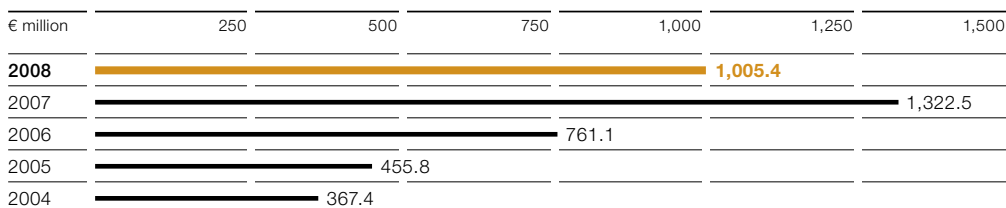

Liquidity outflows for investments in intangible assets, property, plant, equipment and financial assets rose substantially in 2008 – rising to €983.7 million (2007: €678.8 million). This is an increase of €304.9 million. Most of the funding flowed into production facilities for polysilicon, siloxane, silicon wafers and dispersible polymer powders. After deduction of the cash and cash equivalents acquired from the APP companies, €171.2 million was paid out to acquire Air Products' stakes in our two former partner companies – Air Products Polymers (APP) and Wacker Polymer Systems (WPS). Investments in our two joint ventures with Samsung Electronics and Dow Corning amounted to €86.5 million. → See further details on page 76, 77

Cash Flow from Investing Activities

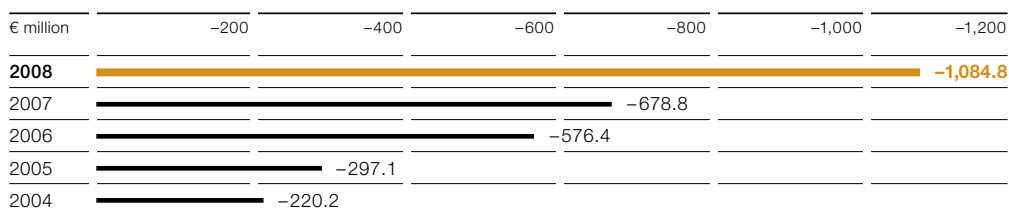

Net cash flow (the difference between cash inflow from operating activities and cash outflow due to investment activities) amounted to €21.7 million in 2008 (2007: €643.7 million) – a year-on-year decline of €622.0 million.

Net Cash Flow

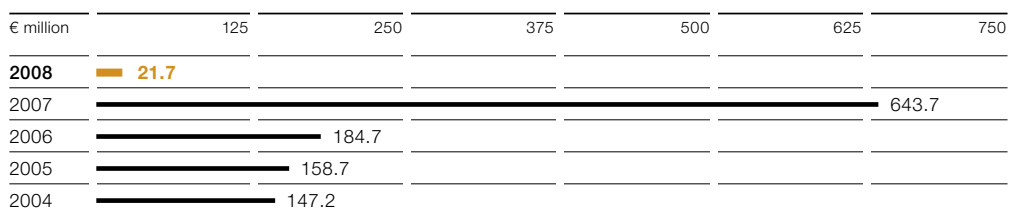

In fiscal 2008, cash outflow from financing activities totaled €87.7 million (2007: €318.9 million). Key items here included the distribution of dividends to shareholders (primarily to Wacker Chemie AG shareholders amounting to €149.1 million) and the buildup of financial liabilities of €59.3 million. Most of the funding went to our Chinese holdings to press ahead with the continued expansion of our operations there.

Proposal on Appropriation of Profits

In accordance with German Commercial Code accounting rules, Wacker Chemie AG posted a retained profit of €576.9 million in 2008. The Executive and Supervisory Boards will propose a dividend of €1.80 at the Annual Shareholder Meeting. We are thus letting shareholders participate in the good result that WACKER achieved in 2008. At the same time, we are taking account of the expected decline in business in 2009. Based on the dividend-entitled shares as per December 31, 2008, the cash dividend corresponds to a payout of €89.4 million.

Calculated in relation to WACKER's average share price in 2008, the dividend yield is 1.5%.

At the Annual Shareholder Meeting, the Executive and Supervisory Boards will propose treating the remaining amount as profit carried forward.

Rating

WACKER has sufficient unused credit lines available at banks and does not use financial instruments such as bonds and commercial paper. This is why WACKER has not published a credit rating so far.

General Overview of the Business Situation

The WACKER Group maintained its growth course in 2008. In spite of much higher capital expenditures, WACKER still has a strong equity base. Additionally, cash and cash equivalents exceed current and noncurrent financial liabilities. WACKER is thus free of debt.

Supplemental information. German Takeover Directive Implementation Act

The following table contains information required by Section 315, Subsection 4 of the German Commercial Code (HGB):

Regulation	Topic	Details and references
§ 315 (4) 1	Composition of subscribed capital	Wacker Chemie AG's subscribed capital totals 52,152,600 non-par value voting shares. There are no differences in share category. The total number of shares currently includes 49,677,983 held by external shareholders and 2,474,617 held by Wacker Chemie AG itself. WACKER's treasury shares were acquired by repurchasing Wacker-Chemie GmbH shares in August 2005 when it was still a private limited company. The Executive Board can only use or sell these treasury shares under the following conditions: 782,300 shares require Supervisory Board approval and an appropriate resolution by the Annual Shareholder Meeting. The remaining 1,692,317 shares are subject to Supervisory Board approval.
§ 315 (4) 2	Restrictions on voting rights or on the transfer of shares	There are no restrictions on voting rights or the transfer of shares.
§ 315 (4) 3	Direct or indirect capital stakes	Dr. Alexander Wacker Familiengesellschaft mbH, based in Munich, and Blue Elephant Holding GmbH, based in Pöcking, each hold over 10% of the subscribed capital.
§ 315 (4) 4	Owners of shares entailing special rights	Shareholders have not been given any special rights that bestow control powers. Insofar as employees hold shares in Wacker Chemie AG's capital, they exercise their resultant control rights directly.
§ 315 (4) 5	Method of voting-right control in the case of employee participation	
§ 315 (4) 6	Legal stipulations and articles of incorporation principles regarding the appointment and dismissal of executive board members and amendments to said articles	Provisions to appoint and dismiss Wacker Chemie AG's Executive Board members are based on Sections 84 et seq., of the German Stock Corporation Act (AktG). Wacker Chemie AG's Articles of Incorporation do not contain any further provisions in this respect. Pursuant to Section 4 of the Articles of Incorporation, the number of Executive Board members is fixed by the Supervisory Board, which also appoints an Executive Board member as President & CEO. Amendments to the Articles of Incorporation are covered by Sections 133 and 179, AktG. In accordance with Section 179, Subsection 1, item 2, AktG, the Supervisory Board has been empowered to amend the Articles of Incorporation if only the wording thereof is affected.

Regulation	Topic	Details and references
§ 315 (4) 7	Authority of the executive board to issue or buy back shares	In accordance with a resolution passed at the March 15, 2006 Annual Shareholder Meeting, Wacker Chemie AG's Executive Board was authorized – in compliance with the legal provisions set out in Section 71, Subsection 1, No. 8 of the German Stock Corporation Act (AktG) – to acquire treasury shares totaling a maximum of 10% of capital stock. No capital has been authorized for the issue of new shares.
§ 315 (4) 8	Major agreements associated with control changes due to takeover bid	Various agreements with joint-venture partners include "change of control" clauses. These clauses deal with what might happen if one of the joint-venture partners were taken over. These arrangements comply with the usual standards for such joint-venture agreements.
§ 315 (4) 9	Severance agreements with the executive board or employees in the event of a takeover bid	There are no severance agreements etc. with employees or with Executive Board members in the event of a takeover bid (please refer to the Compensation Report).

In sum, there are no special arrangements for share-related voting rights or any resultant control opportunities, whether due to special share categories or restrictions on voting rights or transfers. Provisions to appoint or dismiss Executive Board members do not go above and beyond legal requirements. Should there be a takeover bid, no major WACKER divisions and activities can be given up as a result of existing "change of control" clauses.

Siltronic

In 2008, Siltronic's sales amounted to €1.36 billion (2007: €1.45 billion) – down 6.3% year on year. The reason for the drop in sales was weak semiconductor-sector demand, which particularly impacted Siltronic's Q4 business. The prices of all wafer diameters dropped. By selling monocrystals and other materials to the solar industry, Siltronic partially offset its lower semiconductor-sector sales.

Semiconductor-
Industry Demand
Fell in 2008

2008 EBITDA amounted to €357.3 million (2007: €478.1 million), down 25.3%. Consequently, the EBITDA margin dropped to 26.3 percent (2007: 32.9%). Key negative factors for the earnings trend included declining average wafer prices and high average euro/dollar exchange rates. In contrast, sales of silicon monocrystals substantially bolstered Siltronic's profitability. At the same time, Siltronic introduced various productivity-boosting and cost-cutting measures. Since Siltronic procured less polysilicon from WACKER POLYSILICON due to weaker demand in Q4, the quantities that WACKER POLYSILICON did not sell were instead sold to the solar industry on the polysilicon market. Siltronic received a credit note of €6.7 million from the income generated by these sales.

During 2008, Siltronic invested €199.6 million (2007: €200.0 million). A considerable sum was spent on optimizing the Freiberg and Burghausen production plants. Investments also focused on the new 300 mm fab in Singapore that Siltronic built in partnership with Samsung Electronics. This joint venture started production in June 2008. By year-end 2009, the facility is expected to produce around 200,000 wafers per year. Some US\$1 billion has been invested in the new production facility, which will ultimately have an annual capacity of 300,000 wafers.

Siltronic had 5,469 employees on December 31, 2008 (December 31, 2007: 5,634).

Key Data: Siltronic

€ million	2008	2007	2006	2005	2004
Total sales	1,360.8	1,451.6	1,263.1	925.0	813.7
EBITDA	357.3	478.1	355.6	166.7	58.0
EBIT	193.8	337.2	213.1	5.8	-100.7
Capital expenditures	199.6	200.0	167.7	68.0	187.3
R&D expenses	67.7	63.9	63.2	65.4	71.0
Employees (number as of December 31)	5,469	5,634	5,585	5,631	6,032

WACKER SILICONES

WACKER SILICONES boosted its total 2008 sales by €47.6 million to €1.41 billion (2007: €1.36 billion) – an increase of 3.5%. Sales volumes grew, thanks to growing demand for silicone products, particularly in industries such as electronics, photonics, medical technology and silicone rubber. At the same time, the division pushed higher market prices through. Exchange-rate effects adversely impacted our sales development. WACKER SILICONES generated its highest sales growth rates in Asia, eastern Europe and the Middle East. In contrast, business in the USA and western Europe was subdued.

Sales Rise Due to
Higher Demand for
Silicone Products

EBITDA was lower than in the previous year. At €167.9 million (2007: €226.9 million), EBITDA was 26.0% down against 2007. Raw material costs were significantly higher than in the prior-year period, particularly for silicon metal. The same applies to energy and transport expenditures. As a result, the EBITDA margin dropped to 11.9% (2007: 16.7%). Having raised prices for all its silicone products from January 1, 2008, the division introduced further price increases on October 1, 2008.

Investments focused on further expanding the Zhangjiagang site in China. Divisional investments totaled €107.0 million (2007: €102.2 million). The first expansion stage of the new siloxane and pyrogenic silica production facilities in Zhangjiagang began operating in November 2008. In partnership with Dow Corning, WACKER is building the world's largest integrated silicone production site there. Full nominal capacity is expected by year-end 2010. In September 2008, the division started up two new production facilities for silicone polymers and sealants at its Nünchritz (Germany) site, which specializes in silicones. Nünchritz celebrated its 10th anniversary as a WACKER site in October 2008. Over the last 10 years, WACKER has invested more than €550 million to transform Nünchritz into a world-class production site.

WACKER SILICONES had 3,927 employees on December 31, 2008 (December 31, 2007: 3,871).

Key Data: WACKER SILICONES

€ million	2008	2007	2006	2005	2004
Total sales	1,408.6	1,361.0	1,286.9	1,119.3	1,045.4
EBITDA	167.9	226.9	231.9	211.0	189.9
EBIT	86.3	144.6	147.8	111.5	105.8
Capital expenditures	107.0	102.2	140.9	102.9	107.0
R&D expenses	31.5	35.9	34.4	33.4	33.1
Employees (number as of December 31)	3,927	3,871	3,767	3,596	3,596

WACKER POLYMERS

At WACKER POLYMERS, total 2008 sales rose appreciably. This is mainly attributable to the full consolidation – effective February 1, 2008 – of the dispersion business acquired from our former partner Air Products. Divisional sales climbed 37.2% to €867.9 million (2007: €632.8 million). The sales trend was hit by the construction-sector downturn. Demand for dispersible polymer powders and construction dispersions fell in the USA, Europe and China. So, sales volumes for these products were somewhat lower than in the previous year. The price increases WACKER achieved did not fully offset the downturn in demand.

Acquisition of Air Products' Dispersion Business Boosts Sales

However, the acquisition of Air Products' dispersion business led to additional, consolidated sales. As a result, US and German sales made significant gains, and Asia, too, saw divisional sales increase. Integration of the dispersion business into the WACKER Group was successfully completed in 2008.

As in the prior year, WACKER POLYMERS' profitability was hampered by high raw material and energy prices, as well as by the unfavorable euro/dollar exchange rate. Although oil prices fell in the second half of 2008, ethylene costs were above the prior-year level. The division generated EBITDA of €108.9 million (2007: €107.0 million). Given the much higher sales gains, the EBITDA margin dropped from 16.9% to 12.5%.

Year-on-year asset additions rose by €33.4 million to €74.4 million (2007: €41 million). Aside from this, €171.2 million was spent on acquiring Air Products Polymers and Wacker Polymer Systems – our former joint ventures. Further funding went to the ongoing expansion of our Nanjing (China) site and into optimizing existing production facilities.

To counter rising raw material and energy costs, the division raised prices and introduced a productivity-boosting program, focusing on cost-cutting and capacity-utilization measures. Amid weaker demand, production was channeled to the most efficient facilities. As a further measure, WACKER POLYMERS restructured its portfolio, disposing of PIOLOFORM® polymer binders. This business was taken over by the Japanese Kuraray Group on October 1, 2008. The purchase price paid (in euros) for the specifications was a single-digit million sum.

The acquisition of Air Products' dispersion business raised employee numbers to 1,579 on December 31, 2008 (December 31, 2007: 1,128).

Key Data: WACKER POLYMERS

€ million	2008	2007	2006	2005	2004
Total sales	867.9	632.8	559.6	473.8	424.9
EBITDA	108.9	107.0	106.6	99.1	102.6
EBIT	64.9	80.5	88.8	80.9	80.9
Capital expenditures	74.4	41.0	17.8	21.0	9.1
R&D expenses	15.0	7.6	7.1	7.9	7.4
Employees (number as of December 31)	1,579	1,128	1,050	1,000	986

WACKER POLYSILICON

In 2008, WACKER POLYSILICON forged ahead, building on its prior-year successes. Divisional sales climbed 81.2% to €828.1 million (2007: €456.9 million). Strong demand for polysilicon continued to drive growth. Higher prices fueled sales, as did higher sales volumes stemming from production-capacity expansion. Polysilicon output rose over 40% against 2007, reaching 11,900 metric tons. Volumes that could be freed up at short notice were sold at attractive terms on the polysilicon market throughout 2008. For the first time, growth was boosted by the WACKER SCHOTT Solar joint venture, which – thanks to its new Jena-based production facility for multicrystalline silicon wafers – generated double-digit million sales.

Strong Sales and Results Gains Due to Higher Sales Volumes

Despite higher energy and raw material costs, EBITDA grew even more than sales. EBITDA soared 132% to €422.0 million (2007: €182.2 million). The EBITDA margin likewise increased, reaching 51.0% (2007: 39.9%).

As in the past, the division's year-on-year investments rose substantially. Capital expenditures increased 58% to €410.3 million (2007: €259.5 million). The investment program mainly targeted the ongoing expansion of Burghausen's polysilicon production capacities. "Expansion Stage 7" came fully on stream in late June 2008, six months ahead of schedule. The planned nominal capacity of 4,500 metric tons per year was reached in late December 2008.

In October 2008, WACKER decided to build a new polysilicon production plant with an annual nominal capacity of 10,000 tons in Nünchritz (Germany). Full operational capacity is scheduled for year-end 2011. Investments for the project amount to €760 million. Another decision made in October 2008 was to increase the nominal capacity of Burghausen's "Expansion Stage 8," which is currently under construction. Annual capacity is set to increase to 10,000 tons, instead of the original 7,000. WACKER is investing €100 million there. Full capacity utilization is expected by year-end 2010. Thanks to these and other

ongoing expansion measures, WACKER's annual polysilicon capacity will rise from today's 15,000 metric tons to 35,500 tons by year-end 2011.

Due to production expansions, the number of WACKER POLYSILICON employees rose to 1,289 by December 31, 2008 (December 31, 2007: 1,003).

Key Data: WACKER POLYSILICON

€ million	2008	2007	2006	2005	2004
Total sales	828.1	456.9	325.6	288.1	258.8
EBITDA	422.0	182.2	118.3	90.2	74.5
EBIT	349.8	135.0	88.8	66.2	46.7
Capital expenditures	410.3	259.5	148.5	67.6	34.3
R&D expenses	5.4	6.3	5.1	5.3	6.0
Employees (number as of December 31)	1,289	1,003	875	832	769

WACKER FINE CHEMICALS

WACKER FINE CHEMICALS generated total sales of €97.7 million (2007: €112.4 million) in 2008, down 13.1 % year on year due to consolidation measures. WACKER stopped making some of its custom fine chemicals and catalog products. Higher sales of biotech products, such as biologics, cyclodextrins and cysteine, did not quite compensate for the shortfall. Europe continues to account for the largest share of divisional sales.

WACKER FINE CHEMICALS' 2008 EBITDA was almost at the prior-year level, dropping 3.2% to €9.2 million (2007: €9.5 million). The EBITDA margin was 9.4 % (2007: 8.5 %). Divisional earnings were positively impacted by the successful consolidation of chemical activities and demand for cyclodextrins and cysteine. WACKER FINE CHEMICALS is the world's only supplier of cysteine made from plant-based raw materials in a fermentative production process.

EBITDA Margin
Improved Despite
Lower Sales

In 2008, the division's capital expenditures amounted to €16.5 million (2007: €7.5 million). Spending focused on the ongoing expansion of its Jena (Germany) and Eddyville (Iowa, USA) sites. The division completed Jena's new lab facilities on schedule in late 2008 and is continuing to expand its existing biologics production facility there. The cyclodextrin production plant in Eddyville has been extended.

WACKER FINE CHEMICALS and MorphoSys AG are intensifying their collaboration for using WACKER's secretion technology to produce antibodies. This unique and highly efficient technology was also the basis for acquiring several new customer projects.

WACKER FINE CHEMICALS had 259 employees on December 31, 2008 (December 31, 2007: 245).

Key Data: WACKER FINE CHEMICALS

€ million	2008	2007	2006	2005	2004
Total sales	97.7	112.4	112.6	110.5	103.3
EBITDA	9.2	9.5	10.5	17.6	16.1
EBIT	6.0	-7.5	-4.5	10.1	8.5
Capital expenditures	16.5	7.5	4.0	13.2	3.6
R&D expenses	2.3	2.1	6.0	6.1	5.9
Employees (number as of December 31)	259	245	300	321	311

Other

During 2008, "Other" sales totaled €265.4 million (2007: €247.2 million). This 7.4% increase is due to greater demand for in-house corporate services and the passing on of higher energy costs to Group subsidiaries. In the year under review, "Other" EBITDA amounted to €-8.9 million (2007: €-2.2 million).

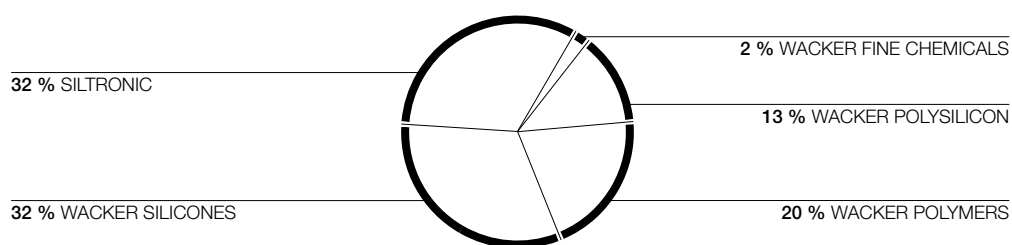
Divisional Shares in External Sales

Regions

In 2008, the WACKER Group posted sales of €4.30 billion (2007: €3.78 billion). WACKER generated 77.9% of its sales abroad and 22.1% in Germany. Asia took 31.7% of Group sales, once more making it the Group's principal market. At €1.36 billion, sales were up 7.6% (2007: €1.27 billion). The Greater China region (which includes Taiwan) accounted for €704.7 million (2007: €644.7 million) – a gain of 9.3%.

Asia – Largest Sales Region in 2008

External Sales by Customer Location

€ million	2008	2007	2006	2005	2004
Germany	948.6	723.5	657.6	572.3	566.6
Europe (excluding Germany)	1,008.2	1,034.7	960.8	840.0	831.4
Americas	852.9	642.6	659.2	615.3	547.2
Asia	1,362.8	1,267.1	961.4	639.3	559.1
Other regions	125.6	113.4	97.9	88.8	0.0 ¹
Group	4,298.1	3,781.3	3,336.9	2,755.7	2,504.3

¹ Asia/Other regions were still combined in 2004.

With 32.7% growth, the Americas recorded a marked year-on-year sales rise. This healthy increase was due to the consolidation of Air Products' dispersion business, which generates most of its growth in the Americas. Sales in this region rose €210.3 million to €852.9 million (2007: €642.6 million). Dispersion-business consolidation also benefited Germany, where sales climbed 31.1% to €948.6 million (2007: €723.5 million).

In European countries excluding Germany, WACKER generated sales of €1.01 billion in 2008 (2007: €1.03 billion) – a decline of 2.6% year on year.

External Sales by Group Company Location

€ million	2008	2007	2006	2005	2004
Germany	3,746.8	3,341.0	2,886.7	2,359.8	2,119.0
Europe (excluding Germany)	29.4	26.6	23.0	28.2	29.9
USA	736.4	659.1	700.8	647.5	571.2
Asia	546.3	480.2	418.9	305.3	339.0
Other regions	2.2	1.8	1.4	2.9	7.2
Consolidation	-763.0	-727.4	-693.9	-588.0	-562.0
Group	4,298.1	3,781.3	3,336.9	2,755.7	2,504.3

Research and Development

R&D expenditures in 2008 rose 7.0% to €163.2 million (2007: €152.5 million). The R&D quotient (research and development spending as a percentage of Group sales) is slightly lower than the prior-year figure due to 2008's strong sales growth. This quotient is now 3.8% (2007: 4.0%). WACKER's R&D goals are to offer customers even better products, develop novel solutions and set up new fields of work. Close customer collaborations are an integral part of R&D.

Close Collaboration with Customers on R&D Issues

WACKER's innovative strength is reflected in the number of patents and patent applications on file. In 2008, we filed for patents for 119 inventions. There are some 3,500 patents in the WACKER portfolio.

R&D Costs

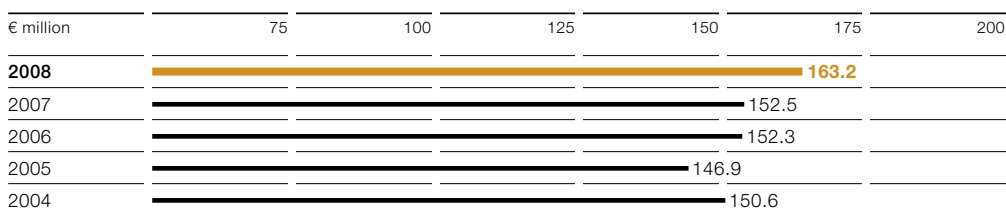

At WACKER, R&D progresses along two paths – central and decentral. The Group's individual business divisions mainly focus on semiconductor technology, silicone chemistry, polymer chemistry and biotechnology, as well as innovative processes for producing polycrystalline silicon. WACKER scientists have around 150 projects based on 40 technology platforms – frequently in collaboration with customers, universities and scientific bodies. R&D is supported by 17 technical centers worldwide that implement customers' local needs via market-oriented development.

Research Work at WACKER

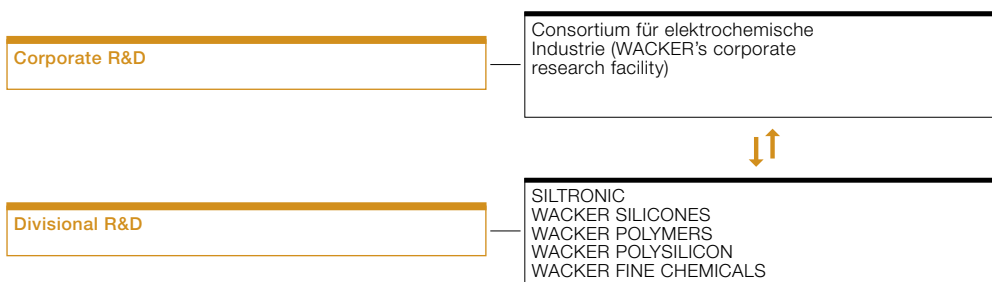

At the core of our R&D is the “Consortium für elektrochemische Industrie” (WACKER’s corporate research facility). It has over 200 employees currently conducting research and lab work in five departments: catalysis and processes, functional materials, polymers, organic synthesis, and biotechnology. The Consortium’s research work is wide-ranging. Research projects are identified groupwide via methodical observations and evaluations of technical and scientific developments. At the same time, we continually endeavor to optimize our production processes in terms of quality, environmental protection and costs.

2008 was another year in which our R&D activities continued to expand. WACKER operates in the innovative fields of photovoltaics, energy and white biotechnology. We strengthen our technology leadership as a producer of solar-grade polysilicon. We not only continually improve our silicon deposition process, but also our unique, closed production loop – which ranges from metallurgical silicon, hyperpure solar-grade and electronics-grade silicon, to silanes, silicones and pyrogenic silica.

In the semiconductor market, ICs are entering ever-smaller dimensions. It takes special skills to master the required geometries and ensure ideal crystal properties. A new chip generation in line with the 32 nanometer design rule (structural width) is about to start production, and processes for 22 nanometer design rules are being prepared.

Siltronic’s development work involves close collaboration with external research institutes. Development focuses on process simulations for a wide variety of production stages, on enhanced test methods, and on the manufacture of semiconductor materials with a hetero-epitaxial layer.

WACKER SILICONES launched several innovative elastomer products on the market, for example, UV-active silicone elastomers for encapsulating electronic components. Oven curing is no longer necessary, as our new products cure at room temperature. This saves energy and greatly reduces coating cycle times. The new elastomers' flexibility fully meets production demands in the automotive, power-electronics, sensor-technology and photonics sectors, where large quantities of electronic components are needed.

Novel Elastomer
Products

A new adhesive technique bonds silicones to other materials with particular ease. For the first time, no pressure is applied and no pretreatment is required: self-adhesive silicone rubber grades adhere to a wide range of substrates and can be used, for example, to coat plastics, metals, as well as textile or metal fabrics.

The WACKER portfolio includes new automotive-sector silicone elastomers. Oil-bleeding (i.e. self-lubricating) silicone rubber grades permit stable plug connectors that even withstand substantial mechanical stresses. Alternatively, oil-free, yet low-friction silicone elastomers are ideal for the automatic and cost-effective production of connector seals.

Our unique expertise – in not only silane, silicone and particle technology, but also polymer chemistry – enables us to produce copolymers from silicones. By combining the properties of different materials, we can synthesize specific, new properties. Take hybrid silicone polymers, for example, which combine flexible silicone molecules with organic polymer blocks. These hybrids make it possible to formulate hair sprays that give hairstyles a firm hold, yet confer good flexibility and excellent softness on the hair – properties that had previously been incompatible. Similar hybrids used in fabric softeners ensure that textiles are absorbent, but feel pleasant and soft.

Biotech and genetic engineering are two more innovative fields. They permit the synthesis of products that would be extremely difficult to achieve by other means – if at all. WACKER's bacteria-based ESETEC® secretion system is an economical method of producing biologics. In collaboration with MorphoSys AG, the technique is also used to produce antibody fragments for diagnostic and therapeutic applications. MorphoSys and WACKER intensified their cooperation in 2008. They signed a new agreement that specified application fields and defined exact product quantities. To meet rising customer demand, Wacker Biotech is increasing the size, production capacity and process-development expertise of its existing facility in Jena.

Economical
Method of
Producing
Biologics
Developed

Recently, this secretion system also succeeded in producing Anticalins® – engineered proteins that act as antibodies. These proteins are being developed by Munich-based Pieris AG for use in cancer treatment. The manufacture of Pieris' first clinical test candidate was the first successful industrial-scale use of our secretion system for such a drug.

Our white-biotech research focuses on the development of products based on renewable substances. In 2008, we succeeded in producing high yields of the amino acid cysteine via fermentation and in isolating it directly from the fermentation broth. For the first time, vegetarian-grade cysteine had been obtained by totally natural means. We plan to launch cysteine onto the aroma market during 2009. What's more, we are trying to replace ever-scarcer petroleum and natural gas with renewable substances. For instance, our researchers are devising a way to obtain acetic acid and ethylene from biomass and bioethanol.

To promote in-house research, WACKER annually confers its Alexander Wacker Innovation Award. 2008's award was for basic research and went to the developers of α -silane technology. With α -silanes, it is possible to make high-performance and low-environmental-impact construction products – for instance, isocyanate-free, α -silane-based installation foams to replace conventional polyurethane ones. Isocyanates may cause allergies and some are suspected of being carcinogenic. As a result, there is a new, stricter EU regulation governing the marketing and use of isocyanate-containing products.

Another type of silane – vinylsilane – improves the properties of traditional thermoplastics such as polyethylene. Being susceptible to temperature and the weather, thermoplastics are unsuitable for a wide range of pipeline and cable applications. As it is more resistant, silane-crosslinked polyethylene can open up these applications, where PVC had previously held sway.

Procurement

WACKER's total procurement volume is broken down into raw materials, other services, and investments. The volume of raw materials and other services was €1.89 billion in 2008. The level of investments procured amounted to €767 million. The procurement rate – the procurement volume for raw materials, other services and investments in relation to sales – was 61.8% (2007: 60.6%). Some 1,300 different raw materials and numerous technical goods and services were purchased last year for plant-engineering and maintenance-related purposes.

Procurement Volume

(Including Procurement for Capital Expenditures)

€ million	2008	2007
Procurement volume	2,660	2,291

To boost efficiency and effectiveness, WACKER reorganized its procurement processes in 2008. The measure was prompted by two developments. On the one hand, raw materials procurement was becoming increasingly important, given the huge volumes and widely fluctuating prices. On the other hand, WACKER's large-scale investment projects in Germany and abroad necessitate an even greater emphasis on what we procure. That is why we made raw materials procurement into a separate corporate department and increased staff numbers there. Our existing Technical Procurement & Logistics department is responsible for the purchasing of technical goods and services and the related logistical aspects.

New Procurement Organization Improves Purchasing Processes

We globally coordinate the procurement of our eight key raw materials (e.g. silicon, methanol and ethylene), while decentralizing operational responsibility, devolving it to WACKER's subsidiaries. By reorganizing raw materials procurement, we aim to bolster procurement reliability, optimize our terms of purchase, improve supplier relations and further intensify our activities on raw materials markets.

As for technical procurement, we set up our own project procurement unit to prepare ourselves for new challenges. Centers of expertise tackle such fields as contract management and electronic procurement/processes. Together with logistics, as well as the purchasing of materials and services, these fields are the responsibility of our Technical Procurement & Logistics department.

WACKER centrally manages supplier contracts, quality assurance, procurement-process enhancement, support of global suppliers and all procurement-related processes for technical goods and services. Materials-delivery scheduling and dispatch are handled regionally or locally. This boosts the reliability of local supplies and optimizes local deliveries. With capital expenditures up in 2008, there were more procurement transactions for the construction of new plants. The handling of such large-scale projects hinges not only on price/quantity negotiations, but also on fixing deadlines with contractors. The whole process occurs in close collaboration with Corporate Engineering.

Organization of Procurement

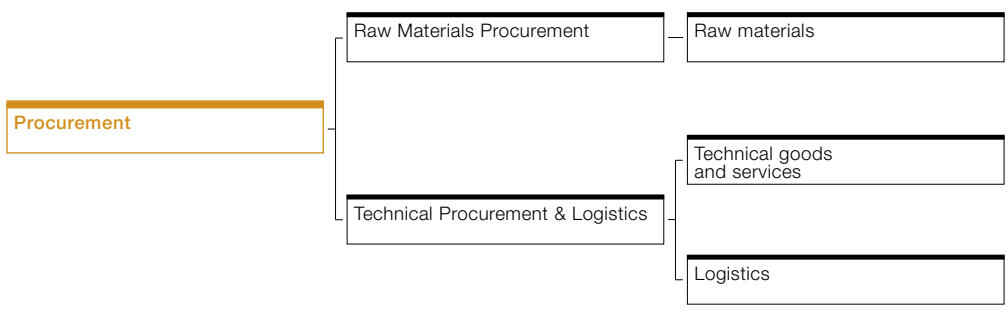

Our integrated procurement system's aim is to ensure worldwide product availability for customers. We run all procurement processes via our Group's SAP IT system – supplemented by our custom data-processing programs, preferably linked to SAP. Our homogeneous IT infrastructure benefits transparency. At all times, our procurement management system provides detailed data on each purchasing transaction. APP's integration into WACKER in 2008 means that SAP now covers APP procurement processes, too.

To supply customers even faster and more reliably worldwide, we expanded Burghausen's Container and Logistics Center. WACKER invested a total of €18 million in this expansion project. A second fully automated high-bay warehouse increased the center's overall capacity from 11,000 to 19,000 pallets. The clear separation between incoming products (from production plants) and outgoing ones to be shipped to customers make warehousing processes much more efficient. Expansion of Burghausen's logistics hub was rounded out when Loxxess opened an external warehouse there. As a result, ten external, previously separate warehouses could be concentrated at a single site.

WACKER has signed long-term agreements with many logistics providers and regularly puts most of its services out to tender. Where appropriate and necessary, we negotiate multi-year contracts. Contracts for sea/air freight, couriers and road/rail transport are awarded and managed globally. Their day-to-day operations are global, too, except in the case of road and rail transport, which is handled decentrally. To reduce road-transport and environmental impact, most of the containers leaving WACKER's German sites are exported via rail – totaling over 20,000 freight containers per year.

In 2008, the importance of electronic order processing continued to grow, accounting for some 60% of our orders (2007: 55%). For some major raw material suppliers, we use channels such as ELEMICA (the chemical industry's e-commerce platform) and SAP's Supplier Self-Services feature. What's more, we currently use over 80 different e-catalogs.

Electronic Orders
Continue to Grow

Procurement uses its own e-auctionhouse platform to handle online auctions and requests for bids. E-business solutions streamline our supplier transactions. In Germany alone, we process around 19,000 order items electronically every month. This frees up more time for large-scale and complex procurement transactions. Standardized and automated data transfer has many other advantages. It saves costs, enhances data quality and thus reduces error sources. Plus, transactions are faster, more accurate and reliable.

Production

WACKER's integrated production systems, primarily based on silicon and ethylene as starting materials, are one of its greatest strengths. We have highly integrated and interlinked production processes along the entire supply chain. Our internal systems function as loops. In our processes, we optimize the number of materials used – combining, processing and recycling them. By-products are usually further processed immediately or used in another production area. Take, for example, our integrated silicon production system. Although it comprises just four starting materials – silicon, methanol, hydrogen and salt (sodium chloride) – it enables us to manufacture over 3,000 silicone products, as well as pyrogenic silica and polysilicon. And in our integrated ethylene production system, we generate acetaldehyde, acetic acid, ketene, vinyl acetate, polymer dispersions and dispersible polymer powders. This unique production strategy conserves resources and energy, and ensures seamless monitoring and control for our customers throughout the entire material loop – from the raw material to the finished product.

WACKER's Highly-Integrated Production System Is Efficient and Clean

WACKER has three integrated sites worldwide. The cornerstone of our integrated-site policy is Burghausen, our largest production site. WACKER also maintains production sites in the key sales regions of Europe, the Americas and Asia. Our strategy is to manufacture goods as close to our customers as possible to maximize the speed of delivery. Additionally, this strategy makes us less prone to exchange-rate fluctuations. Transaction risks are lower, because production costs and sales revenue are in the same currency. A further benefit is that we reduce our transport costs and risks.

Over the past years, WACKER's production network has expanded enormously, due to rising sales volumes and the growth of our production operation in China – currently the main growth market. WACKER has not only invested in new production sites, but also expanded or acquired existing plants.

Capital Expenditures

Site	Project	New Capacity	Commissioned
Burghausen	Poly 5	650 t/a granular polysilicon	2008
	Poly 7	4,500 t/a polysilicon	2008
Jena	Solar wafer production	50 MW/a solar wafers	2008
Singapore	SSW	300 kW/m after full ramp-up	2008
Zhangjiagang	Pyrogenic silica (HDK®)	10,000 t/a	2008
	Silicone emulsions		2008

Production network expansion has been complemented by our “Wacker Operating System” (WOS) program. WOS aims to continually optimize the productivity of WACKER plants. So far, the program has been instrumental in significantly boosting our productivity around the world since its introduction at Burghausen in 2004. WOS focuses on lowering not only specific operating costs, but also raw material and logistics costs. On the raw material side, the program is concerned with either achieving higher yields or reducing raw material consumption. In logistics, WACKER is working toward lower transport costs and optimized delivery times.

Plant Productivity
Continues to Rise

Employees

The number of employees at WACKER grew in 2008. On the reporting date (December 31, 2008), the Group had 15,922 employees worldwide (December 31, 2007: 15,044), up 5.8% year on year. This increase is primarily due to polysilicon-production expansion at our Burghausen site, strategic expansion projects in China and integration of former APP employees. Personnel expenses also rose to €1.09 billion (2007: €1.01 billion), up 7.0% year on year. These expenses included outlays for social benefits and the company pension plan amounting to €220.8 million (2007: €190.3 million).

Personnel Expenses

€ million	2008	2007	2006	2005	2004
Group	1,086.1	1,014.9	962.4	867.8	881.8

In addition to their fixed base salary (which includes vacation and Christmas bonuses), WACKER employees receive variable compensation – a voluntary bonus to both pay-scale and above-pay-scale employees. It consists of profit-sharing and a salary component based on personal performance. For 2008, the profit share for domestic employees at WACKER’s chemical divisions equaled 12.5% of their annual salary.

The German chemical employer association (BAVC) and the mining, chemical and energy industrial union (IG BCE) agreed on a new collective-bargaining package in April 2008. The package is valid until 2010 and has a total duration of 25 months. The first stage entailed salary increases of 4.4% effective April 1, 2008. In addition, employees received a one-off payment of 0.5%. In the second stage, which runs 12 months, salaries will increase 3.3% effective May 1, 2009. Base salaries for above-pay-scale employees rose 4.3% effective July 1, 2008.

12,110 WACKER employees (76.1 %) work in Germany and 3,812 employees (23.9%) elsewhere in the world. Employee numbers in China – where we expanded production capacities for silicone and polymer products – grew by a notable 133. In Germany, employee numbers rose by 486, primarily due to capacity expansion at our WACKER POLYSILICON division. Some 350 former APP employees in Germany, the USA, South Korea and China were integrated into the WACKER Group.

Number of Employees on December 31, 2008

	2008	2007	2006	2005	2004
Germany	12,110	11,624	11,340	11,296	11,344
International	3,812	3,420	3,328	3,138	3,344
Group	15,922	15,044	14,668	14,434	14,688

Due to our divisions' production plants, WACKER has a large contingent of industrial employees (55.3%) – about a sixth of whom are women (14.8%).

WACKER has always prioritized vocational training. In fiscal 2008, 193 young people began their training at WACKER or at its Burghausen Vocational Training Center (BBiW). In total, the company employed 643 trainees (2007: 616), of whom 559 were in scientific and technical disciplines and 84 in business administration. Following the completion of their training, they have a good chance of receiving a permanent job. In 2008, we were able to offer all suitable and interested trainees a job. In total, 96 were kept on. Established by WACKER, the BBiW is a public foundation that also serves to train individuals from some 30 partner companies.

Number of
Trainees Grows
Once Again

To recruit young management talent, WACKER offers a General Trainee Program for university graduates. Currently, five graduates are participating in the 18-month program. Our Siltronic division has a separate trainee program. There, eight trainees are focusing on supply-chain management and production.

WACKER employees should never stop learning, and should continually expand their expertise. We seek to cultivate employees according to their strengths and career paths. Performance reviews, held at least once a year, afford employees and supervisors the

chance to agree on development measures. This approach applies to all employees, from standard pay scale up to top management. In 2008, over 65,000 e-learning sessions were completed and 10,200 participants took part in seminars, advanced training courses and conventions.

In addition to the advanced training offered to employees, personnel development also identifies and fosters young management potential for leadership responsibilities. This uniform process is conducted groupwide. In 2008, 15 junior employees with "Executive Personnel" potential completed their management training. 13 newly appointed executives took part in the "OFK Management Circle," a custom WACKER program on strategic management. In total, WACKER invested €7.2 million in personnel development and advanced training in 2008 (2007: €6.2 million).

In markets with strong competition, companies particularly profit from their employees' ideas and improvement suggestions. WACKER's idea management in 2008 posted a record number of suggestions and ideas submitted, generating its highest-ever calculable benefits. In all, 5,808 suggestions were submitted, a gain of over 30% (2007: 4,440). The calculable benefits in fiscal 2008 equaled €13.5 million (2007: €7.6 million).

WACKER's Idea Management Provides Calculable Benefits

Idea Management at WACKER

	2008	2007	2006	2005	2004
Number of improvement suggestions	5,808	4,440	3,816	3,105	3,284
Calculable benefit	€ million 13.5	7.6	3.8	2.5	2.3

WACKER's company pension fund is an important component of employee compensation. The fund covers all WACKER sites worldwide, except for regions where legal provisions are inadequate or the statutory pension appears sufficient. In Germany, WACKER offers its employees an attractive company pension plan via its Wacker Chemie VVaG pension fund, which was established in 1928. WACKER offers its employees an attractive company pension plan via its Wacker Chemie VVaG pension fund. The fund has some 15,800 members and provides pension payments to some 6,900 retirees. The average pension paid was around €630 per month. WACKER matches employees' annual pension contributions. In addition, employees have the opportunity to enlist in a private plan that minimizes their tax burden while saving for retirement. WACKER contributed an unplanned total of €55.0 million to domestic and international pension funds in fiscal 2008.

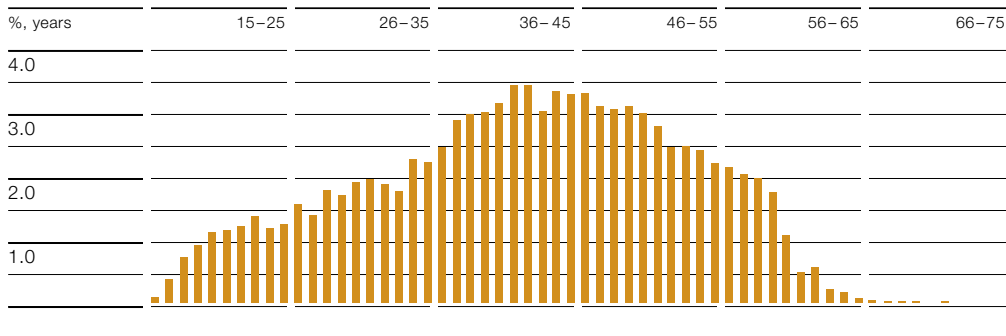
Average Age

WACKER has been addressing demographic change intensively since 2006. The average age of employees was 42.2 on the reporting date (permanent staff). We have specified ten goals to maintain our long-term innovative and competitive strength. Our measures range from employee health programs to basic and advanced training aimed at career flexibility. We want to remain attractive to current and future employees via our exemplary social benefits and performance-oriented compensation. Another goal is long-term employee retention. The fluctuation rate in 2008 was 2.9% groupwide, and in Germany just 0.9%. The average length of service is 16.8 years.

Job applicants are increasingly interested in measures to enable a work/family balance. In 2008, WACKER was one of the first companies to join Germany's "Family as a Success Factor" business network. A central platform for companies and associations, the network – a joint Federal Ministry of Family Affairs and German Chamber of Commerce (DIHK) initiative – is committed to a family-oriented management approach.

The success of WACKER's personnel policies was confirmed by external examinations in 2008. In an analysis by Germany's Association of Chemical-Industry Executives (VAA), we once again took a top spot by ranking third. Our Chinese subsidiary, WACKER Greater China, was voted "Top Employer 2008" in Greater Shanghai. Companies were rated on their leadership style, personnel-development programs, company goals and strategies. However, we are not resting on our laurels. In terms of personnel marketing, our strategy is to enhance recruiting efforts for applicants from fields vital to our success, such as engineers. In 2008, for example, WACKER held a summer course for process-engineering and chemical-engineering students to provide insight into engineering tasks at a chemical company.

Sustainability

At WACKER, sustainability has been an integral part of production and business processes for many years. We view this as the basis for our company's business success. Sustainable development means balancing economic, ecological and social factors in everything we do. WACKER nominated a specific Group coordinator in 2008 to further bolster the sustainability topic within the company. The coordinator supports and advises WACKER divisions and corporate departments in their sustainability efforts and helps ensure that our business partners throughout the supply chain also comply with recognized work and social standards, and commit themselves to responsible environmental action.

Beside Responsible Care®, the global chemical industry initiative, WACKER has also joined the UN's Global Compact. We voluntarily implement its ten principles in the areas of human rights and social and environmental standards. In 2008, we requested that our suppliers also support this obligation. Our supplier management system adheres to this voluntary commitment, and we evaluate our suppliers' adherence annually.

Sustainability
Vital for Business
Success

Environmental Indicators in 2008

Air	
CO ₂ emissions	976,041 t
NO _x nitrogen oxides	997 t
Water	
Water consumption	241,286,375 m ³
Chemical oxygen demand (COD)	4,782 t
AOX halogenated organic hydrocarbons	7 t
Waste	
Disposed of	87,293 t
Recycled	74,327 t
Hazardous	108,458 t
Non-hazardous	53,161 t
Energy	
Consumption	2.4 TWh
Primary energy	
Natural gas	5.4 TWh
Heat (supplied by third parties) ¹	0.2 TWh
Heating oil	0.01 TWh

¹ Steam, district heating

Environmental Protection

Environmental protection is a core component of all processes at WACKER. The focus is not so much on remedial measures, but rather begins as early as the product-development and plant-planning stages. A good example of this is the production of L-cysteine, an amino acid. This is used in drugs, cosmetics and food. Previously, this amino acid was mainly produced via extraction from hair, feathers and pig bristles using hydrochloric acid. With its bacterial fermentation, WACKER has developed a biotech process that can reduce the use of hydrochloric acid by a factor of 27. As a result, WACKER was awarded the Federation of German Industry (BDI) 2008 Environmental Prize.

In terms of production, WACKER succeeded in developing a process to recycle pyrogenic silica at its Nünchritz site. Previously, silica dust at the residue incinerator was land-filled. Thanks to the new process, some 1,000 metric tons can be recycled annually and used as an additive.

Groupwide, WACKER produced 161,619 metric tons of waste in 2008. Some 46% of this was able to be used as material and energy. The rest had to be disposed of. 108,458 metric tons were classified as hazardous and 53,161 as non-hazardous waste. WACKER continually strives to close its material loops, redirect by-products to other production areas and thus to prevent and reduce waste.

Energy Management

In 2008, higher production volumes increased WACKER's electricity consumption to 2.4 million MWh (2007: 2.1 million MWh). At its Burghausen site, the Group's own gas and steam cogeneration power plant and hydro-power plant, as well as Nünchritz's own cogeneration plant produced 1.4 million MWh. This means that WACKER produced just under 60% of its total electricity needs itself.

In 2008, the second European emissions trading period began. WACKER participates in trading with its Burghausen and Nünchritz site power plants. The necessary emissions certificates were allotted to us free-of-charge for the 2008-2012 period.

CO₂ emissions, of which 82% resulted from energy-generation plants subject to emissions trading amounted to 976,041 metric tons groupwide. In 2007, WACKER initiated its Power Plus energy efficiency project for the Burghausen and Nünchritz sites. The goal is a 10% reduction in specific energy consumption at the two sites by late 2009 (base year: 2006). All energy-intensive facilities there have been examined and energy-saving measures developed. We are also working on boosting energy efficiency at our international sites. Siltronic's Portland (Oregon, USA) site equipped its cooling-water supply with higher performance cooling pump units and a heat recovery system. As a result, power consumption was cut by 1 million kWh and natural gas demand by around 25% per year.

Due to production increases and full consolidation of sites acquired from Air Products, heat consumption rose to 2.8 million MWh groupwide (2007: 2.5 million MWh).

Workplace and Plant Safety

Workplace and plant safety is a key priority at WACKER. It forms the basis for disturbance-free production. Systematic work safety at WACKER includes the regular evaluation of hazards and work-area monitoring. A comprehensive health-protection program serves to maintain and promote our employees' performance levels.

We conduct extensive safety and risk analyses from the design stage through to commissioning to ensure our plants' safety. This takes place according to a two-stage system. In stage one, experts model possible damage events, such as an explosion or chemical leakage. Subsequently, potential causes are determined and preventive measures developed. This danger-scope analysis is followed by stage two, in which we particularly examine critical plant components for potential error sources. Resultant risks are then evaluated according to their effect, the probability of persons in the danger zone, estimated probability of occurrence and possibilities of timely emergency response. We then assess the quality of each protective measure proposed for the risk class in question. WACKER places particular importance on the basic and advanced training of its safety experts worldwide. We regularly conduct seminars on plant safety, explosion protection and occupational health and safety.

WACKER continued and extended its "Fresh Impetus for Work Safety" initiative. Launched in 2007, this initiative serves to prevent workplace accidents. Executives in Germany received workplace-related safety training last year. With the help of poster campaigns, videos, articles in employee media and interactive stage productions, employees were informed about safe workplace behavior to further reduce our already low accident figures.

Groupwide, there were 3.7 workplace accidents in 2008 (2007: 3.8) per 1 million hours worked. For comparison: the insurance association of the German chemical industry (BG Chemie) lists an average of 9.4 accidents per 1 million hours worked in 2007.

Number of Accidents per Hour Worked Continues to Fall

In fall 2008, setup work commenced on the SAFE storm research project at the Burghausen site. SAFE serves to provide earlier forecasts for storms, given their greater frequency and intensity due to climate change, and to initiate emergency-response measures. Environmental sensors are used and are interlinked with existing weather stations and warning systems. WACKER's Burghausen site is the sole industrial site participating in this project, which is sponsored by the German Federal Ministry of Research.

Transport Safety

In collaboration with logistics providers, WACKER makes sure that hazardous-goods vehicles are checked prior to loading and those with deficiencies rejected. Deficiencies are systematically tracked and recorded. We use this as a basis for agreements on transport-safety improvement measures. Every two years, WACKER audits hazardous goods shippers. Aside from the legally-stipulated monitoring of hazardous-goods transport, WACKER also tracks the safe transport of non-hazardous goods.

WACKER's safety standards are above the minimum required for hazardous-goods transportation. Thus, we ship chlorosilanes to customers not by truck, but via rail, and in containers of the highest safety classification.

To evaluate shippers, WACKER uses the Safety and Quality Assessment System (SQAS) of the European chemical association (CEFIC). The goal is to have independent experts evaluate logistics providers uniformly. Criteria include shipping employees' training, vehicle equipment and accident response. The results are available to all SQAS service-group members.

Product Responsibility

WACKER ensures that its products, if used properly, pose no risk to humans or the environment. Product information is always up to date and any new findings are immediately reflected in risk assessments. We currently compile material safety data sheets for all our sales products regardless of legal provisions. In total, over 50,000 material safety data sheets are available from WACKER in up to 28 languages.

EU-wide REACH legislation took effect in June 2007. It governs the registration, evaluation, authorization and restriction of chemicals within member states. We have been preparing for REACH requirements since the European Commission issued its white paper on chemicals policy in 2001. REACH requires more information about chemical products' properties. This necessitates an increase in legally-stipulated animal testing. WACKER makes every effort to avoid animal testing and only performs ECHA-approved tests. In doing so, we use recognized alternative methods such as in-vitro tests and bundle materials with the same modes of action for group testing.

Products for Climate Protection

WACKER not only undertakes a great deal internally to ensure that production is environmentally compatible, but also makes an important contribution to energy efficiency and climate protection with a myriad of products. One example is VINNAPAS® dispersible polymer powder. VINNAPAS® helps insulate buildings against heat and cold – reducing energy costs by as much as 60%.

As one of the largest producers of hyperpure polycrystalline silicon, we supply the solar industry and thereby contribute to the increasing use of renewable and environmentally-compatible energy sources. Each metric ton of polysilicon used in solar modules prevents the emission of some 2,500 metric tons of CO₂.

Social Commitment

WACKER supports scientific, social and cultural projects, primarily through regional and local outreach programs at our sites. In doing so, we focus on education and science. In 2008, WACKER once again assumed sponsorship of the Bavarian state's "Young Scientist" competition, as well as of the regional competition in Dresden. For years, we have been supporting young scientific talent and motivating young people to research and discover.

In July 2008, WACKER and the Technical University of Munich (TUM) opened an Institute of Silicon Chemistry in Garching near Munich. In total, we provide €6 million, thereby fully funding the new institute for at least six years. The 500 m² laboratory wing provides ideal working conditions for interdisciplinary research into macromolecular organosilicon compounds. Under the direction of the WACKER Chair of Macromolecular Chemistry, the institute concentrates on such research fields as organofunctional silicon compounds and silicones. Funding primarily targets projects at the crossroads between physics, biotechnology and the material sciences.

Aside from education and science, we are also particularly active in social projects for children and young people. Since 2007, WACKER has been supporting a German religious charity, "Die Arche." The charity mainly helps five- to twelve-year-olds from socially disadvantaged families in several German cities. It provides the children with hot meals and tutoring, organizes leisure activities and offers advice and counseling. In 2008, WACKER donated €100,000 to this charity. The Munich branch is using this money to enhance its youth work via additional rooms and a new social worker.

WACKER's relief fund (WACKER HILFSFONDS) was set up in 2005 to offer aid to victims of catastrophes. In May 2008, news of the earthquake in the Chinese region of Sichuan shocked the world. The Executive Board donated €50,000 to the relief fund as emergency aid and matched the sum donated by employees for the earthquake victims. In total, donations of €100,000 were collected. Together with our WACKER Greater China subsidiary, the relief fund decided to use the money to rebuild a school in the Sichuan region.

The goal of risk management at WACKER is to identify risks as early as possible, to evaluate them appropriately, and – if necessary – to eliminate them using suitable measures. As a specialty-chemical and semiconductor company, we have a particular responsibility in operating our plants and protecting health and the environment. This is why all our production sites have employees dedicated to plant and workplace safety, as well as health and environmental protection. Our risk management complies with German legislation on control and transparency in companies (“KonTraG”) and is a key component in all our decisions and business processes.

The WACKER Group is regularly faced with risks and opportunities which could either negatively or positively affect its assets, earnings and cash flow, as well as its intangible assets such as its trademarks or image.

In order to make risks as manageable as possible, WACKER focuses on identifying, evaluating, controlling and monitoring them. Thus, risk management is a groupwide task involving all corporate levels. WACKER’s risk management system consists of three intermeshed aspects:

- Area-specific risk management, including corresponding early-warning systems
- Groupwide risk coverage
- Groupwide risk mapping

Risk Management System

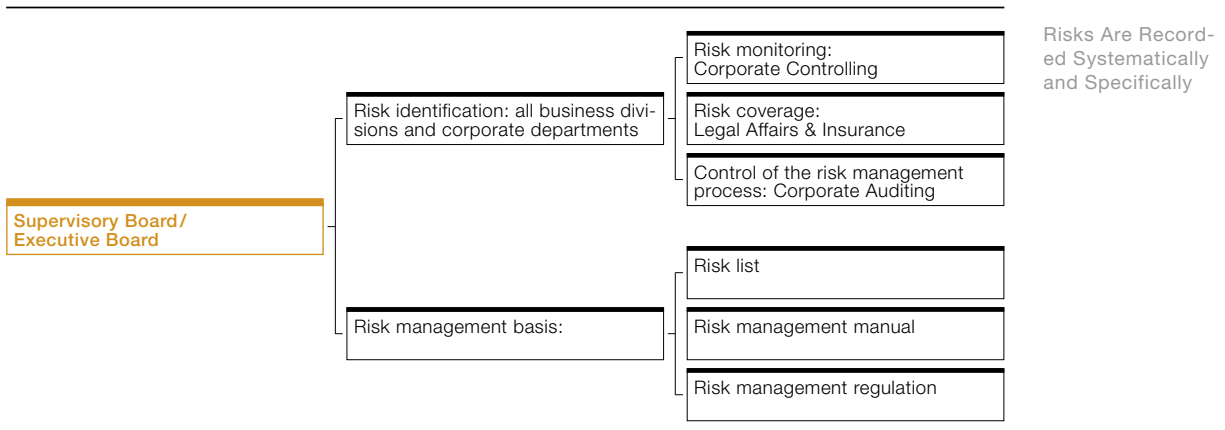

Organization and Tools

WACKER continually surveys both the overall economic situation and industry-specific developments to identify risks as early as possible. WACKER has a riskmanagement manual that specifies risk management principles, processes and reportable levels of risks. The

manual also describes how risks are to be covered and mapped. The WACKER Group Risk Management regulation governs, for example, reporting requirements and when a specific committee must be informed. WACKER revised this regulation in 2008. Specific individual risks facing the corporate units and business divisions are compiled in a risk list.

Identified risks are assessed according to their probability of occurrence and their potential affect on earnings. We employ various tools for the early detection and identification of risks. The Executive Board is informed of current and future business developments via monthly reports by the Corporate Controlling department. We evaluate and compare strategic opportunities and risks at regular meetings with our divisions. These meetings also serve as venues for communicating groupwide risks and discussing possible solutions.

WACKER's Corporate Controlling ensures that our risk management standards are put into practice. It is responsible for the ongoing development of the risk management process, and the groupwide compiling of all substantial risks and their systematic evaluation according to uniform criteria. As the divisions are responsible for their own results, risk management is closely interwoven with the process of operational controlling. Operational risk management is thus anchored in these entities. To the same extent, Corporate Finance, Raw Materials Procurement, Technical Procurement & Logistics and Legal & Insurance are integrated in risk controlling at the Group level.

Corporate Finance is in charge of managing financial risks. All exchange-rate and interest-hedging transactions are concentrated in this area. Detailed stipulations and regulations, covering the functional separation of trading and settlement, among other things, mandate the scope of action. Receivables management vis-à-vis customers and suppliers is monitored by Corporate Accounting.

Internal Control System

Corporate Auditing regularly inspects, on behalf of the Executive Board, the correct functioning of risk management systems at all business divisions, corporate departments and subsidiaries. WACKER's uniform control mechanisms – such as its dual-control policy and separation of functions – are fully established and apply as standards groupwide. Audits focus on correctness, compliance, safety/security and cost efficiency. Topics and items for auditing are determined annually in a risk-oriented procedure. We react flexibly to altered auditing requirements. Auditing teams usually consist of one to three employees, depending on the item and auditing scope. In 2008, Corporate Auditing conducted 30 audits.

External Control System

Externally, the risk management system is examined by the auditors as part of auditing annual financial statements.

Overall Economic Risks

The global credit crunch, triggered by the US housing-market crisis, impacted global economic growth in the second half of 2008. As in fiscal 2007, we were once again faced with major challenges such as high energy and raw material prices, as well as exchange-rate imbalances. WACKER countered these with productivity and product-price increases. For 2009, we are expecting a global recession, which will affect sales and results. From today's viewpoint, it is not possible to predict how long the recession will last and how serious it will be. As early as the second half of 2008, some raw material prices fell and the dollar gained against the euro. If these trends continue in 2009, they may reduce our costs as a result.

Sales-Market Risks

Due to the overall economic climate, demand growth was weaker in key sales sectors – primarily construction and semiconductors. Since WACKER serves many different sales sectors, we were able to partially compensate for weakness in these two particular areas. WACKER's goal is to expand the share of resilient product sectors in its portfolio and to rank among the global leaders in every area of activity. Through close collaborations with customers, we aim to develop novel applications at an early stage, thereby retaining them as long-term customers.

Procurement-Market Risks

As a chemical and semiconductor manufacturer, we are subject to risks associated with shifts in the availability and prices of raw materials and energy, as well as starting materials and intermediates. In some areas, we rely on only one supplier for the procurement of production equipment. To make procurement (particularly of raw materials) even more efficient, WACKER reorganized its raw material procurement in 2008. The most important raw materials for our business are subject to a regular risk review. Their reliable supply is risk management's utmost priority. Furthermore, we attempt to counter procurement risks via a whole series of measures. These include long-term supply agreements with partners of high creditworthiness, centrally negotiated procurement agreements, and multiple suppliers for any one product. In the case of long-term agreements with fixed purchase obligations, Raw Materials Procurement aims to keep purchase quantities as flexible as possible.

→ See further details on page 86

Financial Risks

Financial risks primarily stem from trade receivables and Group financing, as well as currency, interest-rate and price shifts. Various WACKER departments are responsible for controlling and monitoring these risks. A detailed policy on dealing with financial risks has long been in use. We use original and derivative financial instruments to cover and control important financial needs and risks resulting from our operations. The use of financial instruments that are not based on actual or planned operational business is prohibited.

Policy on Dealing
with Financial
Risks Is Defined in
Detail

WACKER minimizes risks stemming from trade receivables by demanding collateral (e.g. retention of title) depending on the nature and extent of the service provided. Preventive measures also include references and credit checks, as well as the evaluation of historical data from our business relationship to date (particularly payment behavior). Moreover, we take out credit insurance to minimize risks.

WACKER is exposed to currency, interest and pricing risks. The Group uses derivative financial instruments such as forward contracts to hedge against these risks. Among the derivatives we use are, in particular, currency-option and foreign-exchange contracts and foreign-exchange swaps. Foreign-exchange hedging is performed predominantly for the US dollar, the Japanese yen and the Singapore dollar. Interest-rate hedging is performed predominantly for the euro and the US dollar.

Derivatives expose WACKER to credit risks arising from non-performance by contracting partners. For this reason, business is only conducted with financially sound banks and partners. These transactions are governed by internal corporate procedures that stipulate separation of trading and processing. Processing is subject to stringent controls.

Financing and liquidity risks are likewise managed by our Corporate Finance department. Funding for our joint ventures is also managed centrally. WACKER's credit lines are sufficient. The same applies to its cash and cash equivalents, which amounted to €305.3 million as per the reporting date. At the same time unused credit lines of some €800 million were granted. In fiscal 2008, WACKER increased net financial liabilities by €115.8 million. We consider the probability of these risks actually occurring to be low. → See further details on page 71

The vast majority of the Group's pension guarantees are covered by the WACKER pension fund, pension-related funds, special-purpose assets and insurance plans. The largest share thereof is accounted for by the Wacker Chemie VVaG pension fund. This fund manages the pension insurance of WACKER's German-based employees in accordance with its Articles of Incorporation and General Terms and Conditions of Insurance. The pension fund's investments are generally exposed to general capital-market risks. These risks are

limited via diversification into various different investment vehicles and, if necessary, through additional hedging measures. Sufficient coverage of pension obligations is ensured by way of WACKER financial payments as needed. WACKER's unplanned financial payments to domestic and international pension funds amounted to €55.0 million in fiscal 2008.

Risk of Damage

WACKER's production facilities meet high technical and safety standards. However, operating malfunctions cannot be ruled out. Issues such as environmental protection, plant/workplace safety, and employee health are vital and firmly anchored in our business ethos. WACKER has globally binding principles, regulations and monitoring instruments. Aside from appropriate insurance coverage, we have developed emergency-response plans that are regularly reviewed and practiced in training exercises. Via extensive maintenance monitoring and ongoing inspection, we try to ensure the highest possible level of operational safety at our production sites. → See further details on page 89, 96

Emission Allowances

To improve climate protection, many countries want to limit emissions from energy-intensive industries – particularly CO₂ emissions. The EU intends to reach this goal by granting emission allowances to relevant industrial companies and the energy sector. WACKER is affected at its Burghausen and Nünchritz sites in Germany. CO₂ certificates were issued for the 2008 to 2012 period. WACKER has not experienced any negative emissions-trading effects to date. We have installed an early warning system that enables us to react quickly if our emission allowances should not suffice.

Legal Risks

To counter legal risks arising from a wide variety of tax, trade, anti-trust and environmental laws and regulations, we base our decisions on centralized contract management and extensive legal counsel. In many cases, we seek external legal advice. Patents, trademarks and licenses are monitored and protected by the Intellectual Property department. By reviewing patent regulations, we intend to determine – prior to initiating R&D projects – to what extent existing third-party patents and intellectual property rights could impair competitive marketing of any newly developed products, technologies or processes. We currently know of no potential risks that could arise from patent infringements. An antitrust action in the context of possible price-fixing agreements for road salt is currently pending against Wacker Chemie AG and other companies. The Bundeskartellamt (German federal cartel office) issued anti-trust fines in summer 2008. Since Wacker Chemie AG cooperated with the relevant authorities, it was not affected by anti-trust penalties.

Legal Risks Are Limited via Centralized Contract Management

As a global company, we are totally committed to observing and acting in accordance with the laws, statutes and ethics of the various countries in which we are active. WACKER's Code of Conduct defines and stipulates binding rules of behavior for all employees. Via employee training, we enhance awareness of these issues and attempt to prevent reputation-related risks.

IT Risks

Failure of IT systems or a major loss of key data could substantially impair WACKER's operations. We use state-of-the-art hardware and software to prevent IT downtime and the loss or manipulation of data, as well as unauthorized access to our IT network. IT security and risk management is responsible for handling hazards in a cost-efficient way. This task is based on ISO Standard 27001. Using a risk analysis, we define our central systems' requirements in terms of their availability, as well as the confidentiality and integrity of the data. The requirements are anchored in service level agreements (SLAs) that we conclude jointly with our divisions and corporate departments. Compliance therewith is continually monitored and controlled to immediately initiate countermeasures for disturbances.

We set – and exceeded – an availability goal for our central ERP systems (Enterprise Resource Planning) of 99.5% for 2008. We primarily achieved this by having our systems designed with maximum availability and installing associated backup and recovery procedures. Moreover, we took appropriate steps to prepare for an emergency (Business Continuity Management).

We minimize project-related IT risks via a uniform project-management methodology. In doing so, we ensure that risks are identified early on and that changes flow into our system landscape in a controlled manner. We also check our systems at regular intervals (internal and external audits).

Due to the extensive integration of IT in all corporate processes, prolonged downtime of our central IT systems would have a major effect on Wacker Chemie AG's financial position. However, thanks to our precautionary measures, we classify the probability of long-term downtime and the associated risks as being low.

Personnel-Related Risks

WACKER relies on highly qualified employees, whose performance is vital to WACKER's future growth and success. We compete with other companies for highly-qualified technical and management staff – in the face of a simultaneous decline in qualified applicants. To reduce the risk of failing to identify, hire and retain suitable employees, we take various measures to boost our attractiveness as a potential employer. WACKER has always strongly emphasized employee retention via a myriad of training activities, exemplary benefits and performance-oriented compensation. Further advantages include a wide range of working-hour policies and models, as well as opportunities to foster a work/family balance.

Evaluation of Overall Risk

According to all currently available information, we are not aware of any existential risks that endanger the WACKER Group's continuance in the foreseeable future.

During the first two months of 2009, WACKER took important steps as part of its multi-year financing strategy.

We are negotiating a syndicated, three-year, €150 million credit facility. It is intended to prematurely replace an existing syndicated €100 million credit facility due in late 2009. Negotiations are at an advanced stage and, based on our current knowledge, are expected to be finalized in March 2009.

Our strategic financial measures include two further credit facilities totaling €110 million. WACKER was already able to conclude a credit line until 2012 with KfW IPEX-Bank (a German-government-owned development bank). We are in the process of negotiating with Bavaria's LfA development bank to receive follow-up financing until 2013.

Additionally, we are negotiating the conclusion of project financing for our polysilicon investments in Nünchritz (Germany).

CH4 ...// Management Report ...// Opportunities and Outlook

WACKER sees good opportunities for emerging stronger from the global financial crisis. Extensive details are outlined under "Opportunities and Outlook."

109

Opportunities
and Outlook

CH4

SILTRONIC ...//



Perfect Image Quality

...// Hyperpure silicon wafers are the basis of microchips – which lie behind numerous modern technical communication and IT developments. Innovative flatscreen monitors rely on silicon-based semiconductors. Siltronic is a global leader in the hyperpure silicon wafer market and a partner to all top-tier chip manufacturers.

Positioning of the Group for the Next Two Fiscal Years

Regardless of the currently difficult economic situation worldwide, WACKER's products, global presence, high level of production and plant expertise, employees and seasoned customer relationships represent strengths that will continue to ensure the company's long-term success in the future. This is why we currently do not foresee any major changes in business policies and organizational orientation. We expect that our business will become even more international than in years past and that we will expand our production, sales and service network. Today, WACKER is already a globally active company with a strong position in its European home market.

Opportunities

WACKER's product portfolio outstandingly serves key megatrends. Thanks to our strong international positioning, we see good opportunities to boost our market share in tomorrow's key growth regions over the coming years. In the medium term, WACKER expects to further boost its sales and profitability. In many business fields, WACKER has a technological edge that it intends to extend.

WACKER's Product Portfolio Outstandingly Serves Key Megatrends

WACKER's position enables us to consider and utilize opportunities in all Group areas. Our individual divisions directly act upon opportunities resulting from our operations. Wacker Chemie AG provides the strategic scope and ensures financing and liquidity. The individual plans flow into the Group's strategic planning process.

Opportunities at All Divisions

Despite the difficult global economic situation, WACKER has opportunities for further growth in many fields. We see key megatrends, from which we will profit in the future.

We serve the energy megatrend with a whole series of products. The largest growth opportunities still stem from our production of polysilicon for the solar industry. Until now, photovoltaics represents just 0.1 % of global energy consumption. Finite fossil fuels such as oil and the increasing importance of climate protection will accelerate the use of renewable energy sources. Sinking costs for photovoltaic systems and higher efficiency ratios are making solar electricity increasingly competitive. WACKER POLYSILICON provides the key starting material for this, namely crystalline polysilicon. With its innovative products in areas such as thermal insulation, WACKER POLYMERS makes a major contribution to saving energy and cutting greenhouse-gas emissions. The energy megatrend is also being driven by customers and consumers. Today, awareness of climate change and the environment is growing. This is why demand for environmentally-compatible products is rising. We are convinced that energy will greatly gain in importance in the years to come.

We serve the digitization megatrend by making silicon wafers for the semiconductor industry. The increasing digitization of products and ever greater silicon demand for consumer electronics are driving volume growth. Additionally, this development is fueled by strong Asian growth that would not be possible without digitization and the build-up of infrastructure. The share of 300 mm wafers in the semiconductor industry will show particularly strong growth. Through Siltronic, we profit from this high demand via the establishment and expansion of our 300 mm capacities in Burghausen and Freiberg, as well as in Singapore, where we are establishing a 300 mm wafer fab together with Samsung.

WACKER has numerous products that will be of vital importance for further development in the Asian growth region, as well as in emerging markets around the world. Our strong presence in these markets means we are well prepared to participate in growth there. In almost all sectors, we offer products and solutions that boost the region's living standards and promote its urbanization, infrastructural expansion, as well as environmental protection. Particularly at our WACKER SILICONES division, we have a diverse product range to boost living standards in emerging markets.

WACKER also has growth opportunities through production-capacity expansion. We invested €826.4 million in 2008 alone. For all our production facilities, meeting the highest productivity demands in a competitive environment is vital. With the help of our "Wacker Operating System" (WOS) program, we see opportunities to further boost productivity.

→ See further details from page 90

WACKER POLYMERS is opening up additional growth opportunities by expanding its supply chains. After acquiring full ownership of Air Products Polymers (APP) and Wacker Polymer Systems (WPS) – former partner companies with Air Products – WACKER is now the only company in the market that can cover the entire dispersion and powder production supply chain for the construction industry in Asia, Europe and the USA.

We also broadened the supply chain at WACKER POLYSILICON. WACKER SCHOTT Solar GmbH, our joint venture with SCHOTT Solar, is building a new solar-wafer production facility in Jena, Germany. By 2012, production capacity will have been extended step by step to 1 gigawatt. The joint venture with SCHOTT Solar boosts our share of value added during solar-cell and solar-system production and is expected to be one of the world's major solar-wafer manufacturers.

Lower energy and raw material costs, as well as more advantageous exchange-rate and interest-rate trends also offer opportunities for WACKER. Over the past two fiscal years, our business has been primarily impacted by continually rising energy and raw material costs, as well as the strong euro. Lower energy and raw material costs could have a positive effect on earnings.

Overview of Business Opportunities

External and Sector-Specific Opportunities	Strategic and Operational Opportunities	Financial Opportunities
Energy megatrend	Introduction of new products	More advantageous exchange rates
Digitization megatrend	Production capacity expansion	
Growth in Asia and other emerging markets	Higher plant productivity	
Lower energy and raw material costs	Supply-chain expansion	

Overall Economic Trends

Following six years of continuous growth, Europe and the USA will start 2009 in recession. In Asia, growth will slow significantly. Thus, the financial crisis is having a massive influence on the real economy. Analysts disagree as to how long the recession will last and how deep it will become. However, they are in agreement that this will be the most severe slump since the Great Depression of 1929. The International Monetary Fund (IMF) forecasts that the global economy will grow by just 0.5% in 2009 and a noticeable upturn will first materialize in 2010 – with growth of 3.0% then.

Global Recession
in 2009

The new American administration under President Barack Obama has started to counter the recession with a stimulus package of some \$800 billion. The package is aimed at infrastructure expansion and the health and education sectors. Consumer spending, the key pillar of the US economy, is weakening. Many households are heavily in debt and property values are declining. The unemployment rate is the highest in 14 years. According to many economic experts, the US economy is in a structural crisis that will usher in years of below-average growth rates. According to IMF estimates, the US economy will decline 1.6% in 2009 and rise 1.6% in 2010.

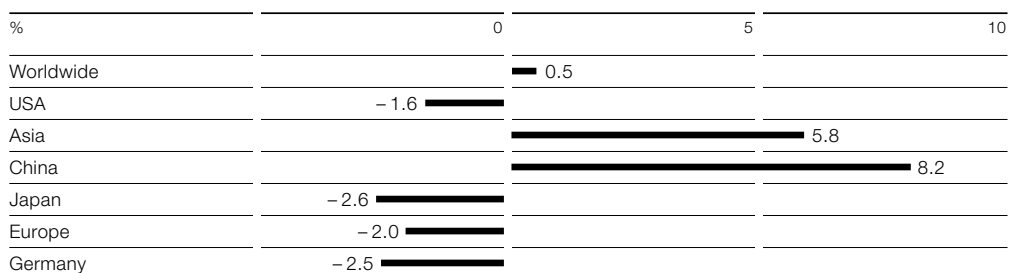
Gross Domestic Product Trends 2009

Sources: worldwide: IMF, USA: IMF, Asia: ADB, China: ADB, Japan: IMF, Europe: IMF, Germany: IMF

Although Asia will not enter into recession, growth there will slow significantly. The Asian Development Bank (ADB) sees inflationary dangers in the region despite weaker growth. The ADB forecasts growth of 5.8% in 2009. In China, the ADB expects a rise of 8.2%. The Chinese government is supporting growth via a US\$600 billion stimulus program. The money is intended to flow into housing, infrastructure and environmental projects. As with the USA and Europe, Japan will not escape recession. According to the IMF, the Japanese economy will decline 2.6% in 2009 and rise 0.6% in 2010.

As in the USA, Europe will enter recession in 2009. The IMF is forecasting a decline of 2.0% there. However, the economy is expected to grow 0.2% in 2010. The IMF foresees no growth for Germany in 2009 either, with GDP declining 2.5%. The forecast is reinforced by a strong drop in new orders for German industry. On the other hand, inflation is set to weaken substantially compared to 2008. For 2010, the IMF is expecting GDP growth of 0.1% due to government and central-bank financial aid.

General Sector-Specific Conditions

The semiconductor industry will decline in 2009. The Semiconductor Industry Association (SIA) forecasts a sales drop in that sector of 5.6% in 2009. The primary reason for this is weak demand for cellphones and personal computers, which currently account for 60% of sales. In its most recent analysis of the silicon-wafer market, Gartner Dataquest (a market research institute) is forecasting a drop in sales volumes and prices in 2009. According to Gartner, surface-area sold will drop 16% in 2009, but is expected to increase 14% in 2010.

The Swiss bank Sarasin is expecting photovoltaic-sector growth of 17%, thus weaker than in prior years. This is mainly due to the fact that the general situation has changed in Spain and Germany – two key markets. In 2009, feed-in payments in Germany are going to fall. In Spain, the installation of new solar modules was restricted to 500 MW per year. New solar parks account for 300 of this 500 MW, and roof modules for 200 MW. Installation of new photovoltaic capacity is set to rise to 4.8 GW in 2009. EPIA analysts are forecasting up to 5.2 GW of installed capacity. Polysilicon production will continue to rise in the years to come, since WACKER and other manufacturers are expanding their production capacities. How large this capacity increase will be is very difficult to estimate, since many projects have been announced in the past and then not always actually realized. Sarasin expects that the new polysilicon quantities will enable the production of 13.3 GW of c-Si-based solar cells in 2010. Average annual growth of 50% is forecast until 2012.

Installation of New PV Capacity in 2009 and 2010

	Installation of New PV Capacity (MW)		CAGR ¹ 09–10 %
	2010	2009	
Germany	2,247	1,873	20.0
Spain	460	600	-24.4
Other European countries	1,334	681	95.5
USA	1,363	681	100.1
Asia	1,226	729	68.2
Other regions	370	212	74.5
Total	7,000	4,776	46.4

Source: Sarasin Bank, November 2008; ¹CAGR: compound annual growth rate

The chemical industry will experience a weaker trend worldwide in 2009. According to the German chemical industry association (VCI), global chemical production will indeed grow – by 0.5% – though chemical companies in Europe, Japan and North America are nevertheless suffering from the weak industrial trend. According to the VCI, German chemical industry production in 2009 will decline 3.5% following four years of strong growth. Despite the dampened prospects, the chemical industry is expected to continue to grow in the years to come. This development will be primarily fueled by rising demand from key purchasing sectors in China. Chinese industry is expected to average 5% growth annually until 2015.

The construction-sector slowdown intensified due to the housing-market crisis. The weakness will be felt in all regions worldwide in 2009. Although slower, Asian growth will continue. In the established markets of the USA and Europe, the trend will range from subdued to declining. Global Insight, a market research institute, expects the construction industry to still grow 3.9% in 2009. In the medium term, we foresee a market recovery – due in part to infrastructure and renovation programs (thermal insulation).

According to German Electrical and Electronic Manufacturers' Association (ZVEI) estimates, only two areas will continue to grow in 2009: industrial electronics and automotive electronics. All other sectors, whether data equipment, consumer electronics or IT, will struggle with declining sales in 2009.

The WACKER Group's Prospects

We expect a significant economic downturn in 2009. Global GDP is anticipated to rise by less than 1%. Despite this figure, it is currently very difficult to estimate the effects of the financial crisis on the real economy, since various scenarios could occur. In light of this, no reliable and quantifiable forecast is possible for 2009 at this time. We will discuss 2009 more specifically and to the extent possible as part of our quarterly reporting. WACKER already decided on a catalog of measures in Q4 2008 to counter and thus limit the downturn's impact. Measures include budget cuts, short-time work, hiring restraints, modified investment planning and secure operational financing. We also anticipate positive effects from lower-than-expected raw material and energy costs compared to 2007.

WACKER Already Decided on Measures in Q4 2008 to Counter Economic Downturn

We assume that our silicon-wafer business will have a particularly difficult time in fiscal 2009. Currently, no reliable forecast is possible for WACKER SILICONES and WACKER POLYMERS. Despite the difficult economic environment, we see growth potential in 2009 at WACKER POLYSILICON and WACKER FINE CHEMICALS, which will profit from the expansion of plants and product lines. From today's vantage point, we expect 2009 consolidated sales to drop.

For 2010, we anticipate that the global economy will grow again and that the recession will essentially end. If this should be the case, WACKER will return to its long-term growth course and increase sales and earnings.

Future Dividends

Our policy on dividends is oriented toward distributing at least 25% of net income to shareholders, assuming the business situation allows this and the committees responsible agree.

Investments

WACKER's investments have continually risen over the past four years. In 2008, they reached a new record of over €900 million (excluding the acquisition of all shares in the two partner companies that WACKER operated with US-based Air Products) and will remain high in 2009, too. Due to the difficult environment, they will not be quite as high as the prior year, and will reflect further economic developments. Depending on economic developments, however, we may reduce our investment budget. Most of the funds are earmarked for our strategic growth projects at WACKER POLYSILICON. Investments currently planned for 2010 will exceed depreciation.

Investments Remain High in 2009

Financing

For companies, financing conditions became much tougher during 2008 and corporate financing and liquidity management have faced great challenges. At WACKER, we strive to finance the company without outside help to the greatest possible extent. On the financing and assets front, the global banking and financial crisis has had no noticeable effect on us yet. The key task for 2009 will be to secure the company's liquidity and to carefully manage cash flow.

As regards financing, we already extended a €300 million syndicated credit facility in 2008 by another year to 2013. We will review credit facilities set to expire in 2009 and 2010 in a timely manner to decide whether we need to extend their terms and replace them by building up further long-term credit lines. Moreover, we plan to build up further long-term credit lines soon. Despite the more difficult underlying conditions, WACKER's long-term financing and our ambitious investment program should thus remain on a solid footing. → See further details on page 106

Research and Development

In terms of R&D, we will continue to focus on our five research groups: catalysis and processes, functional materials, polymers, organic synthesis, and biotechnology. We intend to strengthen fields that will remain of major importance to us in the future. These include photovoltaics, energy and white biotechnology. As for the semiconductor industry, we are working on a new wafer generation that entails processes for design rules of 22 nanometers. R&D expenses in 2009 and 2010 are expected to be slightly above the prior-year figure.

Employees

Due to the difficult global economic situation in 2009 WACKER applied for short-time work in January for Siltronic AG and in February for Wacker Chemie AG. The measure will initially last six months in each case. This means that individual production facilities can adjust employee numbers flexibly to reflect their specific order and capacity-utilization levels. Some 6,000 production employees work at WACKER in Germany.

In 2009, we will hire new employees and use contract workers as needed. For the expansion of our polysilicon production plant in Nünchritz, we will nevertheless create some 120 additional jobs. WACKER will keep the number of vocational training slots constant. Recruiting young talent will continue to be a high Group priority. We expect the number of employees to remain more or less unchanged compared to the prior year, and to rise in 2010 due to our expansion projects.

Production

Over the next two years, WACKER will be commissioning new production capacities. The main focus will be on WACKER POLYSILICON.

WACKER Commis-
sions New Polysili-
con Plant in 2009

Commissioning of Production Facilities in 2009 and 2010

Site	Project	New Capacity	Commissioning
Nanjing	Dispersible polymer powder	30,000 t/a	2009
Burghausen	Polysilicon expansion stage 8	10,000 t/a	2009
Jena	Expansion of biologics production facility	–	2009
Zhangjiagang	Siloxane and pyrogenic silica	200,000 t/a (WACKER share: 25 and 51%, respectively)	2010

Improving plant productivity will remain a key topic at WACKER in the years ahead. In addition to our “Wacker Operating System” (WOS) program, we are planning to set up an academy to specially train our employees for this task.

Procurement

Over the next two years, we intend to further enhance groupwide procurement processes and more closely interlink collaborations with our international sites. Optimization of raw material procurement, reorganized in 2008, will remain an important focus. We are particularly involved in topics such as long-term supply reliability and the extension of competitive conditions.

Due to WACKER's large expansion investments, our focus for technical procurement and logistics is on optimizing the handling of large-project business. The challenges there not only include prices and quantities, but also ensuring that plants are commissioned on schedule. With its decision to invest in Nünchritz, WACKER is building its first ever polysilicon plant outside of Burghausen. This new production facility will involve restructuring the Nünchritz site's logistics in the years to come. To do so, we are planning to reorganize logistics for packaging material and technical supplies, as well as for finished polysilicon products – and interlink these with the site's existing logistics infrastructure.

Sustainability

WACKER controls its operational processes with the help of an integrated management system (IMS). In 2009, all our management systems will be certified to ISO 9001 (quality) and ISO 14001 (environmental protection). As a result, WACKER will be able to show a uniform standard of quality and environmental protection on a groupwide level. In addition, we intend to have all sites' workplace and plant safety certified to the globally-accepted OHSAS system in the next few years.

As early as 2007, WACKER started its Power Plus energy-conservation project at Burghausen and Nünchritz, its two sites with the highest energy consumption. The goal is to reduce specific energy usage 10% by the end of 2009. Subsequently, WACKER intends to continue promoting this project in the future.

WACKER completed REACH-related preregistration of chemical substances on schedule in 2008. The submission of registration dossiers will occupy us for the next ten years, right up to the extended deadline.

In 2009, moreover, we expect publication of the European Regulation on Classification, Labeling and Packaging of Substances and Mixtures (CLP, as part of the UN's GHS program). For us, this system switchover means that all hazardous substances must be checked, reclassified and labeled. Within just a few years, we must reclassify several thousand substances and products, change all material safety data sheets and redesign hazardous substance labels due to new hazard symbols and information obligations. The switchover to GHS will cost WACKER some €3 million.

A "New Prospects for Workplace Safety" initiative launched in 2007 is set for groupwide implementation, beginning at German sites. It will soon start at our WACKER Greater China subsidiary. By 2011, the Group's accident rate (per 1 million hours worked) is to be cut significantly compared to 2007.

General Overview of Expected Business Performance

WACKER is preparing for a global downturn in 2009. Despite this, we see good growth opportunities at WACKER POLYSILICON, even in 2009. The same applies to WACKER FINE CHEMICALS. The business trend at our three other divisions will be more difficult. We anticipate that sales and EBITDA will be below the prior-year figures. Due to the continually changing situation, it is very difficult to make an exact forecast here. Regardless of this fact, we are pressing ahead with our strategic growth projects. From today's viewpoint, we expect the global economy to resume its growth course in 2010.

This forecast takes account of all events known during our balance-sheet preparations that could influence our business development in 2009 and thereafter.

CH5 ...// Financial Statements

Our consolidated financial statements contain all the figures on the WACKER Group and its individual segments. They also contain the Supervisory Board report and a section on Corporate Governance.

121 Income Statement	122 Balance Sheet	124 Cash Flow Statement	125 Statement of Comprehensive Income	126 Statement of Changes in Equity	127 Reconciliation of Other Equity Items	128 Segment Information by Division
130 Segment Information by Region	131 Notes	192 Supervisory Board	194 Executive Board	195 Report of the Supervisory Board	200 Corporate Governance	202 Compensation Report
205 Declaration by the Executive Board	206 Auditor's Report	208 Glossary	211 Index A – Z			

CH5

WACKER POLYMERS ...//



Construction Chemicals for the 21st Century

...// Once a revolution in building construction, VINNAPAS® dispersible polymer powder now sets the benchmark for reducing energy costs and CO₂ emissions. In thermal insulation, polymer additives improve adhesion, processing, flexibility and stability at different points in the system. This ensures that EIFS provide environmental benefits and energy efficiency in all climate zones – both north and south of the equator. WACKER POLYMERS ranks among the world's leading producers of high-quality binders.

Income Statement

For the Period January 1 to December 31

Annual Report 2008

Wacker Chemie AG

121

Income Statement

€ million	2008	2007	Notes
Sales	4,298.1	3,781.3	→ 01
Cost of sales	-3,110.1	-2,629.3	
Gross profit from sales	1,188.0	1,152.0	
Selling expenses	-257.6	-233.5	
Research and development expenses	-163.2	-152.5	
General administrative expenses	-109.5	-94.1	
Other operating income	344.6	116.4	→ 01
Other operating expenses	-321.0	-137.1	→ 01
Operating result	681.3	651.2	
Income from investments in joint ventures and associates	-33.7	-9.3	→ 02
Other income from participations	0.3	7.7	→ 02
EBIT (earnings before interest and taxes)	647.9	649.6	
Net interest income	5.7	-1.0	→ 02
Other financial results	-10.9	-1.2	→ 02
Limited partnership interests	-0.9	-15.3	→ 02
Earnings before taxes	641.8	632.1	
Income taxes	-203.5	-209.9	→ 03
Net income	438.3	422.2	
of which			
attributable to Wacker Chemie AG shareholders	439.4	422.0	
accounted for by minority interests	-1.1	0.2	→ 12
Earnings per common share in € (basic/diluted)	8.84	8.49	→ 19

Balance Sheet

As of December 31

122 Consolidated Financial Statements ...// Balance Sheet

Assets

€ million	2008	2007	Notes
Intangible assets	24.7	10.1	→ 05
Property, plant, and equipment	2,659.6	2,123.4	→ 06
Investment property	3.6	1.5	→ 07
Investments in joint ventures and associates	191.8	196.2	→ 08
Financial assets	72.0	70.7	→ 08
Trade receivables	–	0.8	→ 10
Other assets	164.2	59.1	→ 10
Tax receivables	13.9	15.8	→ 10
Deferred tax assets	31.2	13.0	→ 03
Noncurrent assets	3,161.0	2,490.6	
Inventories	504.9	403.5	→ 09
Trade receivables	466.8	460.6	→ 10
Other assets	98.4	136.4	→ 10
Tax receivables	88.7	60.5	→ 10
Current securities	101.1	–	→ 11
Cash and cash equivalents (liquid assets)	204.2	366.5	→ 11
Liquidity	305.3	366.5	→ 11
Current assets	1,464.1	1,427.5	
	4,625.1	3,918.1	

Total Equity and Liabilities

€ million	2008	2007	Notes
Subscribed capital, Wacker Chemie AG	260.8	260.8	
Capital reserve, Wacker Chemie AG	157.4	157.4	
Treasury shares	- 45.1	- 45.1	
Retained earnings	1,751.9	1,541.3	
Other equity items	- 56.6	- 64.1	
Equity attributable to Wacker Chemie AG shareholders	2,068.4	1,850.3	
Minority interests	14.4	15.3	
Equity	2,082.8	1,865.6	→ 12
Minority shares in limited partnership capital	-	32.6	→ 02
Pension provisions	376.1	369.2	→ 13
Other provisions	170.2	166.8	→ 14
Tax provisions	90.8	78.2	→ 14
Deferred tax liabilities	51.5	40.4	→ 03
Financial indebtedness	158.7	164.2	→ 15
Other liabilities	855.6	609.5	→ 16
Noncurrent liabilities	1,702.9	1,460.9	
Other provisions	24.6	14.5	→ 14
Tax provisions	57.8	22.9	→ 14
Tax liabilities	14.1	13.4	→ 16
Financial indebtedness	113.7	53.6	→ 15
Trade payables	296.7	241.8	→ 16
Other liabilities	332.5	245.4	→ 16
Current liabilities	839.4	591.6	
Liabilities	2,542.3	2,052.5	
	4,625.1	3,918.1	

Cash Flow Statement

For the Period January 1 to December 31

124 Consolidated Financial Statements ...// Cash Flow Statement

Cash Flow Statement

€ million	2008	2007	Notes
Net income	438.3	422.2	
Write-downs and impairments/write-ups of noncurrent assets	407.3	351.9	
Change in provisions	59.6	69.1	
Change in deferred taxes	3.2	17.1	
Other non-cash expenses and income	8.8	15.3	
Result from disposal of noncurrent assets	-13.0	-0.3	
Result from equity accounting and joint venture dividends	36.2	9.7	
Change in inventories	-71.5	-3.7	
Change in trade receivables	25.7	-4.0	
Change in other assets	-108.1	-23.1	
Change in other liabilities	21.8	55.1	
Change in advance payments made and received	197.7	413.2	
Cash flow from operating activity (gross cash flow)	1,005.4	1,322.5	→ 21
Investment in intangible assets, property, plant, and equipment as well as investment property	-747.1	-562.5	
Investment in financial assets	-30.8	-120.4	
Payments for loans at joint ventures	-60.3	-	
Proceeds from the disposal of intangible assets, property, plant, and equipment	22.3	3.7	
Proceeds from the disposal of associates/financial assets	3.4	0.4	
Cash outflows for acquisitions	-171.2	-	
Cash flow from noncurrent investment activity	-983.7	-678.8	
Acquisition of current securities	-101.1	-	
Cash flow from investment activity	-1,084.8	-678.8	→ 21
Dividends paid	-149.1	-124.2	
Capital contributions from minority interests	2.4	-	
Dividends paid to minority interests	-0.3	-0.3	
Withdrawal of limited partnership capital	-	-13.9	
Bank loans raised	73.6	19.6	
Bank loans repaid	-20.0	-189.1	
Other financial liabilities incurred	21.9	6.0	
Other financial liabilities repaid	-16.2	-17.0	
Cash flow from financing activity	-87.7	-318.9	→ 21
Change due to exchange rate fluctuations	4.8	-1.2	
Change in cash and cash equivalents	-162.3	323.6	→ 11
At beginning of year	366.5	42.9	
At year-end	204.2	366.5	

Additional Information

Cash flow from operating activity (gross cash flow)	1,005.4	1,322.5
Cash flow from noncurrent investment activity	-983.7	-678.8
Net cash flow	21.7	643.7

Statement of Comprehensive Income

For the Period January 1 to December 31

Annual Report 2008

Wacker Chemie AG

125

Statement of Comprehensive Income

€ million	2008	2007
Net income	438.3	422.2
Changes in fair values of securities available for sale	0.6	–
Change in foreign currency translation adjustments	49.6	– 35.2
Cash flow hedge	– 57.6	22.1
Pro rata cash flow hedge at companies accounted for using the equity method	– 1.1	0.3
Deferred taxes	16.0	– 4.6
Minority interests	– 0.1	– 0.5
Total income and expenses recognized in equity	7.4	– 17.9
Total income and expenses reported in the fiscal year	445.7	404.3
of which		
attributable to Wacker Chemie AG shareholders	446.9	404.6
accounted for by minority interests	– 1.2	– 0.3

Statement of Changes in Equity

For the Period January 1 to December 31

126 Consolidated Financial Statements ...// Statement of Changes in Equity

Statement of Changes in Equity

€ million	Subscribed capital	Capital reserve	Treasury shares	Retained earnings/	Other equity items ¹	Total	Minority interests	Total
Jan. 1, 2007	260.8	157.4	- 45.1	1,243.5	- 46.7	- 1,569.9	15.9	1,585.8
Net income	-	-	-	422.0	-	422.0	0.2	422.2
Dividends paid	-	-	-	- 124.2	-	- 124.2	- 0.3	- 124.5
Income and expenses recognized in equity	-	-	-	-	- 17.4	- 17.4	- 0.5	- 17.9
Dec. 31, 2007	260.8	157.4	- 45.1	1,541.3	- 64.1	1,850.3	15.3	1,865.6
Jan. 1, 2008	260.8	157.4	- 45.1	1,541.3	- 64.1	1,850.3	15.3	1,865.6
Net income	-	-	-	439.4	-	439.4	- 1.1	438.3
Dividends paid	-	-	-	- 149.1	-	- 149.1	- 0.3	- 149.4
Capital contributions	-	-	-	-	-	-	2.4	2.4
Income and expenses recognized in equity	-	-	-	-	7.5	7.5	- 0.1	7.4
Scope of consolidation/other	-	-	-	- 79.7	-	- 79.7	- 1.8	- 81.5
Dec. 31, 2008	260.8	157.4	- 45.1	1,751.9	- 56.6	2,068.4	14.4	2,082.8

¹Cf. Note 12

Reconciliation of Other Equity Items

For the Period January 1 to December 31

Annual Report 2008

Wacker Chemie AG

127

Reconciliation of Other Equity Items

€ million	Changes in the fair value of securities available for sale	Exchange rate adjustment	Cash flow hedge	Total (excluding minority interests)
Gross values Jan. 1, 2007	–	– 58.5	11.8	– 46.7
Additions	–	–	45.1	45.1
Disposals	–	–	0.5	0.5
Reclassification in the income statement	–	–	– 23.2	– 23.2
Change in exchange rates	–	– 35.2	–	– 35.2
Deferred taxes				
Additions	–	–	– 12.3	– 12.3
Disposals	–	–	– 0.2	– 0.2
Reclassification in the income statement	–	–	7.9	7.9
Dec. 31, 2007	–	– 93.7	29.6	– 64.1
Gross values Jan. 1, 2008	–	– 93.7	29.6	– 64.1
Additions	0.6	–	– 23.8	– 23.2
Disposals	–	–	– 2.0	– 2.0
Reclassification in the income statement	–	–	– 32.9	– 32.9
Change in exchange rates	–	49.6	–	49.6
Deferred taxes				
Additions	– 0.2	–	6.6	6.4
Disposals	–	–	0.3	0.3
Reclassification in the income statement	–	–	9.3	9.3
Dec. 31, 2008	0.4	– 44.1	– 12.9	– 56.6

Segment Information by Division

For the Period January 1 to December 31

128 Consolidated Financial Statements ...// Segment Information by Division

2008								
€ million	Siltronic	Silicones	Polymers	Polysilicon	Fine Chemicals	Other	Consolidation	Group
External sales	1,356.2	1,363.5	860.4	567.0	92.0	59.0	–	4,298.1
Internal sales	4.6	45.1	7.5	261.1	5.7	260.4	– 530.4	–
Total sales	1,360.8	1,408.6	867.9	828.1	97.7	265.4	– 530.4	4,298.1
EBIT	193.8	86.3	64.9	349.8	6.0	– 51.7	– 1.2	647.9
Write-downs and impairments/ write-ups	163.5	81.6	44.0	72.2	3.2	42.8	–	407.3
EBITDA	357.3	167.9	108.9	422.0	9.2	– 8.9	– 1.2	1,055.2
EBIT includes: Income from investments in joint ventures and associates	– 22.4	– 11.0	–	1.3	–	– 1.6	–	– 33.7
Impairment losses	– 22.2	–	– 8.0	–	–	–	–	– 30.2
Additions to property, plant, and equipment ¹	139.2	80.8	74.4	410.3	16.5	105.2	–	826.4
Additions to financial assets ²	60.4	26.2	–	–	–	3.3	–	89.9
Asset additions	199.6	107.0	74.4	410.3	16.5	108.5	–	916.3
Assets (Dec. 31)	1,371.4	1,007.4	456.0	1,126.4	66.3	873.3	– 275.7	4,625.1
Liabilities (Dec. 31)	394.7	413.6	151.6	1,175.9	22.5	637.4	– 253.4	2,542.3
Net assets (Dec. 31)	976.7	593.8	304.4	– 49.5	43.8	235.9	– 22.3	2,082.8
Investments in joint ventures and associates included in net assets (Dec. 31)	114.2	43.6	–	34.0	–	–	–	191.8
Research and development expenses	– 67.7	– 31.5	– 15.0	– 5.4	– 2.3	– 41.3	–	– 163.2
Employees (Dec. 31)	5,469	3,927	1,579	1,289	259	3,399	–	15,922
Employees (average)	5,566	3,923	1,561	1,156	255	3,337	–	15,798

¹Intangible assets, property, plant, and equipment, investment property

²Investments in joint ventures and associates, financial assets

The segment information by division is an integral part of the Notes to the Consolidated Financial Statements. For explanations of the key indicators → see Note 22.

2007

€ million	Siltronic	Silicones	Polymers	Polysilicon	Fine Chemicals	Other	Consolidation	Group
External sales	1,445.1	1,313.6	623.7	243.8	100.6	54.5	–	3,781.3
Internal sales	6.5	47.4	9.1	213.1	11.8	192.7	– 480.6	–
Total sales	1,451.6	1,361.0	632.8	456.9	112.4	247.2	– 480.6	3,781.3
EBIT	337.2	144.6	80.5	135.0	– 7.5	– 40.2	–	649.6
Write-downs and impairments/ write-ups	140.9	82.3	26.5	47.2	17.0	38.0	–	351.9
EBITDA	478.1	226.9	107.0	182.2	9.5	– 2.2	–	1,001.5
EBIT includes: Income from investments in joint ventures and associates	– 7.2	– 3.7	–	1.5	–	0.1	–	– 9.3
Impairment losses	– 2.5	– 0.1	– 8.9	–	– 12.5	– 0.7	–	– 24.7
Additions to property, plant, and equipment ¹	118.4	100.7	41.0	228.3	7.5	82.6	–	578.5
Additions to financial assets ²	81.6	1.5	–	31.2	–	6.5	–	120.8
Asset additions	200.0	102.2	41.0	259.5	7.5	89.1	–	699.3
Assets (Dec. 31)	1,230.6	973.0	255.3	618.9	52.3	875.2	– 87.2	3,918.1
Liabilities (Dec. 31)	354.9	325.9	80.7	767.7	18.6	578.8	– 74.1	2,052.5
Net assets (Dec. 31)	875.7	647.1	174.6	– 148.8	33.7	296.4	– 13.1	1,865.6
Investments in joint ventures and associates included in net assets (Dec. 31)	134.6	23.3	–	32.7	–	5.6	–	196.2
Research and development expenses	– 63.9	– 35.9	– 7.6	– 6.3	– 2.1	– 36.7	–	– 152.5
Employees (Dec. 31)	5,634	3,871	1,128	1,003	245	3,163	–	15,044
Employees (average)	5,628	3,828	1,095	953	279	3,143	–	14,926

¹Intangible assets, property, plant, and equipment, investment property

²Investments in joint ventures and associates, financial assets

The segment information by division is an integral part of the Notes to the Consolidated Financial Statements. For explanations of the key indicators → see Note 22.

Segment Information by Region

For the Period January 1 to December 31

130 Consolidated Financial Statements ...// Segment Information by Region

2008

€ million	Germany	Europe (excl. Germany)	Americas	Asia	Other regions	Consolidation	Group
External sales by customer headquarters	948.6	1,008.2	852.9	1,362.8	125.6	–	4,298.1
External sales by Group company headquarters	3,746.8	29.4	736.4	546.3	2.2	– 763.0	4,298.1
Additions to property, plant, and equipment ¹	736.5	0.8	23.0	65.7	0.4	–	826.4
Additions to financial assets ²	29.5	60.3	–	0.1	–	–	89.9
Asset additions	766.0	61.1	23.0	65.8	0.4	–	916.3
Assets (Dec. 31)	4,370.8	743.1	451.1	609.1	1.2	– 1,550.2	4,625.1
Liabilities (Dec. 31)	2,544.2	71.1	164.1	366.7	0.9	– 604.7	2,542.3
Net assets (Dec. 31)	1,826.6	672.0	287.0	242.4	0.3	– 945.5	2,082.8
Research and development expenses	– 142.8	–	– 14.1	– 10.6	–	4.3	– 163.2
Employees (Dec. 31)	12,110	185	1,780	1,834	13	–	15,922

2007

€ million	Germany	Europe (excl. Germany)	Americas	Asia	Other regions	Consolidation	Group
External sales by customer headquarters	723.5	1,034.7	642.6	1,267.1	113.4	–	3,781.3
External sales by Group company headquarters	3,341.0	26.6	659.1	480.2	1.8	– 727.4	3,781.3
Additions to property, plant, and equipment ¹	521.1	4.0	10.5	42.7	0.2	–	578.5
Additions to financial assets ²	39.2	81.6	–	–	–	–	120.8
Asset additions	560.3	85.6	10.5	42.7	0.2	–	699.3
Assets (Dec. 31)	3,823.0	571.1	304.5	501.4	0.9	– 1,282.8	3,918.1
Liabilities (Dec. 31)	2,152.6	155.5	135.7	206.8	0.6	– 598.7	2,052.5
Net assets (Dec. 31)	1,670.4	415.6	168.8	294.6	0.3	– 684.1	1,865.6
Research and development expenses	– 136.8	–	– 10.8	– 9.9	–	5.0	– 152.5
Employees (Dec. 31)	11,624	174	1,596	1,639	11	–	15,044

¹ Intangible assets, property, plant, and equipment, investment property

² Investments in joint ventures and associates, financial assets

The segment information by region is an integral part of the Notes to the Consolidated Financial Statements. For explanations of the key indicators → see Note 22.

Accounting Principles and Methods

Wacker Chemie AG is a listed company with its headquarters in Munich, Germany.

Wacker Chemie AG's consolidated financial statements have been prepared in accordance with the International Financial Reporting Standards (IFRS), as applicable in the European Union, and the supplementary rules in Section 315a (1) of the German Commercial Code (HGB).

All the interpretations of the International Financial Reporting Interpretations Committee (IFRIC) which are applicable for the current fiscal year are likewise applied.

To improve the clarity of presentation, various items in the income statement and the balance sheet have been combined. These items are shown and explained separately in the Notes.

The Group's functional currency is the euro. All amounts are shown in millions of euros (€ million) unless otherwise stated.

The consolidated financial statements, the Group management report, and any other documents subject to disclosure requirements are submitted to the publisher of the online German Federal Bulletin. Wacker Chemie AG is registered at Munich Local Court (Amtsgericht) under HRB 159705. The consolidated financial statements and the Group management report can also be viewed on the WACKER website. → www.wacker.com

The declaration concerning the German Corporate Governance Code required by § 161 of the German Stock Corporation Act (AktG) has been submitted and made accessible to the shareholders on the WACKER website. → www.wacker.com

The Executive Board of Wacker Chemie AG authorized the consolidated financial statements for issue and submitted them for presentation to the Supervisory Board's Audit Committee on February 20, 2009. They will be submitted to the Supervisory Board for its meeting on March 12, 2009.

Standards/Interpretations Not Applied Earlier

The International Accounting Standards Board (IASB) has published the following standards, interpretations, and changes to existing standards which are not yet binding and which Wacker Chemie AG will not apply earlier than required.

Standards/Interpretations and Changes to Existing Standards Already Endorsed by the European Union

IFRS 1: "First-time Adoption of the International Financial Reporting Standards" and IAS 27: "Consolidated and Separate Financial Statements": Cost of an Investment in a Subsidiary, Jointly Controlled Entity are Associate

In May 2008, the IASB adopted a change in both of the above standards which must be applied for the first time in the fiscal year which begins on or after January 1, 2009. The change was endorsed by the European Union on January 23, 2009. We are assuming that these standards' application will have no impact on Wacker Chemie AG's consolidated financial statements.

IFRS 2: “Share-based Payment”

The IASB amended IFRS 2 in January 2008. The first mandatory application of this amended standard is for fiscal years beginning on or after January 1, 2009. The change was endorsed by the European Union on December 16, 2008. We are assuming that its application will have no impact on Wacker Chemie AG's consolidated financial statements.

IFRS 8: “Operating Segments”

The first mandatory application of this amended standard is for fiscal years beginning on or after January 1, 2009. Earlier application is possible. The standard was endorsed by the European Union on November 21, 2007. Wacker Chemie AG will apply them for the first time in the fiscal year 2009. This is expected to have little impact on Wacker Chemie AG's consolidated financial statements.

IAS 23: “Borrowing Costs”

The first mandatory application of this amended standard is for fiscal years beginning on or after January 1, 2009. The changes were endorsed by the European Union on December 10, 2008. As a result of the revised standard, borrowing costs related to certain investment projects will no longer be expensed as incurred. Instead, they will be capitalized as part of acquisition and production costs. The changes will therefore tend to lead to higher asset additions and, consequently, an increase in depreciation. Apart from that, lower interest expenses can be expected. The impact of these amendments cannot be estimated a priori.

IAS 32: “Financial Instruments: Presentation” and IAS 1: “Presentation of Financial Statements”: Puttable Financial Instruments and Obligations Arising on Liquidation

The IASB adopted changes to IAS 1 and IAS 32 in February 2008. The changes must be applied for the first time in the fiscal year which begins on or after January 1, 2009. They were endorsed by the European Union on January 21, 2009. As things stand at present, the application of the changed standards will have no impact on Wacker Chemie AG's consolidated financial statements.

“Improvements to IFRS”

In May 2008, the IASB adopted a series of changes to existing standards which were all publicized together. Most of the changes must be applied in the fiscal year which begins on or after January 1, 2009 and some in the fiscal year which begins on or after July 1, 2009. They were endorsed by the European Union on January 23, 2009. Their first-time application will have little or no impact on Wacker Chemie AG's consolidated financial statements.

IFRIC 13: “Customer Loyalty Programmes”

The interpretation is to be used for the first time in the fiscal year beginning on or after July 1, 2008. The changes were endorsed by the European Union on December 16, 2008. We are assuming that its application will have no impact on Wacker Chemie AG's consolidated financial statements.

Standards, Interpretations, and Changes to Existing Standards Not Yet Endorsed by the European Union

IFRS 1: "First-time Adoption of the International Financial Reporting Standards"

In November 2008, the IASB adopted changes to IFRS 1. The changes to this standard must be applied for the first time in the fiscal year which begins on or after July 1, 2009. The changed standard has not yet been endorsed by the European Union. Its application will have no impact on Wacker Chemie AG's consolidated financial statements.

IFRS 3: "Business Combinations"

The IASB amended IFRS 3 in January 2008 as a consequence of the "Business Combinations – Phase II" project. The first mandatory application of this amended standard is for fiscal years beginning on or after July 1, 2009. The changed standard has not yet been endorsed by the European Union. In the event of future company acquisitions, the application of this standard could produce results different from those that would have been obtained under previous IFRS rules. This is most likely to be the case when not all of a company's shares are acquired.

IAS 27: "Consolidated and Separate Financial Statements"

The first mandatory application of this amended standard is for fiscal years beginning on or after July 1, 2009. The changes have not yet been endorsed by the European Union. The revised standard will have to be observed in the course of future company acquisitions and will therefore have an impact on Wacker Chemie AG's consolidated financial statements. Particular constellations have not yet been covered by IAS 27, especially with regard to gradual company acquisitions. The extent to which these changes will make us change our accounting methods cannot yet be assessed due to a lack of relevant data.

IAS 39: "Financial Instruments: Recognition and Measurement – Eligible Hedged Items"

In July 2008, the IASB adopted changes to IAS 39 which must be applied for the first time in the fiscal year that begins on or after July 1, 2009. These have not yet been endorsed by the European Union. The revised standard contains additions to the application guidelines in respect of particular aspects of hedge accounting. At the moment, we are not assuming that its application will have any impact on Wacker Chemie AG's consolidated financial statements.

IAS 39: "Financial Instruments: Recognition and Measurement" and IFRS 7: "Financial Instruments: Disclosures"

In October 2008, the IASB adopted changes to the two standards specified above which must be applied retroactively as from July 1. Then, in November 2008, there followed the publication of an additional change to these two standards which affects the application and transition guidelines. The changes have not yet been endorsed by the European Union. Due to a lack of relevant data, we do not expect the application of the revised standard to have any impact on Wacker Chemie AG's consolidated financial statements.

IFRIC 12: “Service Concession Arrangements“

The first mandatory application of this interpretation is in the fiscal year beginning on or after January 1, 2008. It has not yet been endorsed by the European Union. We are assuming that its application will have no impact on Wacker Chemie AG's consolidated financial statements.

IFRIC 15: “Agreements for the Construction of Real Estate“

The first mandatory application of this interpretation is in the fiscal year beginning on or after January 1, 2009. It has not yet been endorsed by the European Union. We are assuming that its application will have no impact on Wacker Chemie AG's consolidated financial statements.

IFRIC 16: “Hedges of a Net Investment in a Foreign Operation“

The first mandatory application of this interpretation is in the fiscal year beginning on or after October 1, 2008. It has not yet been endorsed by the European Union. We are assuming that its application will have no material impact on Wacker Chemie AG's consolidated financial statements.

IFRIC 17: “Distribution of Non-cash Assets to Owners“

This interpretation must be applied for the first time in the fiscal year that begins on or after July 1, 2009. It has not yet been endorsed by the European Union. We are assuming that its application will have no material impact on Wacker Chemie AG's consolidated financial statements.

IFRIC 18: “Transfer of Assets from Customer“

This interpretation must be applied for the first time in the fiscal year that begins on or after July 1, 2009. It has not yet been endorsed by the European Union. We are assuming that its application will have no material impact on Wacker Chemie AG's consolidated financial statements.

Scope of Consolidation

The consolidated financial statements include the financial statements of Wacker Chemie AG and its subsidiaries. Subsidiaries are defined as companies in which Wacker Chemie AG directly or indirectly holds a voting majority or exercises control. Joint ventures and associated companies are defined as companies in which Wacker Chemie AG exercises significant influence, which normally means that it holds 20–50% of the voting rights. These entities are included in the consolidated financial statements using the equity method. If subsidiaries and joint ventures have their own subsidiaries, these are not included in the table below. Companies in which Wacker Chemie AG has a shareholding of less than 20% are shown as other investments under noncurrent financial assets.

	Germany	Europe (excl. Germany)	Americas	Asia	Other regions	Total
Fully Consolidated Subsidiaries (incl. Proprietary Company)						
Jan. 1, 2008	17	13	6	19	1	56
Additions	2	1	2	2	–	7
Disposals and mergers	–3	–1	–2	–1	–	–7
Reclassifications	–	–	–	1	–	1
Dec. 31, 2008	16	13	6	21	1	57
Companies Accounted for Using the Equity Method						
Jan. 1, 2008	2	–	2	5	–	9
Disposals and mergers	–	–	–1	–	–	–1
Reclassifications	–	–	–	–1	–	–1
Dec. 31, 2008	2	–	1	4	–	7
Non-consolidated Affiliated Companies¹						
Jan. 1, 2008	1	–	–	–	–	1
Dec. 31, 2008	1	–	–	–	–	1
Total						
Jan. 1, 2008	20	13	8	24	1	66
Additions	2	1	2	2	–	7
Disposals and mergers	–3	–1	–3	–1	–	–8
Dec. 31, 2008	19	13	7	25	1	65

¹Not consolidated on grounds of insignificance (W.E.L.T. Reisebüro GmbH; shareholding: 51%; sales in 2007 fiscal year below €1 million; total assets below €0.5 million)

**Additions and Reclassifications at Fully Consolidated Subsidiaries/
Companies Consolidated Using the Equity Method**

%	
Additions	
Wacker Polymers GmbH & Co. KG, Burghausen (acquired as of Jan. 31, 2008)	100
Wacker Polymers Verwaltungs GmbH, Hattingen (acquired as of Jan. 31, 2008)	100
Wacker Polymers B.V., Utrecht, Netherlands (acquired as of Jan. 31, 2008)	100
Wacker Polymers, L.P., Allentown (PA), USA (acquired as of Jan. 31, 2008)	100
Wacker Polymers Holdings, LP., Allentown (PA), USA (acquired as of Jan. 31, 2008)	100
Wacker Chemie India Pvt. Ltd., Mumbai, India (shares acquired immediately after foundation, September 2008)	100
Wacker Chemicals Middle East Ltd., Dubai (founded in May 2008)	100
Reclassifications	
Air Products Korea, Inc., Seoul, South Korea (acquired as of Jan. 31, 2008)	100

Disposals/Mergers of Fully Consolidated Subsidiaries

%	
Wacker Polymers GmbH & Co. KG, Burghausen (merged with Wacker Chemie AG as of Aug. 1, 2008)	100
Wacker-Chemie Holdings GmbH & Co. KG, Burghausen (merged with Wacker Chemie AG as of Aug 1, 2008)	100
Wacker Polymers, L.P., Allentown (PA), USA (merged with Wacker Chemical Corporation, Inc. as of Aug. 1, 2008)	100
Wacker Polymers Holdings, LP., Allentown (PA), USA (merged with Wacker Chemical Corporation, Inc. as of Aug. 1, 2008)	100
Wacker Polymers B.V., Utrecht, NL (merged with Wacker-Chemie Benelux B.V. as of Dec. 4, 2008)	100
Wacker Silicone Korea Ltd., Seoul, South Korea (liquidation in December 2008)	100
Wacker Polymers Verwaltungs GmbH, Hattingen (merged with Wacker Chemie AG in accordance with the contract of Dec. 23, 2008, entered in the commercial register on Jan. 1, 2009)	100

Disposals/Mergers at Companies Accounted for Using the Equity Method

APP-Mexico	35
------------	----

In addition to the acquisitions of the shares in the former APP companies that are disclosed separately, the additions in the year under review refer to the following Group companies. In early 2008, Wacker Chemicals Middle East Ltd. in Dubai was established. The company is a distributor and a technical center is currently being built there. As of the balance sheet date, the company has no material impact on the Group's net assets, financial position, or results of operations. In addition, 100% of the shares in Wacker Chemie India Private Limited were acquired in order to conclude the company's foundation phase in the third quarter of 2008. As of the balance sheet date, the two companies have no material impact on the Group's net assets, financial position, or results of operations.

Acquisition of the Shares in the Former APP Companies and Restructuring of the Group

The contract for the purchase of the shares in several partner companies previously held by Air Products and Chemicals, Inc. (Allentown, PA, USA), which had been signed in December 2007, took effect on January 31, 2008. In this transaction, WACKER acquired 80.6226% of the shares in Air Products Polymers Holdings, L.P. and 65% of the shares in Air Products Korea, Inc., thereby increasing its previous shareholdings in both of these companies to 100%. Air Products Polymers Holdings, L.P. functions as an intermediate holding company for the following APP companies: Air Products Polymers, L.P., (Allentown, PA, USA); Air Products Polymers GmbH & Co. KG, Burghausen, Germany; Air Products Polymers Verwaltungs GmbH, Hattingen, Germany; and Air Products Polymers B.V., Utrecht, NL. These companies are engaged in vinyl acetate ethylene (VAE) activities with dispersions. The transaction gave WACKER full control over the VAE activities, thereby enabling it to optimize the legal structure of its activities in the Polymers segment. As a further part of the transaction, WACKER acquired some assets from Air Products and Chemicals, Inc. at the Calvert City site.

Particular Air Products Polymers, L.P. sites were not acquired in this transaction, but by means of a disproportional dividend distribution transferred to the previous majority shareholder.

The purchase price for the shares in the APP companies, including the aforementioned assets acquired individually, was €97.8 million. This was paid entirely by means of cash and cash equivalents.

The acquired assets and liabilities considered were included in the consolidated financial statements for the first time upon acquisition at fair value. This resulted in a negative difference between the APP companies' net assets and the acquisition costs. The following table lists the values stated for the date of first-time consolidation and the proportion of the Group's carrying amounts as of the reporting date. The changes in the scope of consolidation that came about in the previous year had no material effect on the net assets, financial position, or results of operations. The following table therefore contains no figures from the previous year:

Carrying Amounts as of First-time Consolidation

€ million	2008	%
Intangible assets/property, plant, and equipment	109.4	4.1
Inventories	26.9	5.3
Receivables and other assets	54.7	11.7
Cash and cash equivalents	40.0	13.1
Liabilities and provisions	55.8	2.2
Net assets	175.2	8.4
Acquisition cost of the shares	160.9	-
Difference	- 14.3	-

The above acquisition costs for the shares include the purchase price now paid, as well as the acquisition costs previously reported under noncurrent financial assets. Due to a lack of information about the market values of the assets and debts at that time, it is not possible to treat the two blocks of shares separately in respect of the differences that have arisen.

The surplus of net assets over the acquisition cost of the shareholdings in APP Holdings, L.P. and APP Korea, Inc. is shown under other operating income. Carrying values from the date of transaction on the basis of applicable IFRS standards are not available as the necessary information could not be ascertained. At the same time, the withdrawal of the assets and debts of the two aforementioned Air Products Polymers, L.P. sites means that a presentation of the consolidated sales and earnings from January 1, 2008 is not possible as the necessary figures cannot be ascertained without undue effort and expense.

As of August 1, 2008, as part of a comprehensive legal restructuring of the shareholdings, Wacker Polymers GmbH & Co. KG, Burghausen, Germany (formerly Air Products Polymers GmbH Co. KG) and Wacker Chemie Holdings GmbH & Co. KG were merged with Wacker Chemie AG. At the same time, Wacker Polymers Holdings, L.P. (formerly Air Products Polymers Holdings, L.P.) and Wacker Polymers, L.P. (formerly Air Products Polymers, L.P.) were merged with Wacker Chemical Corporation, Inc. In December 2008, Wacker Polymers Verwaltungs GmbH (formerly Air Products Polymers Verwaltungs GmbH) was merged into Wacker Chemie AG and Wacker Polymers B.V. (formerly Air Products Polymers B.V.) was merged into Wacker-Chemie Benelux B.V.

Consolidation Methods

The consolidated financial statements are based on the financial statements of Wacker Chemie AG and its consolidated subsidiaries. With one exception, they have December 31 as their closing date. All of the individual financial statements were audited by independent auditors for the purposes of inclusion in the consolidated financial statements.

The capital consolidation, in accordance with the purchase method, is carried out by setting off the acquisition cost against the Group's share in the equity of the consolidated subsidiaries at the time of their acquisition or first inclusion in the consolidated financial statements. The consolidated subsidiaries' equity is calculated on the basis of all identifiable assets and liabilities, while all the balance sheet items are measured at fair values. If the acquisition cost of the investment is greater than the pro rata equity ascertained in this way, the positive difference is capitalized as goodwill and subjected to an annual impairment test. If it is lower, the negative difference is recognized directly as income.

Investments accounted for using the equity method are initially measured at cost. If the cost exceeds the pro rata share of equity, the difference is included in the carrying amount of the investment. The carrying amount has to be tested for possible impairment losses as of the balance sheet date. If the cost is lower than the share of equity at the time of acquisition, this difference is included in the carrying amount and recorded in the income statement as income from investments in joint ventures and associates. All of the other investments are reported as available-for-sale financial instruments.

Intragroup results, sales, expenses, income, receivables, and liabilities between the consolidated companies as well as pro rata profits and losses resulting from transactions with associated companies are eliminated.

For those consolidation entries which affect income, the income tax effect is taken into account and deferred taxes are included.

Foreign Currency Translation

In the Group companies' individual financial statements, all of the receivables and liabilities in foreign currencies are translated at the rate prevailing on the balance sheet date, regardless of whether or not they have been hedged. Forward contracts which, from an economic point of view, are used for hedging are reported at fair value.

The financial statements of consolidated companies which are prepared in the local currencies are translated on the basis of the functional currency principle using the modified reporting date rate method. As the Group's subsidiaries conduct their business along autonomous lines financially, commercially, and organizationally, the functional currency is basically identical to the company's local currency. In the consolidated financial statements, expenses and income from the financial statements of subsidiaries prepared in a foreign currency are therefore basically translated at the average rate for the year, whereas assets and liabilities are translated at the closing date rate. Any currency differences arising from the translation of equity are recognized in the other equity items. Translation differences resulting from divergent exchange rates in the income statement are likewise included. If any Group companies are removed from the consolidated group, any translation difference is reclassified from equity to profit or loss.

The Exchange Rates of the Most Important Currencies Reported in These Financial Statements Have Fluctuated Against the Euro as Follows:

	ISO Code	Reporting date rate		Average rate for the year	
		Dec. 31, 2008	Dec. 31, 2007	2008	2007
US dollar	USD	1.41	1.47	1.47	1.37
Japanese yen	JPY	127.23	164.86	152.17	161.14
Singapore dollar	SGD	2.02	2.11	2.08	2.06
Chinese renminbi	CNY	9.61	10.74	10.22	10.41

Accounting Principles

The financial statements of Wacker Chemie AG and the German and international subsidiaries are prepared in accordance with uniform accounting principles. The preparation of the consolidated financial statements in compliance with IFRS necessitates assumptions and estimates affecting the amounts and the reporting of the recognized assets and debts, income and expenses, and contingencies. The assumptions on which the estimates are based relate primarily to the uniform determination of useful lives throughout the Group, the recognition and measurement of provisions, the scope for realizing future tax relief, and the assumptions in connection with impairment tests. The actual values may in individual cases differ from the assumptions and estimates that were made. Changes in value are recognized as soon as they become apparent and affect the results for the period when the change occurred and, if applicable, in future reporting periods.

Significant risks inherent in the environmental protection provisions that may affect the levels of assets and liabilities reported in the balance sheet are possible changes in the cost estimates, changes in the likelihood of their utilization, and enhanced statutory provisions on the elimination and prevention of environmental damage. → See Note 14

In principle, there is also the risk of future cash inflows from property, plant, and equipment not being high enough to justify the carrying amounts stated. In this case, there would be impairments.

In principle, the values from the reporting period and those of the comparative period are comparable, as no shortened fiscal year was applied; instead, each period encompasses a calendar year. Limits to comparability may occur in the case of large-scale acquisitions of fully consolidated companies. This topic was dealt with in the explanation of the scope of consolidation. Insofar as amounts from the previous year are adjusted, these are explained in the relevant Notes.

Sales are recognized when goods and services have been duly delivered or rendered, respectively, and the ownership and risks have devolved upon the purchaser. Sales also include income from services. Information on the development of sales by segment and region is provided in the section on segment reporting.

Production costs show the costs of the products, merchandise, and services sold. In addition to directly attributable costs, such as material costs, personnel expenses, and energy costs, they encompass overheads including depreciation and inventory write-downs. This item also includes the cost of outward freight.

Selling expenses include costs incurred by the sales organization, advertising, market research, and application support on customers' premises. This item also includes commission expenses.

Research and development expenses include costs incurred in the development of products and processes. Research costs in the narrower sense are recognized as expenses when they are incurred. They are not capitalized. Development costs are capitalized only when all the prescribed recognition criteria have been met cumulatively, the research phase can be separated clearly from the development phase, and the costs incurred can be allocated to the individual projects without any overlaps. At the moment, not all the capitalization criteria in IAS 38 have been met due to numerous interdependencies within development projects and the uncertainty about which products will ultimately become commercially viable.

General administrative expenses include the pro rata personnel expenses and cost of materials of central Group control functions, human resources, accounting, and information technology, unless they have been charged as an internal service to other cost centers and therefore perhaps to other functional areas.

Intangible assets separately acquired are measured at cost and, if their useful lives can be determined, are amortized regularly on a straight-line basis. The useful life is taken to be between four and eight years unless otherwise indicated, e.g. by the life of a patent. Amortization of intangible assets (apart from goodwill) is allocated to the functional areas that use them. Intangible assets with indefinite useful lives undergo an annual impairment test. At the moment, these, without exception, are goodwill.

Self-generated intangible assets are capitalized if it is probable that a future economic benefit can be associated with the use of the asset and the costs of the asset can be determined reliably. They are recognized at cost and amortized regularly using the straight-line method. Their stated useful lives correspond to those of the intangible assets separately acquired. If development costs are capitalized, they are comprised of the costs directly and indirectly attributable to the development process. Capitalized development costs are amortized regularly over the useful life of the corresponding production facilities as from the start of production.

Goodwill is not amortized regularly. Existing goodwill undergoes an annual impairment test. If the impairment test indicates a recoverable amount that is lower than the carrying amount, the goodwill is reduced to its recoverable amount and an impairment loss is recognized. The intrinsic value, furthermore, is examined when events or circumstances indicate possible impairment. The impairments of goodwill are presented under other operating expenses.

We capitalize property, plant, and equipment at cost and depreciate them regularly using the straight-line method in accordance with their expected useful lives. In addition to the purchase price, acquisition costs include incidental acquisition costs as well as any costs incurred in the demolition, dismantling, and/or removal of the asset in question from its

location and in the restoration of that location. Any reductions in the price of acquisition reduce the acquisition costs. There was no revaluation of property, plant, and equipment on the basis of the provisions in IAS 16.

Grants from third parties reduce acquisition and production costs. Unless otherwise indicated, these grants (investment subsidies) are provided by government bodies.

Borrowing costs are not recognized as a part of acquisition or production cost, but are expensed as incurred.

Income grants that are not offset by future expenses are recognized as income.

The production cost of self-generated assets includes all the costs directly attributable to the production process, as well as appropriate parts of the production-related overheads.

If property, plant, and equipment are shut down, sold, or abandoned, the gain or loss from the difference between the sale proceeds and the residual carrying amount is recognized under other operating income or expenses. Assets relating to leases are also reported under property, plant, and equipment. Property, plant, and equipment hired by means of finance leases are recognized at fair value at their time of addition, unless the present values of the minimum lease payments are lower. The assets are depreciated regularly using the straight-line method over the expected useful life or the shorter contractual term.

The obligations resulting from future lease payments are recognized under financial liabilities.

The scheduled depreciation of property, plant, and equipment is generally carried out in accordance with the following useful lives:

in years	Useful life
Production buildings	20 to 40
Other buildings	10 to 30
Plant and machinery	6 to 12
Motor vehicles	4 to 6
Factory and office equipment	6 to 10

If the carrying amounts of intangible assets or items of property, plant, and equipment determined in accordance with the above principles are higher than their recoverable amounts as of the reporting date, corresponding impairment losses are recognized as an expense. The fair values are determined on the basis of the net selling price or, if higher,

the present value of the estimated future cash flows from the use of the asset. We use division-specific risk-adjusted interest rates in discounting those cash flows. For the group an average interest rate of 9.5% (previous year 8.8%) has been applied. The need for write-downs is assessed annually for such assets or groups of assets where there are indications of possible impairment. If the impairment loss no longer exists or has decreased, impairment losses are fully or partially reversed. Impairments are reported under other operating expenses, reversal of impairment losses under other operating income.

Investment property is measured according to the acquisition cost model.

Shares in non-consolidated subsidiaries and investments are measured at cost, unless divergent fair values are available.

Changes in market values are posted to the income statement upon realization by means of disposal or if the market value falls below the acquisition cost. Loans advanced are measured at amortized cost, except for non-interest-bearing and low-interest loans, which are measured at their present value.

Investments in associated companies and joint ventures are accounted for using the equity method. Generally the carrying amount reflects the Group's pro rata share of equity. In the process, pro rata net income is posted to the consolidated income statement and increases or decreases the carrying amount. Any changes in the investee's equity that have been recognized directly in the investee's equity are also recognized directly in equity in the consolidated financial statements. Dividends paid by joint ventures and associated companies reduce their equity and, therefore, decrease the carrying amount without affecting profit. If an associated company or a joint venture faces losses that have exhausted its equity, these losses are written off in full in the consolidated balance sheet. Any additional losses above and beyond additional assets of a type similar to the investments are not included in the consolidated financial statements. The carrying amount is not increased until the loss carryforward has been set off and the equity is positive again.

Inventories are measured at cost using the average cost method. Lower net disposal values or net realizable prices as of the balance sheet date are taken into account by means of write-downs to their fair value less selling costs. Production costs include directly attributable costs, appropriate parts of the indirect materials and indirect labor costs, and straight-line depreciation. Borrowing costs are not stated as part of acquisition and production costs. The overhead cost markups are determined on the basis of average capacity utilization.

Write-downs are recognized for inventory risks resulting from extended periods of storage and reduced usability and to reflect other reductions in the recoverable amount. In the income statement, the cost of unused production capacity is also included in the production costs.

For production-related reasons, work in process and finished goods are reported combined under products.

A financial instrument is a contract that gives rise to a financial asset of one entity and a financial liability or equity instrument of another entity. WACKER's financial assets include, in particular, cash and cash equivalents, trade receivables, and other receivables and derivative financial assets. Financial liabilities regularly substantiate claims for repayment in cash or another financial asset. This includes, in particular, bonds and other securitized liabilities, trade payables, amounts owed to banks, finance lease payables, promissory notes, and derivative financial liabilities. Financial instruments are generally recognized as soon as WACKER becomes party to the contractual regulations of the financial instrument. In the case of purchase or sale on usual market terms (purchase or sale within the framework of a contract of which the terms require delivery within the timeframe generally established by regulations or conventions prevailing on the market in question), however, the settlement date is relevant to the initial recognition or derecognition. This is the date on which the asset is delivered to or by WACKER. In general, financial assets and financial liabilities are not netted out. A net amount is presented in the balance sheet when, and only when, the entity currently has a right to set off the recognized amounts and intends to settle on a net basis.

Financial assets are measured at fair value when first recognized. In the process, the transaction costs directly attributable to the acquisition are taken into account for all financial assets not subsequently measured at fair value through profit and loss. The fair values recognized in the balance sheet generally correspond to the market prices of the financial assets. If these are not immediately available, they must be calculated using standard valuation models on the basis of current market parameters. Financial assets and liabilities are subsequently valued in accordance with the category – cash and cash equivalents, available-for-sale financial assets, loans and receivables, or financial liabilities recognized at amortized cost – to which they are allocated.

Trade receivables and other assets, including tax receivables, are basically recognized at amortized cost, except for derivative financial instruments. Risks are taken into account through appropriate depreciation posted as valuation allowances. Allowances for uninsured receivables – or for the deductible in the case of insured receivables – are made whenever recourse is had to the law. If an incoming receivable is no longer expected, even though an appeal has been lodged, the gross receivable is written off and the allowances made are reversed. Long-term receivables which are non-interest-bearing or low-interest are discounted. WACKER is not a contractor for long-term production orders.

Receivables from finance lease agreements where WACKER acts as the lessor are reported under other assets. In the process, the gross value of the outstanding lease payments, less the still unrealized borrowed amounts, is capitalized as a receivable. The lease installments received are apportioned into the respective interest amount and the repayment of the outstanding receivable in such a way that the interest amount reflects the constant interest-bearing of the still unsettled receivable. The interest amount is reported in the income statement under other financial results.

Available-for-sale financial assets – investments in current securities, equity instruments, debt instruments, and investment fund shares are classified as available-for-sale financial assets. They are recognized at fair value, provided that this value can be calculated reliably. In the process, observable market prices are used for orientation. Unrealized gains and losses are recorded taking account of deferred taxes and are recognized in other equity with no effect on income. If equity instruments have no price quoted on an active market and if their fair value cannot be determined reliably, they are measured at cost. If the fair values of available-for-sale financial assets fall below the acquisition costs and there are objective signs that an asset's value has been impaired, the cumulative loss recorded directly in equity is reversed and shown in the income statement. The company bases its assessment of possible impairments on all available information, such as market conditions and prices, investment-specific factors, and the duration and extent of the drop in value below acquisition costs. Impairments affecting a debt instrument are reversed in subsequent periods, provided that the reasons for the impairment no longer apply.

Derivative financial instruments are used for hedging purposes with the sole aim of reducing the Group's exposure to exchange rate, interest rate, and raw materials price risks arising from operating activities and the resultant financing requirements. Derivative financial instruments are always measured at fair value, irrespective of the purpose or intention for which they were concluded. Positive fair values are recognized as a receivable and negative current values as a liability. Changes in market values of financial instruments used to limit the risk of lower future inflows or higher outflows (cash flow hedges) are recognized in other comprehensive income in consideration of any related tax effects.

Measures to hedge the risk of changes in the market values of recognized assets or liabilities lead to "fair value hedges." Changes in fair values are recorded for both the hedged underlying transaction and the derivative financial instruments used for hedging, and these changes are presented in the income statement under "Other financial result." Derivative financial instruments are recorded as of the trading date.

Cash and cash equivalents, including cash accounts and current investments with banks, generally have a residual period of up to three months upon their addition and are measured at cost, which is equivalent to their nominal value.

Financial liabilities are measured at fair value on initial recognition. For all financial liabilities not subsequently measured at fair value through profit or loss, the transaction costs directly attributable to the acquisition are likewise taken into account. Liabilities from finance lease agreements are shown as financial liabilities at the present value of the future lease installments.

Trade payables and other liabilities (including tax liabilities) are basically recognized at amortized cost using the effective interest method.

There are no contingencies recorded in the balance sheet.

Deferred tax assets and liabilities are formed for temporary differences between tax bases and carrying amounts, as well as for consolidation measures recognized in the income statement. The deferred tax assets include tax relief entitlements resulting from the anticipated use of existing loss carryforwards in future years, the realization of which is assured with sufficient probability. The deferred taxes are determined on the basis of the tax rates which, under current law, are applicable or anticipated at the time of realization in the individual countries. The deferred tax assets and liabilities are netted out only to the extent that is possible under the same tax authority.

Minority shares in the limited partnership capital of consolidated companies are reported as a financial liability. Pro rata results and dividend payments increase or diminish this liability.

Pension provisions are measured according to the projected unit credit method. This method takes account not only of pensions and entitlements to future pensions known as of the balance sheet date, but also of estimated increases in salaries and pensions. The calculation is based on actuarial valuations, taking account of biometric calculation principles.

Actuarial gains and losses are recognized as income or expenses only once they move outside a margin of ten percent of the present value of the defined benefit obligation. In the event of this happening, the excess amounts are distributed over the average future residual working lives of the employees. The expense incurred in funding the pension provisions (service costs) is allocated to the costs of the functional areas concerned. The interest costs are reported under "Other financial result." If assets are funded externally (plan assets) to finance pension obligations, the fair values of these assets are set off against the present value of the obligations. The expected return on plan assets is likewise reported under "Other financial result."

Provisions are formed in the balance sheet for current legal or constructive obligations if an outflow of resources to cover these obligations is probable and the amount of these obligations can be estimated reliably. The assigned value of the provisions is based on the amounts that will be required to cover future payment obligations, identifiable risks, and Group contingencies. All cost components which are also capitalized under inventories are basically included in the measurement of other provisions. Noncurrent provisions are measured at discounted present value as of the balance sheet date. Any expected refunds, provided that they are sufficiently secure or legally enforceable, are not balanced against provisions.

Emission certificates allotted free of charge are measured at a nominal value of zero. Provisions are formed if the available portfolio of emission certificates does not cover the anticipated obligations. Proceeds from the sale of emission certificates allotted free of charge are included under other operating income.

Changes in the Accounting Methods/ Standards Used for the First Time

IAS 1: "Presentation of Financial Statements"

In September 2007, the IASB adopted changes to IAS 1. The revisions to the standard must be applied for the first time in the fiscal year which begins on or after January 1, 2009. Their earlier application is permissible. The revised standard was endorsed by the European Union in December 2008. Its first-time application will lead to the following significant changes in the way the financial statements are presented:

- Statement of comprehensive income: the presentation of all the changes in equity recorded in the reporting period (excluding transactions with shareholders) is made in two separate parts of the financial statements: additional to the income statement, those changes in assets and liabilities posted to equity which do not influence the result for the period are reported in the statement of comprehensive income. These include, in particular, the reporting of particular changes in the market values of derivative financial instruments in connection with the hedging of future payments in foreign currencies, and the change in the balancing item from the translation of consolidated companies' financial statements in foreign currencies. The statement of comprehensive income takes the result for the year and, via the aforementioned item, ascertains the total income and expenses reported, or "comprehensive income". Both the result for the year and the comprehensive income are apportioned to the shares attributable to minority interests and those accounted for by the shareholders in Wacker Chemie AG.
- Statement of changes in equity: the income and expenses posted directly to equity are reported as a single amount and no longer separately. The development of the other equity items is presented in detail in an additional table, where the individual items (foreign currency translation, cash flow hedging) are reported separately. This table is an integral part of the statement of changes in equity. In connection with this, the items "translation adjustment" and "Gains and losses recognized in equity", which were previously reported separately in the balance sheet, are now combined in the single item "Sundry equity items".

IAS 39: "Financial Instruments: Recognition and Measurement" and IFRS 7:

"Financial Instruments: Disclosures"

In October 2008, the IASB adopted changes to the two standards specified above which must be applied retroactively as from July 1. They have been endorsed by the European Union, also in October 2008. Due to a lack of relevant data, the application of the revised standards did not have any impact on Wacker Chemie AG's consolidated financial statements.

IFRIC 11: “IFRS 2-Group and Treasury Share Transactions”

This interpretation must be used for the first time in the fiscal year that begins on or after March 1, 2007. The interpretation was endorsed by the European Union on June 1, 2007. As there are no relevant transactions in the WACKER Group, the application of the interpretation has no impact on Wacker Chemie AG’s consolidated financial statements.

IFRIC 14: “IAS 19-The Limit on a Defined Benefit Asset, Minimum Funding Requirements and Their Interaction”

The first mandatory application of this interpretation is in the fiscal year beginning on or after January 1, 2008. The changes were endorsed by the European Union on December 16, 2008. In view of the application of the IAS 19 rules so far, its application has no impact on Wacker Chemie AG’s consolidated financial statements.

01 Sales/Functional Costs/Other Operating Income/Other Operating Expenses

Sales

€ million	2008	2007
Sales from deliveries of products and merchandise	4,212.7	3,677.5
Sales from other services	85.4	103.8
	4,298.1	3,781.3

Production Costs

€ million	2008	2007
Impairments of inventories included in cost of sales	7.5	–

Other Operating Income

€ million	2008	2007
Gains from currency transactions	281.7	88.8
Income from reversal of provisions	12.6	7.4
Insurance compensation	4.2	1.5
Income from reversal of valuation allowances for receivables	1.0	0.5
Gains from disposal of assets	15.5	2.4
Subsidies/grants	3.7	4.3
Income from badwill	14.3	–
Other	11.6	11.5
	344.6	116.4

Other Operating Expenses

€ million	2008	2007
Losses from currency transactions	– 258.2	– 78.6
Losses from valuation allowances for receivables	– 22.8	– 2.3
Losses from disposal of assets/impairment of property, plant, and equipment	– 33.7	– 19.1
Impairment of goodwill	–	– 7.7
Restructuring measures/project costs	– 1.1	–
Other	– 5.2	– 29.4
	– 321.0	– 137.1

The other operating expenses include expenses not attributable to functional costs.

In the Siltronic segment, property, plant, and equipment – mainly located in the United States and in Japan – of €22.2 million has been impaired. Those assets consist of machinery and buildings and belong to product lines with estimated discounted cash flows being below the carrying amounts. The estimated lower realizable cash flows are related to the global economic crisis impacting Siltronic's customers and thus the future orders for Siltronic's products.

As a result of knowledge gained in the course of the integration regarding the associated production facilities at the U.S. locations, the Executive Board of Wacker Chemie AG decided to close the production facility in South Brunswick, New Jersey in 2009. This resulted in asset impairment of €5.5 million.

During the fourth quarter WACKER's executive board decided to close the site operated by Wacker Polymer Systems (WUXI) Co. Ltd. in Wuxi, China, at the end of fiscal 2010. The reduction of expected cash inflows after that date lead to a lower value in use and consequently to an impairment loss of €2.5 million.

In the previous year, impairment losses mainly impacted the assets of the WACKER POLYMERS, WACKER FINE CHEMICALS, and Siltronic segments. In the WACKER POLYMERS segment, PVB (polyvinyl butyral) activities were supposed to cease by the end of the 2008 fiscal year. The impairment losses related to the remaining assets of €8.9 million.

In the course of a restructuring program that started in 2006, the WACKER FINE CHEMICALS segment discontinued its ester/ketene activities as from the start of fiscal 2008. The impairment losses related to the remaining assets of €4.8 million.

In both cases, the impairment losses were recorded on the basis of the lower value in use. As the period until the shutdown of the property, plant, and equipment concerned was short, the calculated cash flows were not discounted.

In the Siltronic segment, machinery was shut down due to production-related restructuring measures. There were no positive net realizable values or values in use. The impairment loss totaled €2.5 million. Amortization of goodwill in the previous year related to the acquisition of the biotechnology business of the former Prothera GmbH in fiscal 2005 (WACKER FINE CHEMICALS segment). The expected cash flow is based on planned figures.

The goodwill impairment test has been based on a ten-year planning period that takes account of the special nature of the biotechnology business. The key indicators included anticipated sales, personnel expenses, and cost of materials. The experience gained from completed test periods has been taken into consideration. The discount rate was 6.9%.

02 Income From Investments in Joint Ventures and Associates/Other Income from Participations/Net Interest Income/Other Financial Results/Limited Partnerships Interests

€ million	2008	2007
Income from investments in joint ventures and associates¹	- 33.7	- 9.3
of which pro-rata result attributable to joint ventures	- 23.4	- 3.2
Other income from participations		
Income from participations ²	0.4	8.2
Other income from participations	-	0.1
Impairment of participations	- 0.1	- 0.6
	0.3	7.7
Net interest income		
Interest and similar income	17.3	14.6
of which from financial instruments available for sale	1.9	0.3
of which from financial instruments held to maturity	8.0	5.8
Interest and similar expenses	- 11.6	- 15.6
	5.7	- 1.0
Other financial results		
Other financial income	0.2	1.1
Interest effect of noncurrent provisions/liabilities/finance lease	- 7.2	- 1.3
Other financial expenses	- 3.9	- 1.0
	- 10.9	- 1.2
Limited partnership interests³	- 0.9	- 15.3

¹The income from investments in joint ventures and associates relates mainly to companies in Germany, the USA, China, and Singapore. This income includes not only the pro rata shares of net results, but also sums from the reversal of differences between the acquisition cost of the investment and the proportion of equity at the time of acquisition, as well as effects from pro rata eliminations of intercompany profits.

²The income from participations in the previous year relates mainly to investments in companies in the USA.

³In the WACKER Group, partnerships in which minority shareholders have interests were consolidated as of January 31, 2008. The proportion of respective partnerships' net income due to these minority shareholders is shown under this item. In the balance sheet, the minority shareholders' proportion of the equity in these partnerships is presented separately as noncurrent debt.

03 Income Taxes

The calculation is based on the current legal position in the individual countries regarding applicable or anticipated tax rates as of the realization date. These are generally based on the legal stipulations valid or adopted as of the balance sheet date.

In Germany, a solidarity surcharge is added to corporation tax. In addition, there is trade income tax to be paid. This varies depending on the municipality in which the company is located. Trade income tax was a deductible operating expense up to and including the 2007 taxable period.

Tax Rates in Germany

%	2008	2007
Weighted average trade income tax rate	12.0	14.7
Corporation tax rate	15.0	25.0
Solidarity surcharge	5.5	5.5

The income from foreign Group companies is subject to taxation at the tax rates valid in the country where the respective company is located. No deferred taxes on undistributed profits of subsidiaries were recognized. It was decided not to determine the possible resulting tax effects as the time and expense involved was unreasonably high. €596.2 million (2007: €567.5 million) is available for distribution.

€ million	2008	2007
Current taxes	- 200.3	- 192.8
Deferred taxes	- 3.2	- 17.1
Income taxes	- 203.5	- 209.9
Derivation of the effective tax rate		
Earnings before taxes	641.8	632.1
Income tax rate for Wacker Chemie AG	% 28.5	38.0
Expected tax expenses	- 182.9	- 240.2
Tax rate divergences	- 12.8	5.2
Tax effect of non-deductible expenses	- 2.3	- 5.7
Tax effect of tax-free income	8.8	11.8
Taxes relating to other periods (current earnings)	- 10.2	- 10.4
Change in the valuation allowances for deferred tax assets	- 7.0	30.6
Taxes attributable to minority shareholders	- 0.3	- 5.8
Effect of changes in tax legislation	- 3.9	10.6
Group equity result	- 10.1	- 3.8
Effect from supplementary tax balance sheets	18.5	-
Other divergences	- 1.3	- 2.2
Total income tax	- 203.5	- 209.9
Effective tax rate	% 31.7	33.2

The effect from the supplementary tax balance sheets results from the acquisition of the remaining shares in the WPS partnerships.

When deferred taxes were calculated for the Group's German-based corporate entities, the change in German tax legislation effective from 2008 was taken into account. The result of this change is to reduce the German income tax rate to around 30%.

In 2007, the change in valuation allowances for deferred tax assets mainly impacts the tax effect from the sale of Wacker NSCE Malaysia at Siltronic Japan Corporation. This made it possible to realize the temporary difference arising from the valuation principles.

Allocation of Deferred Taxes

€ million	2008		2007	
	Deferred tax assets	Deferred tax liabilities	Deferred tax assets	Deferred tax liabilities
Intangible assets	14.4	–	1.9	–
Property, plant, and equipment	4.2	94.8	1.9	84.2
Current assets	9.7	13.6	7.4	10.2
Pension provisions	7.9	2.0	10.3	–
Other provisions	44.0	20.9	36.5	12.4
Liabilities	31.7	0.1	21.3	–
Loss carryforwards	0.1	–	0.1	–
Tax credits	0.2	1.1	–	–
	112.2	132.5	79.4	106.8
Setoffs	– 81.0	– 81.0	– 66.4	– 66.4
Balance sheet item	31.2	51.5	13.0	40.4

The change in deferred tax assets and liabilities has been recognized in profit or loss with €–3.2 million (previous year €–17.1 million) and charged or credited directly to equity with €10.3 million (previous year €–4.5 million).

The existing tax loss carryforwards can still be used as follows:

€ million	2008	2007
Within 1 year	0.9	0.8
Within 2 years	1.3	1.0
Within 3 years	2.4	1.1
Within 4 years	6.9	2.2
Within 5 years or later	15.9	7.1
	27.4	12.2
Of which loss carryforwards not expected to be realizable	– 27.1	– 10.9
Of which loss carryforwards expected to be realizable	0.3	1.3

04 Development of Fixed Assets

€ million	Intangible assets	Property, plant, and equipment	Investment property	Investments in joint ventures and associates	Financial assets	Total
Cost						
Balance as of Jan. 1, 2007	238.0	6,342.6	45.4	98.3	66.7	6,791.0
Additions	5.6	572.9	–	114.3	6.5	699.3
Disposals	–123.6	–113.8	–	–	–0.4	–237.8
Transfers	1.8	31.8	–33.6	–	–	–
Other changes ¹	–	–	–	–9.7	–	–9.7
Exchange rate differences	–1.7	–100.7	–	–6.7	–	–109.1
Balance as of Dec. 31, 2007	120.1	6,732.8	11.8	196.2	72.8	7,133.7
Depreciation/amortization						
Balance as of Jan. 1, 2007	221.7	4,425.0	43.9	–	1.5	4,692.1
Additions	5.2	321.4	–	–	0.6	327.2
Impairment	7.7	17.0	–	–	–	24.7
Disposals	–123.6	–110.4	–	–	–	–234.0
Transfers	0.4	33.2	–33.6	–	–	–
Exchange rate differences	–1.4	–76.8	–	–	–	–78.2
Balance as of Dec. 31, 2007	110.0	4,609.4	10.3	–	2.1	4,731.8
Net carrying amounts as of Dec. 31, 2007	10.1	2,123.4	1.5	196.2	70.7	2,401.9
Reduction in cost due to investment grant	–	–	–	–	–	328.2

¹ For companies accounted for using the equity method, this item includes the change resulting from the application of the equity method.

€ million	Intangible assets	Property, plant, and equipment	Investment property	Investments in joint ventures and associates	Financial assets	Total
Cost						
Balance as of Jan. 1, 2008	120.1	6,732.8	11.8	196.2	72.8	7,133.7
Additions	9.9	814.2	2.3	26.2	63.7	916.3
Disposals	-15.1	-94.6	-	-2.2	-0.2	-112.1
Transfers	2.8	-2.8	-	-	-	-
Changes in the scope of consolidation	8.1	108.6	-	-2.8	-62.1	51.8
Other changes ¹	-	-	-	-36.2	-	-36.2
Exchange rate differences	4.2	148.8	-	10.6	0.4	164.0
Balance as of Dec. 31, 2008	130.0	7,707.0	14.1	191.8	74.6	8,117.5
Depreciation						
Balance as of Jan. 1, 2008	110.0	4,609.4	10.3	-	2.1	4,731.8
Additions	7.4	369.4	0.2	-	0.1	377.1
Impairment	0.4	29.8	-	-	-	30.2
Disposals	-15.1	-84.3	-	-	-	-99.4
Changes in the scope of consolidation	-	9.5	-	-	-	9.5
Exchange rate differences	2.6	113.6	-	-	0.4	116.6
Balance as of Dec. 31, 2008	105.3	5,047.4	10.5	-	2.6	5,165.8
Net carrying amounts as of Dec. 31, 2008	24.7	2,659.6	3.6	191.8	72.0	2,951.7
Reduction in cost due to investment grant	-	-	-	-	-	340.9

¹ For companies accounted for using the equity method, this item includes the change resulting from the application of the equity method.

05 Intangible Assets

€ million	Industrial property rights and similar rights and assets	Goodwill	Total
Cost			
Balance as of Jan. 1, 2007	108.1	129.9	238.0
Additions	4.4	1.2	5.6
Disposals	-0.2	-123.4	-123.6
Transfers	1.8	-	1.8
Exchange rate differences	-1.6	-0.1	-1.7
Balance as of Dec. 31, 2007	112.5	7.6	120.1
Amortization			
Balance as of Jan. 1, 2007	98.3	123.4	221.7
Additions	5.2	-	5.2
Impairment	-	7.7	7.7
Disposals	-0.2	-123.4	-123.6
Transfers	0.4	-	0.4
Exchange rate differences	-1.3	-0.1	-1.4
Balance as of Dec. 31, 2007	102.4	7.6	110.0
Net carrying amounts as of Dec. 31, 2007	10.1	-	10.1

€ million	Industrial property rights and similar rights and assets	Goodwill	Total
Cost			
Balance as of Jan. 1, 2008	112.5	7.6	120.1
Additions	9.9	–	9.9
Disposals	– 15.1	–	– 15.1
Transfers	2.8	–	2.8
Changes in the scope of consolidation	8.1	–	8.1
Exchange rate differences	4.1	0.1	4.2
Balance as of Dec. 31, 2008	122.3	7.7	130.0
Amortization			
Balance as of Jan. 1, 2008	102.4	7.6	110.0
Additions	7.4	–	7.4
Impairment	0.4	–	0.4
Disposals	– 15.1	–	– 15.1
Exchange rate differences	2.5	0.1	2.6
Balance as of Dec. 31, 2008	97.6	7.7	105.3
Net carrying amounts as of Dec. 31, 2008	24.7	–	24.7

This item presents separately acquired intangible assets. The additions to industrial property rights relate to operating activities.

In the fiscal year, intangible assets amounting to €8.1 million were identified within the purchase price allocation as part of the extension of the scope of consolidation through the acquisition of the shares in the APP companies; these consist primarily of customer lists.

The addition to goodwill in the previous period relates to a subsequent purchase price obligation arising from the acquisition of Wacker Biotech GmbH.

In the previous year, amortized goodwill resulting from the acquisition of subsidiaries that could no longer be allocated was reported under disposals. The goodwill in question came into being at least 7 years ago.

06 Property, Plant, and Equipment

€ million	Land, buildings, and similar rights	Technical equipment and machinery	Other equipment, factory and office equipment	Assets under construction	Total
Cost					
Balance as of Jan. 1, 2007	1,050.0	4,535.5	500.1	257.0	6,342.6
Additions	48.0	197.4	33.8	293.7	572.9
Disposals	-13.4	-82.9	-18.1	0.6	-113.8
Transfers	3.8	212.1	9.5	-193.6	31.8
Exchange rate differences	-25.1	-70.4	-2.1	-3.1	-100.7
Balance as of Dec. 31, 2007	1,063.3	4,791.7	523.2	354.6	6,732.8
Depreciation					
Balance as of Jan. 1, 2007	616.2	3,398.1	410.7	-	4,425.0
Additions	36.9	253.2	31.3	-	321.4
Impairment	3.1	13.5	0.4	-	17.0
Disposals	-10.9	-81.9	-17.6	-	-110.4
Transfers	-4.4	36.6	1.0	-	33.2
Exchange rate differences	-13.5	-61.4	-1.9	-	-76.8
Balance as of Dec. 31, 2007	627.4	3,558.1	423.9	-	4,609.4
Net carrying amounts as of Dec. 31, 2007	435.9	1,233.6	99.3	354.6	2,123.4
Of which assets from financial leases					
Gross carrying amounts	89.7	49.2	0.1	-	139.0
Depreciation	-72.6	-18.0	-	-	-90.6
Net carrying amounts	17.1	31.2	0.1	-	48.4

€ million	Land, buildings, and similar rights	Technical equipment and machinery	Other equipment, factory and office equipment	Assets under construction	Total
Cost					
Balance as of Jan. 1, 2008	1,063.3	4,791.7	523.2	354.6	6,732.8
Additions	64.1	282.7	35.6	431.8	814.2
Disposals	- 7.5	- 57.6	- 24.8	- 4.7	- 94.6
Transfers	35.7	280.2	4.0	- 322.7	- 2.8
Changes in the scope of consolidation	24.7	80.5	1.8	1.6	108.6
Exchange rate differences	40.1	103.4	1.4	3.9	148.8
Balance as of Dec. 31, 2008	1,220.4	5,480.9	541.2	464.5	7,707.0
Depreciation					
Balance as of Jan. 1, 2008	627.4	3,558.1	423.9	-	4,609.4
Additions	39.4	296.5	33.4	0.1	369.4
Impairment	17.8	12.0	-	-	29.8
Disposals	- 6.7	- 53.5	- 24.1	-	- 84.3
Transfers	- 4.4	12.6	- 8.2	-	-
Changes in the scope of consolidation	0.8	7.4	1.3	-	9.5
Exchange rate differences	22.4	89.9	1.3	-	113.6
Balance as of Dec. 31, 2008	696.7	3,923.0	427.6	0.1	5,047.4
Net carrying amounts as of Dec. 31, 2008	523.7	1,557.9	113.6	464.4	2,659.6
Of which assets from financial leases					
Gross carrying amounts	89.7	49.2	0.1	-	139.0
Depreciation	- 77.1	- 21.6	-	-	- 98.7
Net carrying amounts	12.6	27.6	0.1	-	40.3

07 Investment Property

The designation of the items was adjusted to the official designation in accordance with the German translation of the IFRS by the EU. In connection with this, the historical cost and accumulated depreciation regarding the amounts from the previous year were reclassified to the appropriate asset categories, insofar as they related to assets that did not concern land and buildings. The net carrying amounts for these assets as of January 1, 2007 were zero.

Wacker Chemie AG owns real estate at its former production site in Cologne, Germany. The real estate in question is comprised of land and infrastructural facilities (energy, waste water, etc.). The land is rented out or on long-term leases. There is no finance lease. This real estate is subject to the same principles regarding depreciation method and useful life as assets that we use for our own purposes. This land and infrastructure in Cologne is operated, maintained, and looked after by third parties who charge any costs incurred directly to the tenants or leaseholders.

In addition, Wacker Chemie AG purchased sections of the Wacker Burghausen Fußball GmbH stadium. This led to a fixed asset addition of €2.3 million. The stadium was leased to Wacker Burghausen Fußball GmbH. The lease term encompasses the period from July 1, 2008 to June 30, 2011. The lease income is included in the following schedule.

€ million	2008	2007
Fair value	15.9	13.8
Income from rent/operating leases	1.0	1.4
Costs	- 0.2	- 0.3

The fair value is based on our own estimates. It is reviewed by external experts every three to four years.

08 Investments in Joint Ventures and Associates/Financial Assets

€ million	Investments in joint ven- tures and associates	Other investments	Other financial assets	Financial assets
Cost				
Balance as of Jan. 1, 2007	98.3	64.3	2.4	66.7
Additions	114.3	6.4	0.1	6.5
Disposals	-	-	-0.4	-0.4
Changes in the scope of consolidation	-9.7	-	-	-
Exchange rate differences	-6.7	-	-	-
Balance as of Dec. 31, 2007	196.2	70.7	2.1	72.8
Write-downs				
Balance as of Jan. 1, 2007	-	1.5	-	1.5
Additions	-	0.6	-	0.6
Balance as of Dec. 31, 2007	-	2.1	-	2.1
Net carrying amounts as of Dec. 31, 2007	196.2	68.6	2.1	70.7
Cost				
Balance as of Jan. 1, 2008	196.2	70.7	2.1	72.8
Additions	26.2	3.4	60.3	63.7
Disposals	-2.2	-	-0.2	-0.2
Changes in the scope of consolidation	-2.8	-62.1	-	-62.1
Changes resulting from application of equity method	-36.2	-	-	-
Exchange rate differences	10.6	0.4	-	0.4
Balance as of Dec. 31, 2008	191.8	12.4	62.2	74.6
Write-downs				
Balance as of Jan. 1, 2008	-	2.1	-	2.1
Additions	-	0.1	-	0.1
Exchange rate differences	-	0.4	-	0.4
Balance as of Dec. 31, 2008	-	2.6	-	2.6
Net carrying amounts as of Dec. 31, 2008	191.8	9.8	62.2	72.0

The change in the carrying amounts of the investments resulting from changes in the scope of consolidation relate to the shares hitherto held in the APP companies. In the course of the acquisition of the remaining shares, the corresponding investments were disposed of on the basis of full consolidation.

The previous year's additions of joint ventures and associates consolidated at equity relate mainly to our investment in Dow Corning (Zjg) Holding Pte. Ltd., Singapore. In December, additionally, a shareholder loan amounting to €60.3 million was granted under usual terms and conditions to Siltronic Samsung Wafer Pte. Ltd., Singapore. The addition is reported under other financial investments.

The loan was part of an agreement signed as of December 23, 2008 about granting a shareholder loan. In addition to the payment of interest and the settlement of the loan, Siltronic AG has been granted the right to convert the loan into equity (call option). The exercise period for this option starts on January 1, 2010 and ends on December 31, 2012.

The previous year's additions of joint ventures and associates consolidated at equity relate mainly to our investment in Siltronic Samsung Wafer Pte. Ltd., Singapore and our investment in WACKER SCHOTT Solar GmbH, Jena, Germany.

For more financial information on associated companies and joint ventures. → See Note 23

09 Inventories

€ million	2008	2007
Raw materials and supplies	159.1	115.2
Products	314.8	264.0
Merchandise	28.6	21.3
Performances not charged	1.1	2.1
Advance payments	1.3	0.9
	504.9	403.5
Of which recorded at fair value less selling expenses	89.7	84.0

10 Accounts Receivable/Other Assets/Tax Receivables

€ million	2008			2007		
	Total	Of which noncurrent	Of which current	Total	Of which noncurrent	Of which current
Trade receivables	466.8	–	466.8	461.4	0.8	460.6
Of which noncurrent, falling due in > 5 years	–	–	–	–	–	–
Other receivables from associated companies	8.3	–	8.3	7.4	–	7.4
Payments made on account to associated companies	72.7	70.4	2.3	–	–	–
Loan and interest receivables	3.0	–	3.0	0.9	–	0.9
Derivative financial instruments	52.2	20.1	32.1	57.7	12.1	45.6
Prepaid expenses and deferred charges	55.3	42.8	12.5	35.4	24.2	11.2
Investment fund shares ¹	30.7	30.7	–	22.7	22.4	0.3
Claims arising from investment grants	21.4	–	21.4	60.5	0.1	60.4
Sundry assets	19.0	0.2	18.8	10.9	0.3	10.6
Other assets	262.6	164.2	98.4	195.5	59.1	136.4
Of which noncurrent, falling due in > 5 years	–	47.1	–	–	10.6	–
Tax receivables	102.6	13.9	88.7	76.3	15.8	60.5
Of which noncurrent, falling due in > 5 years	–	7.6	–	–	9.6	–

¹The investment fund shares for securing semi-retirement obligations are classified as available for sale. Their market value amounts to € 30.7 million (2007: 22.3 million). These fund shares are traded on active markets and pledged individually to employees participating in the semi-retirement program.

The payments made on account to associated companies were made for future deliveries of solar wafers from WACKER SCHOTT Solar Vertriebs GmbH to the joint venture WACKER SCHOTT Solar GmbH.

Accounts receivable are shown at amortized cost, which corresponds to their fair values. Default risks – if not covered by insurance – are taken into account with adequate valuation allowances. Prepaid expenses and deferred charges are mainly comprised of capitalized VAT for advance payments received.

Other receivables from associated companies contain for the first time receivables from finance leases with €0.3 million. The related gross investment amounts to €1.0 million and is due in the course of one year with €0.1 million, between one and five years with €0.2 million and after five years with €0.7 million.

The present value of the minimum lease payments amounts to €0.3 million and is due after five years with €0.3 million.

The unearned noncurrent finance income amounts to €0.7 million.

Development of Valuation Allowances

€ million			2008			2007
	Trade receivables	Other assets	Total	Trade receivables	Other assets	Total
Balance on Jan. 1	4.8	0.3	5.1	5.2	0.2	5.4
Utilization	-0.9	-	-0.9	-0.8	-	-0.8
Addition/reversal	27.9	0.6	28.5	0.6	0.1	0.7
Exchange rate changes	-0.1	-	-0.1	-0.2	-	-0.2
Balance on Dec. 31	31.7	0.9	32.6	4.8	0.3	5.1
Overdue debts						
<= 30 days	59.7	0.1	59.8	42.3	0.1	42.4
> 31 <= 45 days	11.8	0.6	12.4	9.9	1.2	11.1
> 45 days	15.2	6.7	21.9	12.6	1.6	14.2
Total	86.7	7.4	94.1	64.8	2.9	67.7

Valuation allowances are set up in the event of identifiable credit risks and exchange rate fluctuations. The maximum default risk is equal to the carrying amount of the uninsured receivables. No loans or receivables were renegotiated to prevent an overdue debt or possible impairment. Based on past experience and on the conditions prevailing as of the balance sheet date, there are no restrictions with regard to credit quality.

The addition in the valuation allowances for receivables in the reporting year basically relates to companies in the Siltronic Group and Wacker Chemie AG.

11 Cash and Cash Equivalents (Liquid Assets)

€ million	2008	2007
Current securities	101.1	–
These are German federal government securities that fall due within one year, but are held for longer than three months. They are classified as available-for-sale.		
Cash and cash equivalents		
Commercial papers (cash equivalents)	49.5	238.6
Demand deposits, cash on hand (cash)	154.7	127.9
	204.2	366.5

Demand deposits and cash on hand are shown at their nominal values. Commercial papers are classified as “held to maturity.” They are commercial papers from issuers with first-class credit standing. They fall due after a maximum of three months.

12 Equity/Minority Interests

The subscribed capital (capital stock) of Wacker Chemie AG amounts to €260,763,000. It consists of 52,152,600 no-par-value shares (total). This corresponds to a computed par value of €5 per share. There are no different classes of shares. All of the shares are common shares.

In the course of the IPO in April 2006, the number of shares outstanding increased as a result of the sale of some shares previously held as treasury shares. The following table shows the development in the year under review and in the previous year:

Units	2008	2007
Shares outstanding at the start of the fiscal year	49,677,983	49,677,983
Shares outstanding at the end of the fiscal year	49,677,983	49,677,983
Treasury shares in portfolio	2,474,617	2,474,617
Total shares	52,152,600	52,152,600

For an explanation of Wacker Chemie AG's shareholder structure. → See Note 24

The capital reserve includes the amounts generated with share issues over and above their nominal values in previous years, as well as other contributions to equity made by shareholders.

Retained earnings include amounts formed in previous fiscal years at Wacker Chemie AG, transfers from the Group's earnings for the year, the earnings of the consolidated companies less amounts due to minority shareholders, changes to consolidated items affecting income, and changes in the scope of consolidation.

The remaining equity shows both the differences arising from the translation of foreign subsidiaries' financial statements having other reporting currencies than the Euro and the effects of the valuation of financial instruments also with no effect on income.

Net income attributable to minority shareholders is made up of the following profits and losses:

€ million	2008	2007
Profits	4.3	2.2
Losses	-5.4	-2.0
Net income attributable to minority shareholders	-1.1	0.2

As part of its capital management, Wacker Chemie AG complies with the legal stipulations on capital maintenance. The company is not subject to any capital requirements set down by its Articles of Incorporation. No special capital terminology is used.

13 Pension Provisions

WACKER Group employees can avail themselves of various post-employment pension plans, which depend on the legal, economic, and fiscal conditions prevailing in the respective countries. These pension plans generally take account of employees' length of service and salary levels.

The company pension plan makes a distinction between defined contribution and defined benefit plans. Defined contribution plans lead to no further obligation for the company beyond paying contributions into special-purpose funds. Pension obligations result additionally from defined benefit plans in the form of entitlements to future pensions and on-going payments for eligible active and former employees of the WACKER Group and their surviving dependents.

Employees in Germany have the option of converting part of their payout into direct benefit commitments. Benefit plans taken out by December 31, 2000 are measured (in accordance with the projected unit credit method) at the value of years' service to date/years served to retirement (pro rata temporis), whereas any benefit plans taken out on or after January 1, 2001 are measured at the present value of the defined benefit obligation. In view of their pension-like character, obligations relating to the medical care of retired employees (USA) and severance payments are likewise included under pension provisions.

Group companies have both defined contribution and defined benefit plans. They are financed on one hand by funds/Pensionskasse der Wacker Chemie VVaG, and on the other by provisions in the form of direct commitments.

The obligations from direct benefit plans are calculated using the projected unit credit method, which takes account of future payout and pension adjustments. The current service cost of pension benefit claimants results from the planned development of the provisions for expected future pension payments. Any differences between those pension obligations calculated as planned and the defined benefit obligation at year-end are treated as actuarial gains or losses and are spread over the average remaining service of the plan participants during the follow-up periods, insofar as these differences exceed 10% of the greater of the present value of the defined benefit obligation and the cash value of the plan assets. WACKER does not apply the right to recognise actuarial gains and losses in the period in which they occur directly in other comprehensive income. We don't judge that accounting policy a better faithful representation of the long term nature of pension liabilities.

In compliance with their respective national legislation, some relatively small foreign subsidiaries take on pension-related obligations arising from severance payments after the scheduled termination of employment. These obligations are likewise reported as pension provisions.

All of these obligations are financed only in part by means of provisions. Group pension obligations are financed to a considerable degree by externally invested plan assets. In

the case of both Wacker Chemie AG and the German Group companies, these assets are handled by Pensionskasse der Wacker Chemie VVaG.

The funding of Pensionskasse der Wacker Chemie VVaG by the German domestic Group companies is included in expenses for pensions. The pension obligations resulting from the application of the projected unit credit method are reduced by the fair value of the plan assets and by still unrecognized actuarial losses, or increased by still unrecognized actuarial gains. If the plan assets exceed the obligation from the pension commitment, an asset is generally recorded. It can, however, be capitalized only on the condition that the reporting entity can draw commercial benefits from these assets, e.g. in the form of refunds from the plan or reductions in future contributions to the plan ("asset ceiling" pursuant to IAS 19.58 ff.). As Pensionskasse der Wacker Chemie VVaG sets its contributions in the manner stipulated by supervisory bodies, there is no access to the surplus fund assets in Germany. Surplus amounts are therefore not capitalized. Unless the fund assets cover the obligation, the net obligation is shown as a liability under pension provisions.

Pension obligations in Germany are calculated in accordance with the biometric calculation principles based on Prof. Dr. Klaus Heubeck guideline tables from 2005. Pension obligations abroad are calculated in accordance with locally applicable principles and parameters. The calculations are based on actuarial valuations that take account of the following parameters:

Parameters

%	Germany		USA		Japan	
	2008	2007	2008	2007	2008	2007
Actuarial interest rate	5.75	5.50	6.00	6.00	2.25	2.25
Payment trend	3.00	3.00	3.5 / 3.0	3.00 / 3.50	–	–
Expected return on assets	5.25	6.00	7.5 / 8.0	7.50	–	–

The expected return on plan assets was estimated based on past trends and anticipated values for the following year. Interest income may vary in the fund's individual asset classes. The percentage rate chosen corresponds to the average rate of all asset types.

To arrive at the amount recognized as a defined benefit liability, the plan assets taken out in funds are balanced against the defined benefit obligation at year-end (financial status). Provisions for pensions are obtained after the actuarial profits and losses not yet recognized are deducted or added as appropriate.

€ million	Germany 2008	Foreign 2008	Total 2008	Total 2007
Change in defined benefit obligation (DBO)				
DBO Jan. 1	1,379.1	109.1	1,488.2	1,605.6
Service cost	31.9	3.9	35.8	42.4
Interest cost	74.3	6.6	80.9	71.7
Contributions by beneficiaries	9.5	0.2	9.7	9.6
Actuarial profits (-) and losses (+)	4.9	1.8	6.7	-173.2
Pension payments	-56.1	-3.9	-60.0	-55.7
Change in scope of consolidation	0.6	-	0.6	-
Exchange rate differences	-	7.0	7.0	-11.5
Other changes	-	-	-	-0.7
DBO Dec. 31	1,444.2	124.7	1,568.9	1,488.2
Change in fund assets				
Fund assets at present value Jan. 1	1,209.9	82.2	1,292.1	1,279.0
Return on fund assets	-100.2	-20.8	-121.0	41.3
Employer contributions	45.6	15.9	61.5	13.2
Contributions by beneficiaries	9.5	0.2	9.7	9.6
Pension payments	-40.9	-3.4	-44.3	-41.8
Exchange rate differences	-	3.5	3.5	-8.9
Other changes	-	-	-	-0.3
Fund assets at present value Dec. 31	1,123.9	77.6	1,201.5	1,292.1
Financial status				
Actuarial profits/losses still unrecognized	-36.7	-33.3	-70.0	-28.6
Asset ceiling (IAS 19.58 ff.)	75.7	-	75.7	200.2
Similar obligations	1.1	1.9	3.0	1.5
Pension provisions	360.4	15.7	376.1	369.2
Extent to which provisions financed the DBO	396.0	47.1	443.1	396.3
Of which German-based companies in 2007				369.4
Of which foreign subsidiaries in 2007				26.9

The pension expenses incurred as a result of defined benefit plans and the sum total of all pension expenses consist of the following:

€ million	2008	2007
Service cost	- 35.8	- 42.2
Interest cost	- 80.9	- 71.7
Expected return on fund assets	79.4	76.6
Amortization of actuarial profits and losses	- 169.5	105.7
"Asset ceiling" effect	124.5	- 111.9
Plan curtailments and settlements	-	- 0.6
Other	0.5	- 0.4
Pension expenses from defined benefit plans	- 81.8	- 44.5
Pension expenses from defined contribution plans	- 3.6	- 1.3
Other pension expenses	4.2	- 2.3
Pension expenses	- 81.2	- 48.1
Contributions to state pension plans	- 52.1	- 51.3
Expenses for post-employment benefits	- 133.3	- 99.4
Of which included in personnel expenses (functional costs)	- 131.8	- 104.3
Of which included in other financial result	- 1.5	4.9

Deviations between the obligations and the plan assets due to the assumptions and the actual developments:

€ million	2008	2007	2006	2005
Projected benefit obligation	1,568.9	1,488.2	1,605.6	1,626.0
Experience-based adjustments contained therein	- 206.7	12.6	- 12.3	- 14.7
Fund assets	1,201.5	1,292.1	1,279.0	1,208.1
Experience-based contained therein	186.8	34.3	- 7.1	- 81.8
Financing status	367.4	196.1	326.6	417.9

In 2009, we expect contributions to plan assets to amount to €24.6 million.

Composition of the Plan Assets

%	2008			2007		
	Total	Of which third parties	Of which group ¹	Total	Of which third parties	Of which group ¹
Real estate	16.9	11.8	5.1	16.8	11.6	5.2
Loans/fixed-interest securities	47.7	47.7	–	38.5	38.5	–
Shares/funds ²	34.4	34.4	–	38.8	38.8	–
Cash and cash equivalents	1.0	1.0	–	5.9	5.9	–
Total	100.0	94.9	5.1	100.0	94.8	5.2

¹ Items posted here are used by Group companies.

² The Pensionskasse der Wacker Chemie VVaG has agreed with an investment company upon an arrangement approved by the German Bundesanstalt für Finanzdienstleistungsaufsicht (BaFin) which implies compensation for any fluctuation of share prices relating to the Pensionskasse's stock of shares.

14 Other Provisions/Tax Provisions

€ million	2008			2007		
	Total	Of which noncurrent	Of which current	Total	Of which noncurrent	Of which current
Personnel	114.0	111.7	2.3	101.7	97.1	4.6
Sales/purchasing	7.1	–	7.1	4.6	–	4.6
Environmental protection	58.7	50.3	8.4	51.2	51.2	–
Restructuring	1.4	0.1	1.3	0.8	0.8	–
Other	13.6	8.1	5.5	23.0	17.7	5.3
Other provisions	194.8	170.2	24.6	181.3	166.8	14.5
Tax provisions	148.6	90.8	57.8	101.1	78.2	22.9

Tax Provisions

Tax provisions contain amounts for current income tax obligations, risks from tax audits, and legal action. The existing long-term tax provisions will largely be used over the next three to five years.

Provisions for Personnel

These provisions contain obligations for anniversary payments, other deferrals, and provisions relating to early retirement and semi-retirement plans. There is a continuous outflow of noncurrent provisions for anniversary payments. The provision for semi-retirement plans will be exhausted by 2015 at the latest. The outflow will be continuous until that date.

Sales/Purchasing Provisions

These provisions cover obligations from warranty and product liability as well as discounts, cash bonuses, or other price reductions, commissions for sales agents, and impending losses from contractual agreements.

Provisions for Environmental Protection

Provisions for environmental protection are formed for anticipated obligations regarding site contamination, water pollution control, recultivation of landfills, the clean-up of contaminated storage and production sites, and similar environmental measures. These provisions also include environmental protection charges likely to be imposed by the government. Most noncurrent provisions for environmental protection will be utilized over a period of ten to twenty years.

Restructuring Provisions

The provisions for restructuring are comprised of severance payments for departing employees, anticipated site closure expenses, demolition obligations, and similar charges.

Other Provisions

These provisions are formed for a multiplicity of identifiable individual risks and contingencies (e.g. damages, legal risks).

Sundry Provisions

€ million	Jan. 1, 2008	Utilization	Reversal	Addition/ interest effect	Exchange rate differences	Scope of con- solidation/ other	Dec. 31, 2008
Personnel	101.7	- 3.3	- 0.1	15.1	0.1	0.5	114.0
Sales/purchasing	4.6	- 5.5	- 0.4	8.0	0.2	0.2	7.1
Environmental protection	51.2	- 3.2	- 3.6	13.8	0.7	- 0.2	58.7
Restructuring	0.8	- 0.7	-	1.1	0.2	-	1.4
Other	23.0	- 4.6	- 8.5	3.4	0.3	-	13.6
	181.3	- 17.3	- 12.6	41.4	1.5	0.5	194.8
Of which interest effect	-	-	-	1.9	-	-	-

The interest effect is mainly accounted for by provisions for environmental protection.

Tax Provisions

€ million	Jan. 1, 2008	Utilization	Reversal	Addition/ interest effect	Exchange rate differences	Scope of con- solidation/ other	Dec. 31, 2008
Taxes	101.1	- 24.5	- 0.2	59.9	7.0	5.3	148.6
Of which interest effect	-	-	-	0.1	-	-	-

15 Financial Indebtedness

€ million	2008			2007		
	Total	Of which noncurrent	Of which current	Total	Of which noncurrent	Of which current
Liabilities to banks	180.1	114.2	65.9	131.3	102.7	28.6
of which > 5 years	-	-	-	-	-	-
Liabilities from lease obligations ¹	56.3	44.5	11.8	67.4	56.2	11.2
of which > 5 years	-	12.4	-	-	16.7	-
Loans from employees ²	5.6	-	5.6	10.6	5.2	5.4
of which > 5 years	-	-	-	-	-	-
Liabilities to associated companies	27.8	-	27.8	6.0	-	6.0
of which > 5 years	-	-	-	-	-	-
Other financial liabilities	2.6	-	2.6	2.5	0.1	2.4
of which > 5 years	-	-	-	-	-	-
	272.4	158.7	113.7	217.8	164.2	53.6
of which > 5 years	-	12.4	-	-	16.7	-

¹ Liabilities from lease obligations primarily include liabilities from leasing the headquarters building in Munich and the Burghausen plant's CCGT power station.

² These are loans made by employees to Wacker Chemie AG to promote employee capital formation.

No collateral exists for financial liabilities. If the Group is unable to fulfill its repayment obligations with regard to loans from employees, there are bank guarantees in place for securing employees' benefits. Some of the liabilities to banks are fixed-interest and others have variable interest rates. Loans from employees have fixed percentage rates. Some of the liabilities to banks were granted on the condition that certain covenants are complied with.

The liabilities to associated companies result primarily from the financial investment of the joint venture WACKER SCHOTT Solar GmbH within the framework of cash pooling.

16 Liabilities

€ million	2008			2007		
	Total	Of which noncurrent	Of which current	Total	Of which noncurrent	Of which current
Tax liabilities	14.1	–	14.1	13.4	–	13.4
of which > 5 years	–	–	–	–	–	–
Trade payables	296.7	–	296.7	241.8	–	241.8
of which > 5 years	–	–	–	–	–	–
Payables to associated companies	–	–	–	3.3	–	3.3
Advance payments from associated companies	76.5	74.4	2.1	–	–	–
Payables relating to social security	2.7	–	2.7	1.5	–	1.5
Payroll liabilities	2.7	–	2.7	2.5	–	2.5
Profit-sharing and other bonuses	119.0	–	119.0	124.0	–	124.0
Other personnel liabilities	35.9	–	35.9	28.6	–	28.6
Derivative financial instruments	54.2	12.0	42.2	9.4	3.0	6.4
Deferred income	7.3	5.6	1.7	0.2	0.1	0.1
Advance payments received (third parties)	859.6	761.8	97.8	665.7	604.7	61.0
Sundry liabilities	30.2	1.8	28.4	19.7	1.7	18.0
Other liabilities	1,188.1	855.6	332.5	854.9	609.5	245.4
of which > 5 years	–	334.5	–	–	312.8	–

In addition to those amounts for which Group companies are liable to pay tax, tax liabilities also include taxes paid for the account of third parties. Payables relating to social security refer in particular to social security contributions that have yet to be paid. The other payroll liabilities include, in particular, vacation and flextime credits as well other HR-related liabilities.

The advance payments received are primarily connected with future polysilicon deliveries resulting from the capacity expansions at the polysilicon plant in Germany.

17 Contingencies/Other Obligations

Contingencies are potential obligations based on past events of which the existence will not be confirmed until the occurrence of one or more uncertain future events which are beyond the Group's influence. Present obligations, moreover, can likewise be contingencies if the likelihood of an outflow of resources is not strong enough to justify the recognition of a provision and/or the amount of the obligations cannot be estimated with sufficient reliability. The values assigned to contingencies correspond to the degree of liability that exists on the balance sheet date.

The contingencies and other obligations shown below are nominal values.

€ million	2008	2007
Guarantees/obligations to make additional contributions	73.7	34.2

As of December 31, 2008, there were contingencies of €34.0 million relating to an obligation to make an additional contribution in connection with setting up our joint venture Siltronic Samsung Wafer Pte. Ltd. in Singapore.

Wacker Chemie AG has committed itself to support in the external financing of a joint venture by eventually issuing suretyships or other collateral amounting to €120 million.

There is a finance lease for the headquarters building in Munich which is used by the Group. The contract with the lessor expires in 2012. After that, WACKER's pension fund or some company specified by it shall have the right to purchase the building at a price that has already been fixed.

Wacker Chemie AG has also capitalized a finance lease for the leased CCGT power station at its Burghausen site. The lease for the power station is due to expire in 2016 at the latest, although it can be terminated prematurely. In either case, WACKER has the right to acquire the power station at a price oriented to book values in accordance with German commercial law. If WACKER acquires this power station, it may not be sold to a third party for five years.

€ million	2008		2007	
	Nominal value	Present value	Nominal value	Present value
Minimum lease payment within a year	14.7	11.8	14.7	11.2
Minimum lease payment within one and five years	37.6	32.1	47.1	39.5
Minimum lease payment of more than five years	13.3	12.4	18.4	16.7
	65.6	56.3	80.2	67.4
Total expected minimum payments from subtenancies	3.0	–	3.3	–

There are no conditional lease payments from finance leases.

Operating leases are used in particular for motor vehicles and IT equipment. These leases generally have terms of between three and five years. Tenancy agreements for office space, etc. have considerably longer terms.

€ million	2008	2007
Obligations from rent and operating leases		
due within one year	11.1	8.6
due between one and five years	11.9	12.7
due after five years or more	6.0	5.4
	29.0	26.7
Lease payments occasioned by operating leases	10.4	8.5
Obligations from orders for planned investment projects (commitments)	353.2	269.9
Obligations related to subsequent purchase price payment for business activity	–	1.2

Wacker Chemie AG has signed an agreement with joint-venture partners (Dow Corning, Samsung) to make investments in future years and provide necessary equity funds and/or loans. As of the balance sheet date, the Group expects further contractual contributions to equity amounting to some US\$54 million. In addition, the Group is making a

guarantee for borrowed funds amounting to some US\$250 million. Of this total, guarantees for US\$75.5 million have already been given. This is already included in the disclosure of guarantees/obligations to make additional contributions above.

The Group receives government subsidies for investment activities. These subsidies are tied to the condition that a certain number of jobs are created or maintained at certain times. If these contractual commitments are not fulfilled, any funding received must be paid back either in full or in part. The period for which the Group has to fulfill its contractual commitments is limited.

In order to safeguard the supply of the raw material ethylene at the Burghausen plant, Wacker Chemie AG has acquired a stake in EPS Ethylen-Pipeline-Süd GmbH & Co. KG, Munich. The capital contribution obligations that this acquisition involves amount to some €1 million and are likely to fall due in 2009.

18 Other

€ million	2008	2007
Cost of materials	-1,787.2	-1,320.5
Personnel expenses		
Wages and salaries	- 865.3	- 824.6
Social security and other benefits	- 141.1	- 137.3
State pension contributions	52.1	51.3
Social insurance contributions	- 89.0	- 86.0
Pension expenses	- 79.7	- 53.0
State pension contributions	- 52.1	- 51.3
Expenses for post-employment benefits	- 131.8	- 104.3
	-1,086.1	-1,014.9

Social insurance contributions refer mainly to the employer's share of social security contributions and to employers' liability insurance association contributions. The pension expenses consist mainly of pension payments and allocations to pension provisions. Related interest is shown in the financial result. The expenses incurred in transfers to external pension funds and pension plans are likewise included in pension expenses.

In the reporting year, special allocations affecting results were made to Wacker Chemie Pensionskasse VVaG in the amount of €40.0 million.

Expenses for Auditor's Fee

€ million	2008	2007
Audit	0.9	1.0
Other certification services	0.4	0.3
Tax advice	–	0.2
	1.3	1.5

The other certification services are largely comprised of the cost of interim reviews.

19 Earnings Per Share/Dividend

		2008	2007
Average number of outstanding common shares	Units	49,677,983	49,677,983
Number of common shares outstanding at year-end	Units	49,677,983	49,677,983
Dividend per dividend-bearing common share	€	1.80	2.25
Special bonus related to best-ever fiscal year	€	–	0.75
Dividend paid per dividend-bearing common share	€	1.80	3.00
Net income for the year after minority interests	€ million	439.4	422.0
Earnings due to common shares	€ million	439.4	422.0
Earnings per common share (average)	€	8.84	8.49
Earnings per common share (on balance sheet date)	€	8.84	8.49

The diluted earnings per share are identical to the basic earnings in both the year under review and the previous year.

An earnings per share item relating to results from continued or discontinued business activity as well as an effect from changes in the accounting and valuation methods is not reported due to a lack of relevant factual information.

The dividend payout for the 2007 fiscal year amounted to €149.1 million, or €3.00 per dividend-bearing share.

The Executive Board of Wacker Chemie AG proposed the aforementioned dividend for the fiscal year 2008. The proposed dividend relates solely to dividend-bearing shares, i.e. excluding treasury shares. The acceptance or rejection of this proposal is incumbent on the shareholders' meeting of Wacker Chemie AG. Subject to the shareholders' approval, a sum of €89,420,369.40 will be paid out for the total of 49,677,983 no-par-value shares not owned by the company.

20 Financial Instruments

Primary Financial Instruments

Carrying Amounts of Financial Assets and Liabilities (Classified by Category as per IAS 39)

€ million	2008	2007
Financial assets		
Held-to-maturity securities	49.5	238.6
Loans and receivables	529.0	463.5
Available-for-sale financial assets		
Cash and cash equivalents excluding held-to-maturity securities	255.8	127.9
Other available-for-sale financial assets	267.5	247.3
Derivative financial instruments	52.2	57.7
	1,154.0	1,135.0
Financial liabilities		
Financial liabilities recognized at amortized cost	272.4	250.4
Trade payables	296.7	241.8
Other liabilities ¹	1,140.7	858.7
Derivative financial instruments	54.2	9.4
	1,764.0	1,360.3

¹ Include sundry liabilities and tax liabilities shown in the balance sheet, with the exception of derivative financial instruments and deferred income.

Carrying Amounts and Market Values of Financial Assets and Liabilities Measured at Cost or Amortized Cost*

€ million		2008		2007
	Carrying amount	Market value	Carrying amount	Market value
Financial assets				
Investments ¹	9.8	–	68.6	–
Noncurrent loans	62.2	62.2	2.1	2.1
Trade receivables	466.8	466.8	461.4	461.4
Tax receivables	102.6	102.6	76.3	76.3
Other receivables ²	124.4	124.4	102.4	102.0
Cash and cash equivalents	204.2	204.6	366.5	366.5
	970.0	960.6	1,077.3	1,008.3
Financial liabilities				
Financial indebtedness	272.4	272.4	250.4	250.4
Trade payables	296.7	296.7	241.8	241.8
Other liabilities	1,140.7	1,140.7	858.7	858.7
	1,709.8	1,709.8	1,350.9	1,350.9

* (accounted for at acquisition cost or net book value)

¹ This item contains available-for-sale financial assets of which the market values cannot be calculated reliably and which have been recognized at cost. This item, along with noncurrent loans, is shown in the balance sheet under noncurrent financial assets.

² Other receivables are shown under noncurrent and current other assets.

The interest expenses contain €10.4 million (2007: €13.7 million) from financial liabilities recognized at amortized cost. No profit was generated by the redemption of those financial instruments. Loans and receivables or financial liabilities at amortized cost in a foreign currency produced net profit of €126.0 million (2007: €24.5 million) and net loss of €–127.1 million (2007: €–43.9 million). These are presented under other operating income and expenses. Net profits from available-for-sale financial assets originate mainly from investment income. In addition, other operating income and expenses include €9.5 million (2007: €–3.4 million) from the currency translation of cash and cash equivalents. Derivative financial instruments of which the market values changes are recognized in profit or loss led to net earnings of €15.8 million (2007: €32.7 million). €32.9 million (2007: €23.2 million) of this sum relates to derivatives from hedge accounting which are listed under other operating income and expenses. Financial assets and liabilities did not undergo any major impairments. Neither in the year under review nor in the previous year were there any reclassifications of financial assets between those recognized at amortized cost and those recognized at market value or vice versa.

Derivative Financial Instruments

WACKER is exposed to exchange rate, interest rate, and raw materials price risks in the normal course of its business. The raw material price risks that it hedges against result principally from precious metals (platinum, gold, palladium) which are used as catalysts or for other purposes in the production process.

In those cases where WACKER hedges against these risks, it uses derivative financial instruments, in particular currency option and forward exchange contracts, and foreign exchange swaps. Derivatives are used only if they are backed by positions, cash deposits and funding, or scheduled transactions arising from operations (underlying transaction). The scheduled transactions also include anticipated, but not yet invoiced sales in foreign currencies.

Foreign exchange hedging is carried out mainly for the US dollar (US\$), the Japanese yen, and the Singapore dollar. In the case of foreign exchange hedging in the financing area, the maturities of the receivables and/or liabilities are taken into account. Interest rate hedging is carried out primarily for the euro and the US dollar, with the maturities of the underlying transactions being the most important factor.

Operational hedging in the foreign exchange area relates to the receivables and liabilities already recognized and generally encompasses time horizons of between three and four months. The time horizon of strategic hedging is between four and a maximum of 27 months. The hedged cash flows influence the income statement at the time when sales are realized. The cash inflows are usually recorded shortly afterwards, depending on the payment deadline. As well as receivables from and liabilities to third parties, intercompany financial receivables and liabilities are hedged.

WACKER is exposed to a credit risk where derivatives have a positive market value and counterparties to a contract are unable to render their performance. To limit the risk of default, transactions are conducted only within defined limits and with partners of extremely high credit standing. To make efficient risk management possible, the market risks within the Group are controlled centrally. The conclusion and handling of transactions comply with internal guidelines and undergo monitoring procedures that take account of the division of functions.

The market values refer to the maturity repurchase values (redemption values) of the financial derivatives as of the balance sheet date. They are calculated on the basis of quoted prices or with the help of standard calculation methods.

In the valuation of forward contracts WACKER applies consistently with the previous year the zero-coupon method. With the global economic crisis impacting financial markets other valuation models (e.g. the par method) could result in different fair values and thus increasing or decreasing net income at the time of liquidation. WACKER though does not intend to realize a derivative before maturity according to the hedging relationship. In principle, all valuation models are subject to greater risk stemming from the current financial crisis. Therefore one cannot rely on the existence of a market where such fair values derived from valuation models have any relevance.

The derivatives are measured at their market values, irrespective of their stated purpose. They are reported in the balance sheet under other assets and/or other liabilities. Where permissible, we apply hedge accounting for the strategic hedging of currency exchange risks

from future foreign exchange positions. In such cases, the changes in the market value of foreign exchange contracts and the changes in the intrinsic value of currency options are recognized under equity with no effect on net income until the underlying transaction takes place. The changes in the time values of the currency options are posted to the income statement. In some cases there are embedded derivatives. Those are measured at fair value if derivable. Otherwise they are measured at amortized cost. Embedded derivatives are also reported under other assets or other liabilities, respectively.

Depending on the nature of the underlying transaction, they are presented in the income statement either under other operating income and/or expenses or, if financial liabilities are being hedged, under the interest result.

€ million	Dec. 31, 2008		Dec. 31, 2007	
	Nominal values	Market values	Nominal values	Market values
Foreign exchange derivatives	1,777.3	-2.5	1,450.9	67.0
Interest rate derivatives	-	-	50.0	-
Other derivatives	1.9	0.5	5.9	0.1
Of which market values related to derivative financial instruments within the framework of hedge accounting	-	-17.6	-	41.1

The increase in the nominal values of foreign exchange derivatives results mainly from two facts: a higher hedging ratio and an extension in the hedging horizon. The currency option transactions that were still unsettled at the end of 2008 will fall due in the course of the subsequent fiscal years (2009 – 2010).

The currency option volumes as of year-end 2008 were US\$30 million (puts) and ¥3.9 billion (puts). In addition, there are forward exchange contracts amounting to US\$1.43 billion and ¥32.8 billion.

A cross-currency swap was used as a foreign exchange hedge for an existing loan of US\$70 million. It matures in 2010.

Information on the Type and Extent of Risks

The risks connected with the procurement, financing, and selling of WACKER's products and services are described in detail in the management report. The Executive Board regularly receives analyses on the extent of those risks. The analyses focus in particular on the potential impact of raw material price risks, foreign exchange risks, and interest rate risks on EBITDA and net interest income.

Foreign Exchange Risks

The evaluation of the risk potential of hedging is based on the most significant US-dollar income and expenditure. US-dollar income is defined as all sales invoiced in US dollars,

while the expenditure in question is defined as all US-dollar purchases and all site-related costs incurred in US dollars. In addition to the direct US-dollar income and expenditure, the evaluation of potential risks includes the indirect US-dollar impact of the main raw materials (methanol and natural gas). An increase of 1 US-cent in the exchange rate of the euro against the US-dollar would cause EBITDA to fall by €5.3 million (2007: €6.6 million). In this number hedges of the US\$ exposure are not implied. Increases in the euro exchange rate against the SGD and JPY, on the other hand, have only a minor impact.

Interest Rate Risk

The interest rate risk results mainly from financial debt and interest-bearing assets. Each year, the Executive Board determines the mixture of fixed and variable-interest net financial debt. The interest rate risks are measured on the basis of market-value or cashflow sensitivity, depending on whether the instrument in question (financial liabilities, investments, interest rate derivatives) has a fixed or variable interest rate. Financial liabilities and fixed-interest investments are measured at net book value and are, therefore, in accordance with IFRS 7, not subject to any risk of changes in interest rates. Hedge accounting is not used for any of the interest rate derivatives. Changes in market interest rates have an impact on the net interest income generated by variable-interest financial instruments and are, therefore, included in the calculation of earnings-related sensitivity. Changes in the market interest rates of interest rate derivatives affect the financial result and are, therefore, included in any earnings-related sensitivity analysis. If current interest rates had been 100 base points higher (lower) on average, net interest income would have been €2.1 million (2007: €0.8 million) higher (lower).

Liquidity Risk

The liquidity risk means that WACKER may not be able to meet its financial obligations sufficiently. To limit this risk, WACKER keeps liquid reserves in the form of current investments and credit lines. WACKER has concluded agreements with a number of banks for long-term syndicated loans and bilateral loan agreements. The aggregate volume of these loans is significantly higher than the planned financial liabilities.

Raw Materials Price Risk

Potential combinations of factors in the natural gas or ethylene segments make it impossible to exclude the risk that the company's supply of raw materials might be insufficient. Ethylene-related risks, however, will be reduced substantially by the EPS pipeline which is currently under construction in Germany. In general, potential increases in raw materials prices pose a risk to results. An increase of 1% would lead to a drop of €9.1 million (2007: €6.8 million) in EBITDA.

21 Notes on the Cash Flow Statement

The cash flow from operating activity is calculated using the indirect method. The indirect calculation adjusts the relevant changes in balance sheet items to remove any exchange rate effects and/or changes in the scope of consolidation. This means that the changes to the relevant balance sheet items cannot be reconciled with the corresponding values based on the published consolidated balance sheets.

The changes in the payments made and received in advance encompass transactions with both third parties and associated companies. The cash flow from investment activity shows the actual outflow of funds; so these figures also cannot be reconciled with the additions in fixed assets in the consolidated balance sheet. If subsidiaries or business activities are acquired or sold, the influences ensuing from these transactions are shown as separate items in the cash flow statement. Financial investment in current securities falling due in more than three months is reported separately under cash flow from investing activity, as these transactions must rather be attributed to the cash and cash equivalents in economic terms. The Group is financed mainly by bank loans granted in the form of loan commitments. Within the defined approval limits for loan commitments, our utilization of credit may be subject to considerable fluctuations both within a year and over several years.

The raising and repayment of loans in foreign currencies are translated at the exchange rate prevailing at the time of the transaction, with the result that here too, a reconciliation of the entire inflows and outflows for changing the financial liabilities in the balance sheet is not possible.

For more details on the composition of cash and cash equivalents. → [See Note 11](#)

Items Contained in the Cash Flow from Operating Activities are:

€ million	2008	2007
Tax payments	- 178.7	- 166.7
Interest payments	- 11.7	- 16.9
Interest income	17.3	14.6
Dividends received	1.1	8.8

Non-cash Transactions

€ million	2008	2007
Siltronic	24.5	-
Silicones	3.1	-
Polymers	- 13.0	-
Polysilicon	0.5	-
Fine Chemicals	1.5	-
Other	- 7.8	15.3
	8.8	15.3

22 Explanatory Notes on Segment Reporting

The section on segment reporting defines the WACKER Group's activities primarily by business segment and secondarily by region. This distinction takes account of internal control functions and reporting as well as the different risk and income structures within the segments. The management report provides a detailed description of WACKER's primary segments. WACKER's secondary segments are defined in the section on segments by region. The secondary segment to which a company is assigned is determined by that company's country of incorporation.

Any activities not assigned to a primary segment are shown under "Other." Currency translation results which cannot be assigned to a segment are likewise shown in this item.

Balance sheet and income statement items are assigned to the primary segments in accordance with commercial discretion. Assets used jointly by several segments are generally shown under "Other" if they cannot be assigned clearly to a particular segment. A similar approach is adopted for borrowed funds.

Segment information is essentially based on the same presentation and accounting policies as the consolidated financial statements. Receivables and liabilities, provisions, income, expenses, and results between the segments are eliminated in the course of consolidation.

The Segment Information Was Obtained as Follows:

- The internal sales show the sales that are generated between the segments. They are settled mainly on the basis of market prices or planned direct costs.
- EBIT corresponds to operating income plus or minus income from investments in joint ventures and associates as well as other income from participations.
- The composition of other income from participations is shown in the section on financial results.
- Asset additions refer to intangible assets; property, plant, and equipment; investment property; and financial assets.
- Depreciation and write-ups refer to intangible assets; property, plant, and equipment; investment property; and financial assets.
- Assets encompass all of the assets depicted as such in the balance sheet. Lendings, cash and cash equivalents, and deferred tax assets, however, are basically allocated to the division "Other".
- All borrowed funds are shown as liabilities. The Group's financial liabilities are allocated in proportion to the segment assets.
- In the presentation of segments by region, we have listed assets, liabilities, and asset additions in accordance with the respective Group company's country of incorporation.
- Net assets correspond to equity.
- The Siltronic segment prepares its own partial consolidated financial statements. The figures in those financial statements are included largely unaltered in the Group's segment information. For this reason, the apportionment rules (e.g. financial liabilities) applicable between the other divisions do not apply to Siltronic.

Impairments included with no effect on income essentially relate to the changes in the market values of derivative financial instruments from cash flow hedging. Of these, €-37.9 million (2007: €25.5 million) are accounted for by the Siltronic segment and €12.1 million (2007: €20.1 million) by the division "Other".

23 Significant Group Companies

I. Affiliated Companies

%	Share in capital
Germany	
DRAWIN Vertriebs-GmbH, Ottobrunn	100
Siltronic AG, Munich	100
Wacker Polymer Systems GmbH & Co. KG, Burghausen	100
Wacker-Chemie Dritte Venture GmbH, Munich	100
Wacker Biotech GmbH, Jena	100
Europe (excluding Germany)	
Wacker Chimie S.A.S., Lyon (France)	100
Wacker-Chemicals Ltd., Egham, Surrey (UK)	100
Wacker-Chemie Italia S.r.L., Peschiera Borromeo/Milan (Italy)	100
Siltronic Holding International B.V., Krommenie/Amsterdam (NL)	100
Wacker-Chemie Benelux B.V., Krommenie/Amsterdam (NL)	100
Wacker-Chemie S.r.o., Prague (Czech Republic)	100
Americas	
Wacker Chemical Corp., Adrian, Michigan (USA)	100
Siltronic Corp., Portland, Oregon (USA)	100
Wacker Polymer Systems L.P., Adrian, Michigan (USA)	100
Wacker Quimica do Brasil Ltda., São Paulo (Brazil)	100
Asia	
Siltronic Singapore Pte. Ltd., Singapore	100
Siltronic Japan Corp., Hikari (Japan)	100
Wacker Chemicals Hongkong Ltd., Hongkong (China)	100
Wacker Chemicals China Ltd., Hongkong (China)	100
Wacker Metroark Chemicals Pvt. Ltd., Parganas (India)	51
Wacker Polymer Systems (ZJG) Co. Ltd., Zhangjiagang (China)	100
Wacker Polymer Systems (WUXI) Co. Ltd., Wuxi (China)	100
Wacker Chemicals (Zhangjiagang) Co. Ltd., Zhangjiagang (China)	100
Wacker Chemicals (China) Company Ltd. (Holding), Shanghai (China)	100

II. Companies Accounted for Using the Equity Method

%	Share in capital
Wacker Asahi Kasei Silicone Co. Ltd., Tokyo (Japan)	50
Dow Corning (ZJG) Holding Co. Private Ltd., Singapore (Singapore)	25
Wacker Dymatic (Shunde) Co. Ltd., Guangdong (China)	50
Planar Solutions L.L.C., Adrian, Michigan (USA)	50
Siltronic Samsung Wafer Pte. Ltd., Singapore (Singapore)	50
WACKER SCHOTT Solar GmbH, Jena (Germany)	50

The ownership of shares is listed separately in accordance with Section 313 (4) of the German Commercial Code (HGB).

Key Figures for Joint Ventures

€ million	2008		2007	
	Total	Wacker holding	Total	Wacker holding
Sales	270.2	135.2	86.5	43.3
Operating income	-29.5	-14.7	-9.6	-4.9
Result after taxes	-40.7	-20.4	-9.3	-4.6
Noncurrent assets	664.9	332.5	429.9	215.0
Current assets	271.6	135.9	120.8	60.4
	936.5	468.4	550.7	275.4
Equity	325.9	163.1	355.8	177.8
Noncurrent liabilities	494.6	247.3	115.9	58.0
Current liabilities	116.0	58.0	79.0	39.6
	936.5	468.4	550.7	275.4

Key Figures for Associated Companies

€ million	2008		2007	
	Total	Wacker holding	Total	Wacker holding
Sales	8.5	3.0	26.7	9.3
Operating income	- 29.7	- 7.5	- 21.2	- 5.1
Result after taxes	- 39.9	- 10.1	- 25.1	- 6.3
Noncurrent assets	480.9	120.2	254.2	65.4
Current assets	15.0	3.7	31.3	9.6
	495.9	123.9	285.5	75.0
Equity	127.8	31.9	62.6	17.3
Noncurrent liabilities	65.6	16.4	111.3	27.8
Current liabilities	302.5	75.6	111.6	29.9
	495.9	123.9	285.5	75.0

24 Related Party Disclosures

IAS 24 stipulates that parties which control, or are controlled by, Wacker Chemie AG must be specified unless they are already included in Wacker Chemie AG's consolidated financial statements as a consolidated company. Control in this sense is held to apply when a shareholder has more than half of the voting rights in Wacker Chemie AG or, by virtue of provisions in the Articles of Incorporation or contractual arrangements, has the possibility of controlling the financial and business policy of the WACKER Group's Executive Board.

In the year under review, the WACKER Group is affected by the disclosure obligations under IAS 24 only in respect of the business relations with Wacker Chemie AG's major shareholders and its Executive and Supervisory Board members.

The relationship of internal performance allocation between Wacker Chemie AG and its majority shareholder Dr. Alexander Wacker Familiengesellschaft mbH is of subordinate importance. Furthermore, WACKER Group companies did not conduct any significant transactions with members of Wacker Chemie AG's Executive or Supervisory Board or with any other key management personnel or with companies of which these persons are members of executive or supervisory bodies. This likewise applies to close relatives of the aforementioned persons.

Dr. Alexander Wacker Familiengesellschaft mbH, Munich, informed Wacker Chemie AG on June 7, 2006, that it holds over 50% of the voting shares in Wacker Chemie AG. Blue Elephant Holding GmbH, Pöcking, informed Wacker Chemie AG on April 12, 2006, that it holds over 10% of the voting shares in Wacker Chemie AG. Artisan Partners Limited Partnership, Wisconsin (USA) informed Wacker Chemie AG on September 28, 2007, that it holds over 5% of the voting shares in Wacker Chemie AG.

In addition, trade is conducted between some Group companies and their associated companies in the normal course of business. Business transactions are conducted under usual market terms and conditions. Receivables from and liabilities to associated companies are indicated in Notes 10 and 16. In the year under review, associated companies were charged €119.0 million (2007: €72.1 million) for sales, license revenue, and administrative expense allocations. Conversely, associated companies submitted invoices for material purchases and commissions in the amount of €11.8 million (2007: €1.1 million) in the year under review.

In the year under review, Wacker Chemie AG acquired real estate with a value of €8.3 million from Pensionskasse der Wacker Chemie VVaG under usual market terms.

Compensation for the Supervisory and Executive Boards

€	Fixed compensation	Variable compensation	Pensions/ service cost	Total
Executive Board compensation 2008	2,721,739	4,476,306	855,206	8,053,251
Executive Board compensation 2007	2,562,100	4,562,500	1,079,563	8,204,163
Pension commitments for active members of the Executive Board 2008				11,882,999
Pension commitments for active members of the Executive Board 2007				12,357,586
Expenses for former members of the Executive Board and their surviving dependents 2008				2,787,599¹
Expenses for former members of the Executive Board and their surviving dependents 2007				817,164
Pension commitments for former members of the Executive Board and their surviving dependents 2008				16,446,268
Pension commitments for former members of the Executive Board and their surviving dependents 2007				8,639,697
Supervisory Board compensation 2008	511,000	393,750		904,750
Supervisory Board compensation 2007	507,000	393,750		900,750

¹This includes payments to former Executive Board members upon termination of employment contracts in the amount of €1,982,171 (2007: €0).

Detailed information about Executive Board compensation is contained in the compensation report. The compensation report is part of the management report. German commercial law (HGB) requires the inclusion of this information in the notes to the consolidated financial statements. → [More Information on page 202](#)

The members of Wacker Chemie AG's Supervisory Board and Executive Board are listed on the following pages.

Munich, Germany, February 20, 2009
Wacker Chemie AG

Rudolf Staudigl Wilhelm Sittenthaler

Joachim Rauhut Auguste Willems

Supervisory Board

As of December 31, 2008

192 Consolidated Financial Statements ...// Supervisory Board

Dr. Peter-Alexander Wacker^{1, 2, 3}

(from May 8, 2008)

Chairman
Starnberg
Business studies graduate (Diplom-Kaufmann)

Managing Director

Dr. Alexander Wacker Familiengesellschaft mbH
Member of the Supervisory Board/Advisory Council
Giesecke & Devrient GmbH
INA-Holding Schaeffler KG
Member of the Governing Board
Bankhaus Reuschel & Co.

Anton Eisenacker^{* 1, 2, 3}

Deputy Chairman
Perach
Certified Chemicals Technologist

Peter Áldozó*

Burghausen
HR specialist

Dr. Konrad Bachhuber*

(from May 8, 2008)

Zhangjiagang (China)
Plant Manager, Zhangjiagang (China)

Matthias Biebl

(from May 8, 2008)

Munich
Attorney

Legal Adviser

Bayerische Hypo- und Vereinsbank AG

Dr. Werner Biebl

Munich
Chief Public Prosecutor (retired)

Managing Director

Dr. Alexander Wacker Familiengesellschaft mbH

Marko Fartelj*

Kirchdorf
Machine Operator

Uwe Fritz^{* 1}

Julbach
District Chairman of the industrial trade union
IG Bergbau, Chemie, Energie – Altötting

Member of the Supervisory Board
Siltronic AG**

Eduard-Harald Klein*

Neuötting
Operator

Manfred Köppl*

Kirchdorf
Industrial Mechanic

Franz-Josef Kortüm^{1, 2}

Munich

Chairman of the Executive Board
WEBASTO AG
Member of the Advisory Council
Brose Fahrzeugteile GmbH & Co. KG

Seppel Kraus*

Olching
Land head of labor union IG BCE, Bavaria

Member of the Supervisory Board
Novartis Deutschland GmbH
Hexal AG

Dr. Thomas Strüngmann

Tegernsee
Business studies graduate (Diplom-Kaufmann)

Co-Managing Director
Athos Service GmbH
Member of the Supervisory Board
MediGene AG
4SC AG

Dr. Bernd W. Voss³

Kronberg i. T.

Member of the Board of Directors
ABB Ltd.
Deputy Chairman of the Governing Board
Bankhaus Reuschel & Co.
Member of the Supervisory Board
Dresdner Bank AG
Continental AG
Hapag Lloyd AG

Dr. Susanne Weiss

(from May 8, 2008)

Munich
Attorney

Chair of the Supervisory Board
ROFA AG

Prof. Dr. Ernst-Ludwig Winnacker

Munich
Professor of Biochemistry at LMU, Munich
Secretary General of the European Research Council

Chairman of the Supervisory Board
MediGene AG
Member of the Supervisory Board
Bayer AG

Supervisory Board members who departed in the 2008 fiscal year:**Gertrud Eberth-Heldrich**

(until May 8, 2008)

Munich
Attorney

Prof. Dr. Stefan Leberfinger

(until May 8, 2008)

Munich
Auditor, tax consultant

Chairman of the Executive Board
Hubert-Burda-Stiftung
Member of the Executive Board
Nathalie-Todenhöfer-Stiftung
Member of the Supervisory Board/Advisory Council
DOMAG Wohnbau AG
Tomorrow Focus AG
Thurn & Taxis Gesamtverwaltung
Freiberger Holding GmbH & Co. KG

Hans-Joachim Stadter*

(until May 8, 2008)

Burghausen
Head of personnel development

Dr. Karl Heinz Weiss^{1, 2, 3}

(until May 8, 2008 Chairman)

Munich
Attorney

Managing Director
Dr. Alexander Wacker Familiengesellschaft mbH
Member of the Supervisory Board/Advisory Council
Giesecke & Devrient GmbH
Carl Hanser GmbH & Co. KG

¹ Mediation Committee Chairman: Dr. Peter-Alexander Wacker

² Executive Committee Chairman: Dr. Peter-Alexander Wacker

³ Audit Committee Chairman: Dr. Bernd W. Voss

* Employees' representative

** Subsidiaries

Dr. Voss has informed us that he will depart from the Supervisory Board of Hapag Lloyd AG in 2009.

Dr. Susanne Weiss has informed us that she was elected as a member of the Supervisory Board of Bayerische Hypo- und Vereinsbank AG on February 5, 2009.

Executive Board

As of December 31, 2008

194 Consolidated Financial Statements ...// Executive Board

Dr. Rudolf Staudigl

President & CEO

WACKER SILICONES

Executive Personnel, Corporate Development,
Corporate Communications, Investor Relations,
Corporate Auditing, Legal & Insurance,
Corporate R&D, Intellectual Property

Chairman of the Supervisory Board

Siltronic AG**

Pensionskasse der Wacker Chemie VVaG

Member of the Supervisory Board /

Advisory Council

Groz-Beckert KG

Deutsche Bank AG

Chairman of the Bayerische Chemieverbände

Dr. Joachim Rauhut

WACKER POLYSILICON

Corporate Accounting, Corporate Controlling,
Corporate Finance, Information Technology, Raw
Materials Procurement, Technical Procurement &
Logistics, Tax

Regions: Europe, NAFTA

Member of the Supervisory Board/Advisory Council

J. Heinrich Kramer Holding GmbH

Siltronic AG**

Pensionskasse der Wacker Chemie VVaG

Dr. Wilhelm Sittenthaler

(from May 8, 2008)

SILTRONIC

Human Resources (Personnel Director)

Region: Asia/Pacific

Member of the Supervisory Board

Pensionskasse der Wacker Chemie VVaG

Chairman of the Board of Directors

Siltronic Samsung Wafer Pte. Ltd.***

Auguste Willems

WACKER POLYMERS, WACKER FINE CHEMICALS

Corporate Engineering, Sales & Distribution,
Site Management, Corporate Security

Regions: Middle East, India, South America

Dr. Peter-Alexander Wacker

(until May 8, 2008)

Member of the Supervisory Board/Advisory Council

Giesecke & Devrient GmbH

INA-Holding Schaeffler KG

Member of the Governing Board

Bankhaus Reuschel & Co.

** Subsidiaries

*** Joint Ventures

With effect from January 1, 2009, Dr. Rudolf Staudigl will step down as member and Chairman of the Supervisory Board at Siltronic AG. Dr. Wilhelm Sittenthaler will take over as Chairman of the Supervisory Board at Siltronic AG on the same date.

Effective from May 8, 2008, the former Chairman of the Executive Board Dr. Peter-Alexander Wacker resigned from Wacker Chemie AG's Executive Board and took over the Chairmanship of the Supervisory Board of Wacker Chemie AG. At that time, the member of the Executive Board, Dr. Rudolf Staudigl was appointed as Chairman.

Until mid of 2008, Dr. Peter-Alexander Wacker held the Chairmanships of the Supervisory Boards of both Siltronic AG and Pensionskasse der Wacker Chemie VVaG.

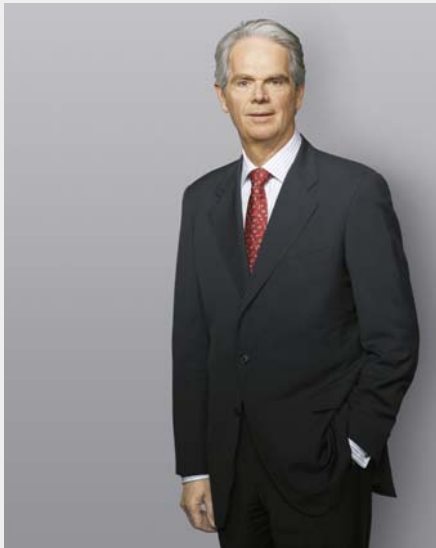

Dr. Peter-Alexander Wacker

Dear Shareholders,

2008 was another successful year for the WACKER Group. In spite of the second half-year's global economic difficulties, sales and EBITDA outperformed the prior-year levels and set new records. With investments at over €1 billion, WACKER entered a new dimension. Although the Group invested substantially more, it succeeded in financing itself without outside help.

The Supervisory Board supported the Executive Board in its successful work during 2008, offering advice on all key issues. To enable WACKER to continue seamlessly building on the good results of past years, the Supervisory Board approved projects that offer WACKER additional growth opportunities.

In 2008, we discharged all the duties incumbent on us by law and under the Group's Articles of Incorporation and Rules of Procedure. We continuously monitored the activities of the Executive Board and extensively advised it on the management of the Group and business operations. The Supervisory Board was involved in every decision of fundamental significance for the Group at an early stage.

In both written and oral reports, the Executive Board regularly provided us with timely and comprehensive information on corporate planning, strategic development, business operations and the current state of Wacker Chemie AG and the Group, including the risk situation. Actual deviations from business plans and targets were explained to us in detail. Where required by statutory provisions and the Articles of Incorporation, the Supervisory Board voted on the reports and proposals of the Executive Board after detailed examination and discussion. Outside the scheduled Supervisory Board meetings, the Supervisory Board chairman remained in regular contact with the Executive Board, especially its president, and was kept informed about the current business situation and key business transactions.

Six Supervisory Board meetings were held in 2008 – three in the first half-year (including the newly elected Supervisory Board's constituent session) and three in the second. Between meetings, the Executive Board informed us in detail by means of written reports about all projects and plans of particular importance to the Group.

The Supervisory Board's Main Areas of Deliberation

The development of sales, earnings and employment in the Group and its individual segments were the subject of regular deliberations at our plenary meetings. At each meeting, the Supervisory Board evaluated the Executive Board's performance – on the basis of Executive Board reports – and discussed strategic growth opportunities and other key topics with the Executive Board. There wasn't a need for additional monitoring measures, such as inspection of corporate documents or expert counsel. The plenary meetings were prepared by shareholder and employee representatives in their own separate sessions. In the period under review, every Supervisory Board member attended at least half of the meetings held during their term.

The chief issues that the Supervisory Board deliberated on were:

- Constructing a polysilicon production plant at Nünchritz,
- The integration and reorganization measures relating to the Group's all-share acquisition of its joint ventures with Air Products and Chemicals, Inc.
- Expanding and capitalizing Siltronic AG's joint venture with Samsung Electronics Asia Holding Pte Ltd.,
- Increasing our production capacities at Burghausen, Nanjing, Zhangjiagang, Singapore and Jena,
- The impact of the global financial crisis on WACKER's development, especially with respect to the strategic investment plans, the future liquidity position and the financing.

At its meeting of December 11, 2008, the Supervisory Board discussed the WACKER Group's fiscal 2009 planning, as well as medium-term plans until 2012. The Supervisory Board approved both sets of planning data. It also approved the 2009 capital expenditure budget.

Work in the Committees

The Supervisory Board is assisted in its work by Supervisory Board committees. WACKER's Supervisory Board has created three committees – an Audit Committee, an Executive Committee, and a Mediation Committee (as per the German Co-Determination Act [MitbestG], Section 27, Subsection 3). The Audit Committee is chaired by Dr. Bernd W. Voss. The other two are chaired by the Supervisory Board chairman.

The Audit Committee met four times in 2008. Key aspects of its work included thorough audits of 2007's financial statements for Wacker Chemie AG and the Group, and the consolidated financial statements for the first half-year. The Audit Committee also discussed the consolidated quarterly reports and looked at risk-management and compliance issues. In addition, the Audit Committee oversaw cooperation with WACKER's independent auditor.

The Executive Committee met twice in 2008. In its meetings, it handled personnel issues relating to the Executive Board.

The Mediation Committee did not need to be convened in the year under review.

The Supervisory Board was regularly informed of the committees' work.

Corporate Governance

In its meeting of December 11, 2008, the Supervisory Board dealt with the Group's implementation of corporate governance principles. At this meeting, the Supervisory and Executive Boards passed the annual Declaration of Conformity – as per § 161 of Germany's Stock Corporation Act (AktG). The Declaration of Conformity has been published online, where it is permanently available to shareholders. → www.wacker.com

→ More information about corporate governance at WACKER appears on page 200

At its December meeting, the Supervisory Board also reviewed the efficiency of its own activities – arriving at a positive evaluation.

Audit of the Annual Financial Statements of Wacker Chemie AG and the WACKER Group

KPMG AG Wirtschaftsprüfungsgesellschaft (Berlin) audited the annual financial statements (reporting date: December 31, 2008) and the management reports of Wacker Chemie AG and the WACKER Group (including its accounting system) and approved them without qualification. Said financial statements and management reports had been prepared by the Executive Board as per IFRS regulations. The audit contract had been awarded by the Supervisory Board's Audit Committee in line with the resolution of the Annual Shareholders' Meeting of May 8, 2008.

The auditors also examined the Group's risk management system in accordance with Section 91 of Germany's Stock Corporation Act. The audit verified that the risk management system meets legal requirements. No material business risks were identified. Financial-statement documents (including the auditor's report, the management reports and the Executive Board's appropriation-of-profits proposal) were submitted to all Supervisory Board members in a timely manner.

At its meeting of March 4, 2009, the Audit Committee closely examined the above-mentioned statements and reports, and the reports submitted by the (parent-company and Group) auditing team, which was present. The committee thoroughly discussed said information with the auditors, and reported in full to the whole Supervisory Board. At its meeting of March 12, 2009, the whole Supervisory Board intensively discussed and examined the relevant financial statements and reports, giving all due consideration to the reports made by the Audit Committee and auditors. At both meetings, the auditors took part in the deliberations. They reported on the main results of the audit and were available to the Audit Committee and the entire Supervisory Board to answer questions and provide supplementary information.

After concluding our own examination, we found no grounds for disputing the financial statements and management reports of either Wacker Chemie AG or the Group, or the auditor's report.

Accordingly, we concur with the audit's result. The financial statements of both Wacker Chemie AG and the WACKER Group – as submitted by the Executive Board as per December 31, 2008 – are hereby approved. Wacker Chemie AG's financial statements are thus finalized. We approve the Executive Board's profit-appropriation proposal.

Changes in the Composition of the Supervisory and Executive Boards

New Supervisory Board shareholder representatives were elected at the Annual Shareholders' Meeting on May 8, 2008. Wacker Chemie AG employees had elected their employee representatives on March 6, 2008. The Annual Shareholders' Meeting was followed by the Supervisory Board's constituent session, at which Dr. Peter-Alexander Wacker was appointed as the new Supervisory Board Chairman. Having reached the age limit for Supervisory Board members, the previous chairman, Dr. Karl Heinz Weiss, was not eligible for reelection.

Dr. Peter-Alexander Wacker stepped down as President & CEO of Wacker Chemie AG at the end of the Annual Shareholders' Meeting on May 8, 2008. He also ceased to be a member of WACKER's Executive Board.

Dr. Rudolf Staudigl became the new President & CEO at the end of the Shareholder Meeting on May 8, 2008. Dr. Staudigl has been a member of WACKER's Executive Board since 1995. The Supervisory Board extended his contract for a further five years.

At its session on March 12, 2008, the Supervisory Board decided to appoint Dr. Wilhelm Sittenthaler as a further Executive Board member, likewise effective at the end of the Annual Shareholders' Meeting on May 8, 2008. Dr. Wilhelm Sittenthaler was President & CEO of Siltronic AG, a wholly-owned subsidiary of Wacker Chemie AG. From 2000 to 2002, he had been a member of the Executive Board of Wacker-Chemie GmbH. His contract runs until 2013. At the same meeting, the Supervisory Board had also extended the contract of Executive Board member Auguste Willems by a further five years until 2013.

The Supervisory Board expresses its thanks to the Executive Board and to the company's employees and employee representatives. Their efforts have helped achieve another successful year for Wacker Chemie AG.

Munich, March 12, 2009
The Supervisory Board



Dr. Peter-Alexander Wacker
Chairman

Wacker Chemie AG attaches great importance to the rules of proper Corporate Governance. With a few exceptions, we comply with the recommendations contained in Germany's Corporate Governance Code. The exceptions are listed in the following declaration of conformity (issued December 11, 2008 by the Executive Board and Supervisory Board in accordance with § 161 of the German Stock Corporation Act (AktG)).

Declaration of Conformity 2008 by the Executive Board and the Supervisory Board of Wacker Chemie AG

1 General Declaration Pursuant to § 161 German Stock Corporation Act

In December 2007, the Executive Board and the Supervisory Board of Wacker Chemie AG issued the last declaration of conformity pursuant to § 161 German Stock Corporation Act. Since that time, Wacker Chemie AG has complied with the recommendations of the German Corporate Governance Code (Code) as amended on June 14, 2007 with the following exceptions (not including lit. d) and will comply with the recommendations of the Code as amended on June 6, 2008, except as follows:

2 Exceptions

a D&O Insurance - Deductible

D&O insurance/policy effected for the corporation's board members or employees acting as a management body does not include a deductible for the individual.

b Corporate Governance Report

A report on the corporation's corporate governance by the Executive Board and the Supervisory Board shall be included in the annual report. This report shall also include an explanation of any deviation from the recommendations of the Code. Such report is regulated by § 161 German Stock Corporation Act which partially varies from the Code in regards to content.

The Executive Board and the Supervisory Board have decided to execute a declaration solely in accordance with the legal provisions. To that effect, we depart from the recommendations of the Code in regards to content and form of the Corporate Governance Report.

c Regular review and resolution concerning the Executive Board's compensation system structure by the full Supervisory Board

The structure of the Executive Board's compensation system, including the essential contract components, is reviewed regularly and decided upon by the Executive Committee. A report detailing the activities of the Supervisory Board committees, including the activities of the Executive Committee, is given regularly in the plenary meeting of the Supervisory Board. If and to the extent that the recommendation of the Code goes beyond the aforementioned reporting, we do not comply.

d Severance pay cap

With regard to new appointments to the Executive Board as well as the reappointment of Executive Board members, we will comply with this recommendation of the Code.

e Information regarding the main features of the Executive Board's compensation system at the Annual Shareholders' Meeting

Our annual report includes extensive information, including facts about the Executive Board's compensation system for our shareholders. We regard any further proactive measures as unnecessary.

f Announcement of proposed candidates for the chair of the Supervisory Board to the shareholders

This recommendation states that shareholders are to be informed of any candidates for the Supervisory Board chair, even though the Supervisory Board usually still has to be appointed. Under German law, the Supervisory Board chair is to be chosen by, and from among, the Supervisory Board members. There is currently no legal requirement to announce the candidates for the chair from among a group of as-yet unappointed Supervisory Board members. Furthermore, this would, above all, result in a de facto predetermination which is also not provided for under German law. For these reasons, we do not comply with this recommendation.

g Transfer of Executive Board members to the Supervisory Board, taking the chair of the Supervisory Board or the chair of committees

In our opinion, it may very well make sense for former members of the Executive Board to join the Supervisory Board and also to chair the Supervisory Board or various specific committees. In fact, the knowledge of former Executive Board members about the company increases the efficiency of control exercised by the Supervisory Board. We do not see any disadvantage in a Supervisory Board which, in accordance with the Code, is well-balanced with respect to its members. As we do not agree with this recommendation we do not comply with it.

h Formation of a Nomination Committee within the Supervisory Board

The Supervisory Board is to establish a Nomination Committee which is exclusively composed of shareholder representatives. The committee's task is to make recommendations to the Supervisory Board with regard to suitable candidates for proposal to the Annual Shareholders' Meeting. We do not comply with this recommendation as we do not believe such a committee to be necessary.

Compensation Report

Compensation Report for the Executive Board

The Supervisory Board's Executive Committee is responsible for determining the compensation paid to the Executive Board of Wacker Chemie AG. In the 2008 fiscal year, the Executive Board's compensation was comprised of the following significant components:

(I) A fixed annual salary:

The fixed annual salary is paid monthly in identical installments.

(II) A variable, performance-related bonus:

The amount of the variable bonus, which is paid retrospectively on conclusion of the fiscal year, depends on the attainment of agreed annual targets of the WACKER Group with regard to the following key indicators: results according to investment outlay, cash flow and target return, as well as individual targets of the Executive Board's members. The bonus is determined annually by the Supervisory Board's Executive Committee after the annual financial statements have been adopted. The members of the Executive Board are entitled to a minimum bonus.

(III) A pension contribution:

The members of the Executive Board acquire entitlement to the payment of an annual retirement pension should the event insured against occur, i.e. when the member in question reaches retirement age or becomes afflicted by permanent occupational disability. Before the event insured against occurs, Dr. Staudigl, Dr. Rauhut, and Dr. Sittenthaler (this also applied for Dr. Wacker, see below) have a basic entitlement to the premature payment of an annual pension if they leave the Executive Board against their will without good cause or if they discontinue their activity for good cause resulting from activity of the Company. The amount of the retirement pension, like the fixed annual salary a performance-unrelated component, is determined by the amount of the last annual salary to be drawn and, typically, the duration of Executive Board membership.

The last adjustment of the fixed annual salary and the variable bonus was made on July 1, 2007. In the case of Dr. Staudigl, moreover, the fixed annual salary was increased when he assumed the new post of President & CEO. The current compensation amounts are presented in the table below.

The Company grants the members of the Executive Board appropriate insurance cover, in particular D&O insurance.

Dr. Wacker stepped down from his post as President & CEO upon conclusion of the Annual Shareholders' Meeting on May 8, 2008 and was elected at the same day as member of the Supervisory Board. Following his election he took over the chairmanship of the Supervisory Board. Due to his premature departure, he first drew his fixed annual salary on a pro rata basis for the first three months before drawing his retirement pension thereafter. Due to a 24-month waiting period obligation that had been agreed, Dr. Wacker is entitled to waiting period compensation, although this will be set off against his retirement pension. Dr. Wacker will additionally be provided with a company car.

Executive Board Compensation

€	Fixed compensation ¹	Variable compensation	Pension ²	Total
Dr. Rudolf Staudigl				
2008	813,548	1,316,848	421,557	2,551,953
2007	569,560	1,055,000	373,375	1,997,935
Dr. Joachim Rauhut				
2008	599,195	1,067,000	213,957	1,880,152
2007	574,086	1,055,000	196,543	1,825,629
Dr. Wilhelm Sittenthaler (from May 8, 2008)				
2008	393,676	711,333	268,429	1,373,438
Auguste Willems				
2008	592,957	811,250	236,498	1,640,705
2007	567,372	870,000	234,733	1,672,105
Dr. Peter-Alexander Wacker (until May 8, 2008)				
2008	322,363	569,875	294,754	1,186,992
2007	851,082	1,582,500	788,703	3,222,285
Total				
2008	2,721,739	4,476,306	1,435,195	8,633,240
2007	2,562,100	4,562,500	1,593,354	8,717,954

Expenses for former Executive Board members and their surviving dependents

€	Total
2008	2,787,599³
2007	817,164

Pension Provisions for Executive Board members

€	Total
Pension provisions for active Executive Board members	
2008	11,882,999
2007	12,357,586
Pension provisions for former Executive Board members and their surviving dependents	
2008	16,446,268
2007	8,639,697

¹The fixed compensation additionally includes the use of a company car.

²The pension includes the interest cost as well as the service cost. The interest cost amounts to €579,989 (2007: €513,791).

³This includes payments to former Executive Board members upon termination of employment contracts in the amount of €1,982,171 (2007: €0).

Compensation Report for the Supervisory Board

The compensation for the members of the Supervisory Board of Wacker Chemie AG is set governed by the articles of incorporation of Wacker Chemie AG.

In return for their work, the members of the Supervisory Board receive fixed annual compensation payable when the fiscal year expires. This annual compensation was increased from €15,000 to €25,000 when the articles of incorporation were amended on May 8, 2008. Supervisory Board members who join the Supervisory Board or depart from the Supervisory Board during the course of the ongoing fiscal year receive the appropriate pro rata compensation.

In addition to their fixed compensation, the members of the Supervisory Board receive performance-related compensation for the past fiscal year based on the percentage return on assets¹ after the annual financial statements have been adopted. The performance-related compensation can be between 0 and 125% of the fixed annual compensation.

The fixed and performance-related compensation is multiplied by the factor 3 for the Chairman of the Supervisory Board, by the factor 2 for the Vice Chairman and for committee chairmen, and by the factor 1.5 for members of committees. This arrangement does not take account of double and multiple functions.

The members of the Supervisory Board are compensated for any outlays incurred in connection with the execution of their duties with an annual lump sum of €12,000 each. They are additionally refunded any VAT payable on their compensation.

The Company grants the members of the Supervisory Board appropriate insurance cover; in particular, the Company concludes a D&O insurance policy for the benefit of the Supervisory Board's members.

Supervisory Board Compensation

€	Fixed compensation	Variable compensation	Total
2008	511,000	393,750	904,750
2007	507,000	393,750	900,750

¹ Definition of the return on assets for this purpose: the percentage ratio of earnings before interest and taxes to the capital employed in accordance with IFRS consolidated financial statements, with the capital employed corresponding to the total of current and noncurrent assets less liquidity.

Declaration by the Executive Board on the Accounting Methods and Auditing

The Executive Board is responsible for preparing Wacker Chemie AG's consolidated financial statements and Group management report. WACKER's consolidated financial statements were published in compliance with the rules published in London by the International Accounting Standards Board (IASB) and endorsed by the European Union. WACKER has set up effective internal monitoring and steering systems to guarantee that the Group management report and the consolidated financial statements comply with the applicable rules and procedures of proper corporate reporting. The implementation of and/or compliance with the Group's uniform guidelines for accounting and financial reporting, as well as the reliability and operability of the monitoring and steering systems are continuously checked by the Group's internal auditors around the world. KPMG AG Wirtschaftsprüfungsgesellschaft has audited Wacker Chemie AG's consolidated financial statements and Group management report and granted them an unqualified audit certificate. WACKER's consolidated financial statements, its Group management report, and the auditor's report were discussed in detail by the Supervisory Board's audit committee at its meeting on March 4, 2009. → With regard to the Supervisory Board's audit, we refer to its report on page 195–199.

Assurance by the legal representatives in accordance with Sections 297 (2), 315 (1), HGB

To the best of our knowledge, and in accordance with the applicable reporting principles, the consolidated financial statements give a true and fair view of the assets, liabilities, financial position and profit or loss of the group, and the group management report includes a fair review of the development and performance of the business and the position of the group, together with a description of the principal opportunities and risks associated with the expected development of the group.

Munich, Germany, February 20, 2009
Wacker Chemie AG

Rudolf Staudigl

Wilhelm Sittenthaler

Joachim Rauhut

Auguste Willems

Auditor's Report

206 Consolidated Financial Statements ...// Auditor's Report

We have audited the consolidated financial statements prepared by the Wacker Chemie AG, Munich, comprising the balance sheet, the income statement, the statement of comprehensive income, statement of changes in equity, cash flow statement and the notes to the consolidated financial statements, together with the group management report for the business year from January 1 to December 31, 2008. The preparation of the consolidated financial statements and the group management report in accordance with IFRSs, as adopted by the EU, and the additional requirements of German commercial law pursuant to § 315a Abs. 1 HGB (Handelsgesetzbuch "German Commercial Code") are the responsibility of the parent company's management. Our responsibility is to express an opinion on the consolidated financial statements and on the group management report based on our audit.

We conducted our audit of the consolidated financial statements in accordance with § 317 HGB (Handelsgesetzbuch "German Commercial Code") and German generally accepted standards for the audit of financial statements promulgated by the Institut der Wirtschaftsprüfer (Institute of Public Auditors in Germany) (IDW). Those standards require that we plan and perform the audit such that misstatements materially affecting the presentation of the net assets, financial position and results of operations in the consolidated financial statements in accordance with the applicable financial reporting framework and in the group management report are detected with reasonable assurance. Knowledge of the business activities and the economic and legal environment of the Group and expectations as to possible misstatements are taken into account in the determination of audit procedures. The effectiveness of the accounting-related internal control system and the evidence supporting the disclosures in the consolidated financial statements and the group management report are examined primarily on a test basis within the framework of the audit. The audit includes assessing the annual financial statements of those entities included in consolidation, the determination of entities to be included in consolidation, the accounting and consolidation principles used and significant estimates made by management, as well as evaluating the overall presentation of the consolidated financial statements and group management report. We believe that our audit provides a reasonable basis for our opinion.

Our audit has not led to any reservations.

In our opinion, based on the findings of our audit, the consolidated financial statements comply with IFRSs, as adopted by the EU, the additional requirements of German commercial law pursuant to § 315a Abs. 1 HGB and give a true and fair view of the net assets, financial position and results of operations of the Group in accordance with these requirements. The group management report is consistent with the consolidated financial statements and as a whole provides a suitable view of the Group's position and suitably presents the opportunities and risks of future development.

Munich, February 23, 2009
KPMG AG Wirtschaftsprüfungsgesellschaft

Kozikowski
Auditor

Dr. Grottel
Auditor

B

Biologics...// Therapeutically effective proteins (pharmaceutical proteins) that, unlike traditional pharmaceutical actives, are bioengineered and can help in the diagnosis, cure or prevention of diseases.

Biotechnology...// Biotech processes use living cells or enzymes to transform and produce substances. Depending on the application, a distinction is made between red, green and white biotechnology. Red biotechnology: medicinal-pharmaceutical applications. Green biotechnology: agricultural applications. White biotechnology: biotech-based products and industrial processes, e.g. in the chemical, textile and food industries.

D

Dispersion...// Binary system in which one component is finely dispersed in another. VINNAPAS® dispersions from WACKER are vinyl-acetate-based binary copolymers and terpolymers in liquid form. They are mainly used as binders in the construction industry, e.g. for grouts, plasters and primers.

Dispersible powders...// Created by drying dispersions in spray or disc dryers. VINNAPAS® polymer powders from WACKER are recommended as binders in the construction industry, e.g. for tile adhesives, self-leveling compounds and repair mortars. The powders improve adhesion, cohesion, flexibility and flexural strength, as well as water-retention and processing properties.

P

Polymer ...// Polymers are large molecules made up of smaller molecular chains (monomers). A polymer contains between 10,000 and 100,000 monomers. Polymers can be long or ball-shaped.

Polysilicon...// Hyperpure polycrystalline silicon from WACKER POLYSILICON is used for manufacturing wafers for the electronics and solar industries. To produce it, metallurgical-grade silicon is converted into liquid trichlorosilane, highly distilled and deposited in hyper-pure form at 1,000 °C.

C

Chlorosilane...// A compound of silicon, chlorine and hydrogen. In the semiconductor industry, mainly trichlorosilane is used to make polysilicon and for the epitaxial deposition of silicon.

E

Elastomers...// Polymers that exhibit almost perfectly elastic behavior, i.e. they deform when acted upon by an external force and return to their exact original shape when the force is removed. While the duration of the force has no effect on perfectly elastic behavior, the temperature does.

S

Silicon wafer...// A silicon wafer is a circular disc with a thickness of between approximately 200 and 800 µm, and is used by the semiconductor industry for the manufacture of semiconductor devices, i.e. integrated circuits and discrete components.

Silicone...// General term used to describe compounds of organic molecules and silicon. According to their areas of application, silicones can be classified as fluids, resins or rubber grades. Silicones are characterized by a myriad of outstanding properties. Typical areas of application include construction, the electrical and electronics industries, shipping and transportation, textiles and paper coatings.

Pyrogenic silica...// White, synthetic, amorphous silicon dioxide (SiO₂) in powder form, made by flame hydrolysis of silicon compounds. It is versatile in applications as an additive for silicone rubber grades, sealants, surface coatings, pharmaceuticals and cosmetics.

Siloxane...// Systematic name given to compounds comprising silicon atoms linked together via oxygen atoms and with the remaining valences occupied with hydrogen or organic groups. Siloxanes are the building blocks for the polymers (polysiloxane and polyorganosiloxane) that form silicones.

Cyclodextrins...// Cyclodextrins belong to a family of cyclic oligosaccharides (i.e. ring-shaped sugar molecules). Cyclodextrins are able to encapsulate fragrances or release active ingredients at a controlled rate. WACKER FINE CHEMICALS produces and markets cyclodextrins.

Cysteine...// Cysteine is a sulfur-containing amino acid. It belongs to the non-essential amino acids because it can be formed in the body. It is used, for example, as an additive in food and cough-syrup mixtures. Cysteine and its derivatives are a business field at WACKER FINE CHEMICALS.

Ethylene...// Ethylene is a colorless, highly reactive gas and a key chemical-industry raw material.

G

Good Manufacturing Practice (GMP) ...// GMP is a general term used to describe a collection of rules and stipulations that must be complied with when specific products are manufactured and handled in order to safeguard their quality. GMP Guidelines are issued by bodies such as the U.S. Food and Drug Administration (FDA) and the EU.

I

Ingredients...// Constituents or additives (in foodstuffs, pharmaceutical products, etc.).

S

Semiconductor...// A substance whose electrical conductivity is much lower than that of metals but increases dramatically as the temperature rises. Semiconductors can be modified for a particular purpose by doping with foreign atoms.

Silanes...// Silanes are used as monomers for the synthesis of siloxanes or sold directly as reagents or raw materials. Typical applications include surface treatment, reagents in pharmaceutical synthesis or coupling agents for coatings.

Silicon...// After oxygen, the most common element on the planet. In nature, silicon occurs without exception in the form of compounds, chiefly silicon dioxide and silicates. Silicon is obtained through energy-intensive reaction of quartz sand with carbon and is the most important raw material in the electronics industry.

V

VINNAPAS® ...// VINNAPAS® is the name of WACKER's product line of dispersions, polymer powders, solid resins and their associated product solutions. VINNAPAS® dispersions and polymer powders are primarily used in the construction industry as polymeric binders, e.g. in tile adhesives, exterior insulation and finish systems, self-leveling compounds, and plasters.

B

Business Value Contribution

(BVC)...// BVC is a financial performance measurement that determines the value created by the WACKER Group and its units once all capital costs have been deducted. BVC is the difference between profit (EBIT) and the weighted average cost of capital (WACC x CE). BVC is a profit variable that is adjusted to allow for extraordinary effects (e.g. sale of parts of the company). This makes it an ideal tool for measuring business performance.

C

Capital Employed (CE)...// Made up of average fixed assets, assets under construction, inventories and receivables. It is a variable used in calculating the cost of capital (WACC x CE).

Cash flow...// Cash flow represents the internal financing potential of the company, i.e. the company's solvency. It reflects the net payments received within a specific period, with gross cash flow being the amount earned from operations and net cash flow being the amount remaining after deducting investment expenses.

E

EBIT...// Earnings before interest and taxes: EBIT is a good indicator for comparing companies' profitability, since it is widely used across the corporate world.

EBITA...// Earnings before interest, taxes, depreciation and amortization = EBIT + actual depreciation.

Equity Capital Ratio...// The equity capital ratio is calculated from the ratio of equity capital to a company's total assets. It indicates the level of economic and financial stability at a company.

I

IFRS...// The International Financial Reporting Standards (until 2001 International Accounting Standards, IAS) are international accounting standards compiled and published by the London-based "International Accounting Standards Board" (IASB). Since 2005, publicly-listed EU-based companies have been required to use the IFRS in accordance with IAS regulations.

R

ROCE...// Return on capital employed: profitability ratio relating to the capital employed.

Index

A – Z

Annual Report 2008

Wacker Chemie AG

211

A

accounting and valuation methods	131, 140
accounting principles	131, 140
advance training	92, 105
annual financial statements	198
associated companies / joint ventures	67, 68, 143, 151, 188
auditor's report	206

B

balance sheet	67, 70, 122, 123
---------------	------------------

C

cash flow	71, 72, 185
compensation report	202
consolidated income statement, notes	204
corporate governance	197, 200
currency translation	69, 139, 184

D

depreciation / amortization	71, 128, 129, 142, 155–160
dividend	38, 63, 73, 179

E

earnings per share	36, 179
EBIT	66, 121
EBITDA	63, 64, 66, 67
economy	59, 63, 101, 111
education / training	91
employees	90–93, 105, 115, 116
environmental protection	50, 53, 95, 97, 103, 117
equity	66, 69, 126, 127
executive board	40, 45, 46, 194, 199, 202, 205

F

financial assets	71
financial liabilities	69, 71, 102, 146, 174, 181
financial situation	71, 115
financing measures	52, 71, 102, 106, 115

G

glossary	208–210
group structure	43, 45

I

income statement	67, 121
innovations	49, 83–86
intangible assets	70, 122, 141, 157
interest result	66, 151, 184
inventories	68, 143, 163
investments / CAPEX	63, 72
investor relations	39, 40

L

liabilities	69, 175
liquidity / cash and cash equivalents	53, 68, 69, 71–73, 102, 166, 184

M

management report	43
-------------------	----

N

notes	131
-------	-----

O

organizational structure	47
other operating expenses	66, 121, 149, 150
outlook	109

P

personnel	90–93, 105, 115, 116
personnel development	92
personnel expenses	90, 91, 178
procurement	86–89, 101, 116
products	43, 47, 84–86, 109
property, plant and equipment	68, 72, 142, 159, 160
provisions and accruals	172–174
provisions for pensions	69, 146, 168–172

R

rating	53, 73
report of the supervisory board	195
research and development	83–86, 115
risk report	99
risk management system	99, 100

S

sales development	62, 65, 66, 82, 118
scope of consolidation	135
segment reporting	76–81, 128–130, 186
share	35–40, 179
share performance	37
Siltronic	47, 48, 55, 65, 76, 81, 84
sites	43, 44
social commitment	98
social responsibility	98
statement of cash flows	71, 72
stock / share price	36, 179
strategy	52, 54–56
supervisory board	45, 46, 63, 192, 193, 195
supplementary report	106
sustainability	94, 117

T

takeover directive implementation act	74, 75
technical centers	43

V

value-based management	51, 52
------------------------	--------

W

WACKER FINE CHEMICALS	48, 49, 56, 65, 80, 81
WACKER POLYMERS	47–49, 55, 62, 65, 78, 79, 81
WACKER POLYSILICON	47–49, 56, 62, 65, 79, 80, 81
WACKER SILICONES	47, 48, 55, 65, 77, 81, 85

Our Annual Report is available in German and English, you'll find both versions online at www.wacker.com/annual-report.

This Annual Report contains forward-looking statements based on assumptions and estimates of WACKER's Executive Board. Although we assume the expectations in these forward-looking statements are realistic, we cannot guarantee they will prove to be correct. The assumptions may harbor risks and uncertainties that may cause the actual figures to differ considerably from the forward-looking statements. Factors that may cause such discrepancies include, among other things, changes in the economic and business environment, variations in exchange and interest rates, the introduction of competing products, lack of acceptance for new products or services, and changes in corporate strategy. WACKER does not plan to update the forward-looking statements, nor does it assume the obligation to do so.

The English Annual Report is a translation of the German version. Only the original German version is binding.

...// Financial Calendar 2009

Apr. 29

Q1 2009 Report
(January to
March)

May 8

Annual Share-
holder Meeting
in Munich,
Germany

Jul. 30

Q2 2009 Report
(April to June)

Nov. 5

Q3 2009 Report
(July to
September)

...// Contact

Investor Relations

Jörg Hoffmann, Head of Investor Relations
Tel. +49 89 6279-1633
joerg.hoffmann@wacker.com

Media Relations

Christof Bachmair
Tel. +49 89 6279-1830
christof.bachmair@wacker.com

...// Imprint

Editor

Wacker Chemie AG
Corporate Communications
Hanns-Seidel-Platz 4
81737 München, Germany
Tel. +49 89 6279-0
Fax +49 89 6279-1770
www.wacker.com

Concept and Design

häfelinger + wagner design
www.hwdesign.de



Wacker Chemie AG Hanns-Seidel-Platz 4, 81737 München, Germany, Tel. +49 89 6279-0, Fax +49 89 6279-1770, www.wacker.com